

Order spare parts under correct spare part codes

Content

1. General spare parts	2
Thermostats and dails	2
Electrical wiring and end switches	4
Connectors	5
Pocket and fuse and switches	7
Capacitors and fans	8
Impellers	10
Gasket for fans	11
Air regulating flaps, draught regulator FR124	12
Servo-actuators	13
Doors, hinges	14
Sealing cord, door closure	15
Door insulation, insulation under burners	16
Lids	19
Firing up (ignition) flaps and rods	21
Dash boards and hoods	23
Shields	25
Waste gas brakes	26
Pockets, cement	28
Spare parts for boilers with automatic wood ignition - AIW	30
2. Wood gasification DCxxS, GS, wood burning Dxx, pellet DxxP or natural gas or LFO boilers typ EP(L), SP(L), GSP(L)	42
Ceramic - roofs, spherical chambers	42
Nozzles, combustion chamber ceramic	43
Sealing cords	47
Nozzles	48
Spherical chambers	49
Sides of combustion chamber	51
3. Gasification boilers for coal and wood CxxS(T), lignite briquets AC/KCxxS and wooden briquets DCxxRS	52
Ceramic - spherical chambers	52
Grates	53
Grate tubes, grate bar and ceramic DCxxRS	54
4. Accessories	58
Thermostat for putting on pipe, dual thermostats	58
Manometers and thermometers	59
Flue ways and draught regulator (reducer) for chimney	60
Cleaning sets and ashtrays	61
Thermoregulating valves, Three-way mixer and Four-way mixers, actuator	62
Laddomat 21,22	63
Pumps, stopvalve with a switch, thermostatic valves for cooling loop	64
Equithermal controller, GSM module-controller	66
Controller AC19, Modules (AD01, AD02, AD03, AD04, AD08)	68
5. Pellet tanks	69
Pellet tanks - 250, 500, 1000 liters	69
Compact pellet tanks AZPD and AZPU with conveyors DRA25	70
Conveyors for compact pellet tanks AZPD/AZPU	71
Pellet tank for boilers DxxPX, PXxx, conveyor for boilers DxxPX, PXxx	72
6. Accumulation tanks - DH / DZ	73
7. ATMOS A25 pellet burner	76
Special parts for A25 pellet burner	84
- in a version for DCxxGSP boiler,	84
- in a version for DCxxSP, CxxSP boilers - Model 2018	84
Parts for pneumatic cleaning of the ATMOS A25 pellet burner	86
8. ATMOS A45 pellet burner	88
Parts for pneumatic cleaning of the ATMOS A45 pellet burner	96
9. ATMOS A85 pellet burner with pneumatic cleaning	98
10. IWABO pellet burner	107
11. ERATO GP20 pellet burner	110
12. ATMOS A50 pellet burner	113
13. Automatic ash removal for DxxP boilers	118
14. Pneumatic pellet feeding APS 250 (S) (SPX) / APS 500	121
15. LFO and Natural gas burners	127
16. Textile pellet silos ATZ	128
17. External combustion air supply for ATMOS A25 burner	130
18. The Connection of ATMOS Fxx, Compact boilers	132
Accessories for boilers up to 40 kW with manual stoking Connection of ATMOS boilers F1-F8	150
Accessories for Connection of ATMOS pellet boilers up to 25 kW DxxPX, PXxx (F15-F18), DxxP Compact, Pxx Compact	151
Special accessories for extending the Connection of boilers	152

1. General spare parts



Regulating boiler thermostat – controls fan

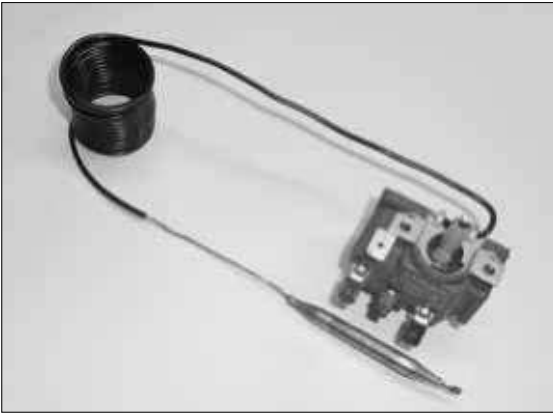

Without knob

Code: S0021 40 - 95 °C – all boilers - standard type	<i>Price:</i>
	<i>Weight: 0,10 kg</i>
Code: S0024 40 - 95 °C – for DC75SE with a longer capillary	<i>Price:</i>
	<i>Weight: 0,10 kg</i>
Code: S0022 to 110 °C – suitable for fitting boilers with buffer tanks	<i>Price:</i>
	<i>Weight: 0,10 kg</i>
Code: S0025 to 110 °C - for DC75SE - longer capillary (Swedish performance)	<i>Price:</i>
	<i>Weight: 0,10 kg</i>

Regulating boiler pump thermostat

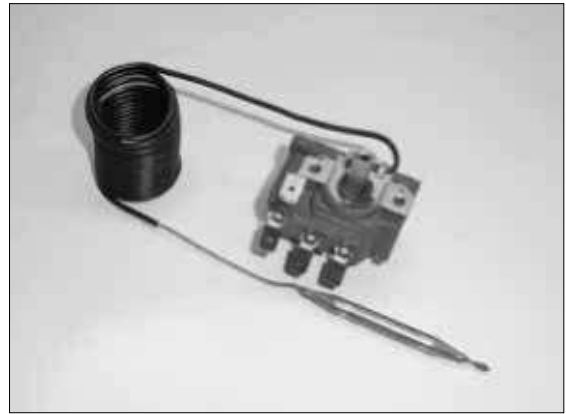

Without knob

Code: S0023 twith three pins with shaft for knob 0 - 95 °C - for boilers DC15E, D15, D20, D30, D15P, D20P, D30P, D40P, D50P, P15, P20, P30, P40, P50, DC15EP(L), DC14R	<i>Price:</i>
	<i>Weight: 0,10 kg</i>
Code: S0062 with three pins without shaft (controlled by screw driver) 0 - 95 °C - for boilers DC18SP(L), DC25SP(L), DC32SP(L), CxxSP(L), KCxxSP(L)	<i>Price:</i>
	<i>Weight: 0,10 kg</i>

Waste gas thermostat



Code: S0031 -15 to 300 °C - switches off ventilator after fuel has been burned out	<i>Price:</i>
	<i>Weight: 0,10 kg</i>
Code: S0019 -15 to 300 °C – for DC75SE – with a longer capillary	<i>Price:</i>
	<i>Weight: 0,10 kg</i>
Code: S0034 tool kit for upgrading old boiler and installing waste gas thermostat	<i>Price:</i>
	<i>Weight: 0,10 kg</i>
Code: S0078 double-circuit from 2012 (from sn 242400) DCxxSP(L), DCxxGSP(L), CxxSP(L), AC/KCxxSP(L), boilers with modification for burner - model 2017 (AC03)	<i>Price:</i>
	<i>Weight: 0,10 kg</i>

Waste gas thermostat without shaft (0 - 300°C)

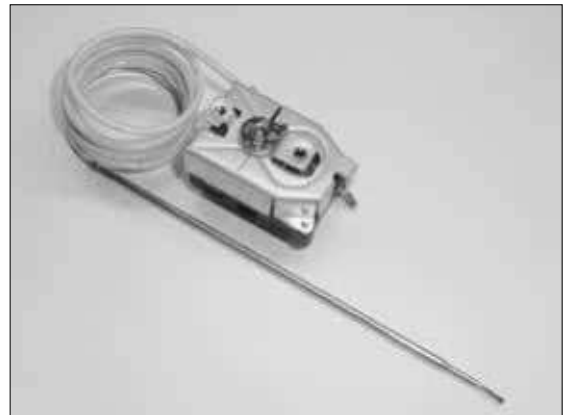

Code: S0020 it serves to close the servomotor Belimo when exceeding the set temperature of waste gas - for DC18GSE - DC50GSE, DCxxGD, DCxxGSP(L)	<i>Price:</i>
	<i>Weight: 0,08 kg</i>

Safety irreversible thermostat

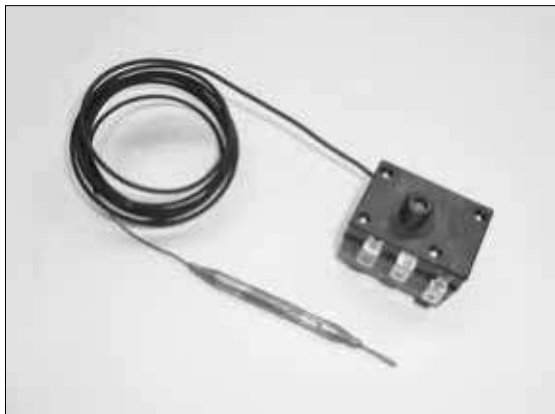

Code: S0061 90 - 110 °C one-circuit - standard - built in the main control panel of the boiler	<i>Price:</i> <i>Weight:</i> 0,12 kg
Code: S0059 90 - 110 °C - dual-circuit DxxPX, PXxx - with a longer capillary	<i>Price:</i> <i>Weight:</i> 0,12 kg
Code: S0068 90 - 110 °C - dual-circuit - built in the main control panel of the pellets boilers DxxP, DCxxSP(L)/EP(L) from serial number 168800, DCxxGSP(L), CxxSP(L), KCxxSP(L), boilers with modification for burner - model 2017 (2x AC03)	<i>Price:</i> <i>Weight:</i> 0,12 kg

Black Knob



Code: S0032 black knob for boiler ther- mostats in the main control panel	<i>Price:</i> <i>Weight:</i> 0,02 kg
Code: S1506 black knob for regulator AC32 - boilers with AIW	<i>Price:</i> <i>Weight:</i> 0,01 kg

Thermometer

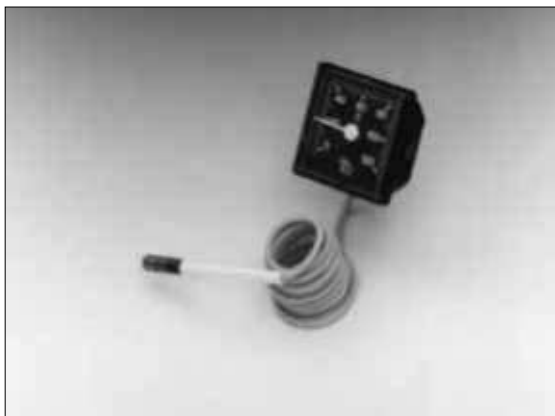

Code: S0041 For all ATMOS boilers	<i>Price:</i> <i>Weight:</i> 0,06 kg
Code: S0056 for DC75SE with a longer capillary	<i>Price:</i> <i>Weight:</i> 0,12 kg

Manometer - DC100



Code: S0044 manometer to the boiler panel DC100, DC105S, DC150S	<i>Price:</i> <i>Weight:</i> 0,10 kg
---	---

Safety reversible thermostat TH480RB



Code: S0051 98 °C – built in boiler – for old boiler types - M22x1,5	<i>Price:</i> <i>Weight:</i> 0,10 kg
--	---

Boiler pump thermostat



Code: S0052 70 °C – preset - old types of boilers - and for boilers DC100, DC105S, DC150, DC75SE DxxPX, PXxx, boilers with modification for burner - model 2017 (AC03) - switching thermostat - M22x1,5	<i>Price:</i> <i>Weight:</i> 0,10 kg
Code: S0053 90 °C (95 °C) – preset - for EU boilers - and for boilers DC100, DC105S, DC150S, DC75SE - recommended accessories for boilers - safety thermostat - M22x1,5	<i>Price:</i> <i>Weight:</i> 0,10 kg

Grommets

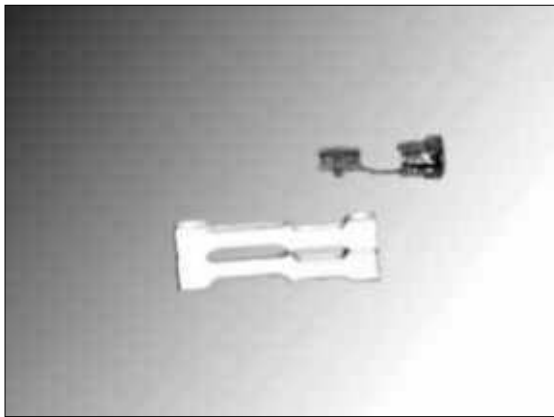

Code: S0185 round grommet

Price:

Weight: 0,04 kg

Code: S0186 flat grommet

Price:

Weight: 0,04 kg

Terminal block – new type

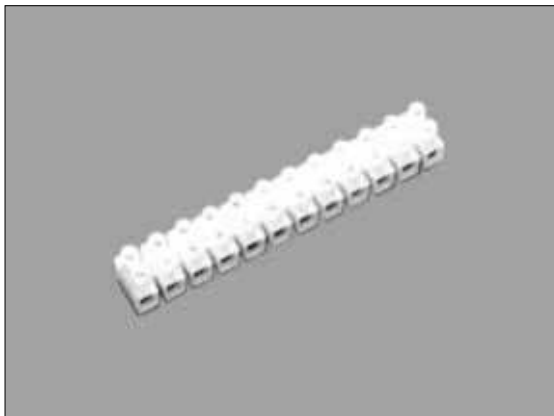

Code: S0182 plastic terminal block

Price:

Weight: 0,08 kg

Set for controlling pump in the primary circuit



Code: S0516 the set is for controlling pump in the primary boiler circuit by waste gas thermostat built in the dash board of the boiler. The set consists of incoming cable with connector and safety thermostat for pump 95 °C

Price:

Weight: 0,28 kg

Electrical wiring

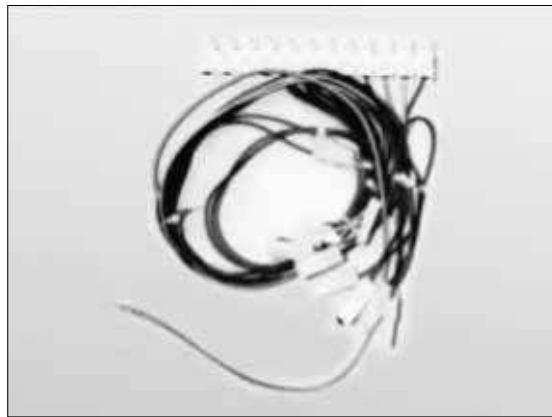

Shown in table no. 1 page 32

Connecting cabling with terminal box for all types of currently produced types of boilers including cable to the fan

Code: S0631 Flexa wire 2,8 m - power cord with plug

Price:

Weight: 0,17 kg

Code: S0715 2.5 m power cord with **3-pin connector** for connection of the boiler or pump - **new version**

Price:

Weight: 0,15 kg

End switch with a reversible button



Code: S0094 for DC15EP(L), DCxxSP(L), DCxxGSP(L), CxxSP(L), AC/KCxxSP(L)

Price:

Weight: 0,10 kg

End switch – DC100



Code: S0075 only for DC100 boilers , DC105S, DC150S

Price:

Weight: 0,22 kg

Connectors for electricity income from 1.2.2008

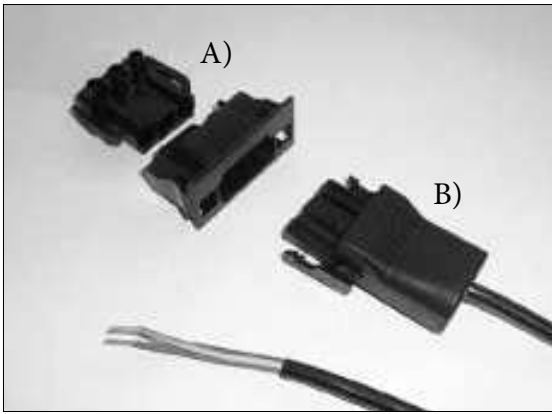

Code: S0641 A) male connector with bushing	<i>Price:</i>
	<i>Weight: 0,01 kg</i>
Code: S0640 B) female connector for cable	<i>Price:</i>
	<i>Weight: 0,01 kg</i>
Code: S0715 incoming cable 2,5 m with connector type B) (S0640)	<i>Price:</i>
	<i>Weight: 0,15 kg</i>

Connector for automatic ash remover - red

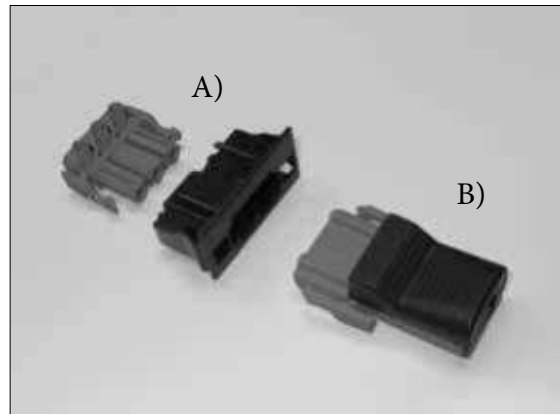

Code: S1102 A) female connector with bushing into the boiler side hood for automatic ash remover - red - 3 pin - pellet boilers DxxP, Pxx	<i>Price:</i>
	<i>Weight: 0,01 kg</i>
Code: S1103 B) male connector for cable - 3 pin	<i>Price:</i>
	<i>Weight: 0,01 kg</i>

Connector for boilers DCxxGSP(L)

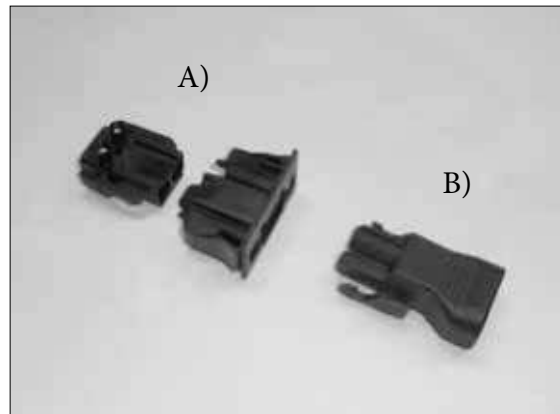

Code: S1092 A) male connector with bushing - in boiler side hood for R3 and R4 support outputs of ventilator - 2 pin - for boilers DCxxGSP(L)	<i>Price:</i>
	<i>Weight: 0,01 kg</i>
Code: S1093 B) female connector for cable - 2 pin	<i>Price:</i>
	<i>Weight: 0,01 kg</i>

Connector for pump in boiler circuit - white

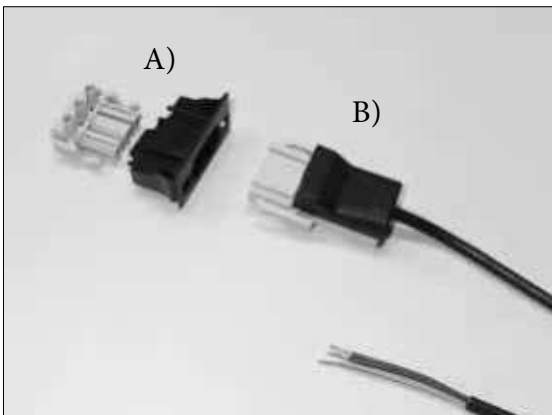

Code: S0642 A) female connector with bushing into the boiler side hood for pump connection in boiler circuit - white - 3 pin	<i>Price:</i>
	<i>Weight: 0,01 kg</i>
Code: S0644 B) male connector for cable - 3 pin	<i>Price:</i>
	<i>Weight: 0,01 kg</i>
Code: S0716 B) male connector with cable - cable length 2,5 m	<i>Price:</i>
	<i>Weight: 0,14 kg</i>

R3 and R4 connecting cable for boilers DCxxGSP



Code: S1084 additional connecting cable with 2-pin connectors (S1091 and S1093) R3 and R4 between boiler and burner	<i>Price:</i>
	<i>Weight: 0,16 kg</i>

Connectors for boilers with burner - pellet, heating oil or gas - into the boiler side hood

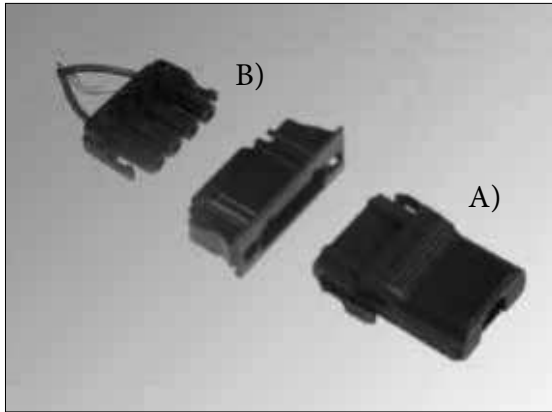

Code: S0633 A) male connector - 4-pin	Price:
	Weight: 0,02 kg
Code: S0632 B) female connector - 4-pin	Price:
	Weight: 0,02 kg
Code: S0901 A) male connector - 5-pin	Price:
	Weight: 0,02 kg
Code: S0913 B) female connector - 5-pin	Price:
	Weight: 0,02 kg

Connector - bypass for pellet boilers

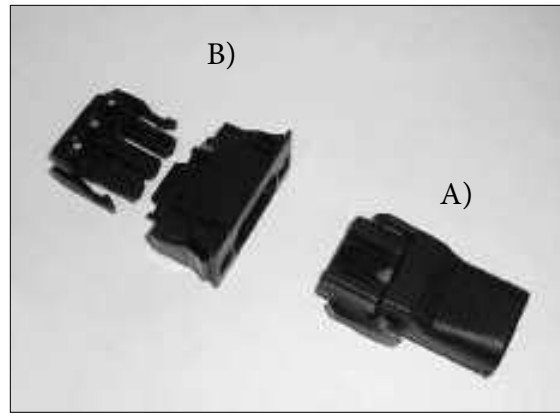

Code: S0648 A) male - connector with bypass (jumper) - 3 pin	Price:
	Weight: 0,01 kg
Code: S0646 B) female with bushing in to the side hood - 3 pin	Price:
	Weight: 0,01 kg

Connector for boilers with burner - into side hood

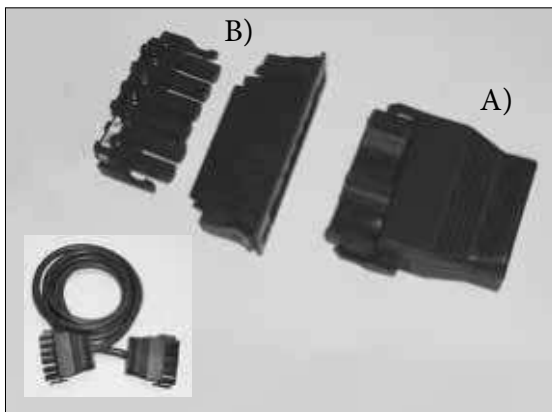

Code: S0985 A) male with lid - 6-pin connector	Price:
	Weight: 0,02 kg
Code: S0986 B) female with bushing - 6-pin connector	Price:
	Weight: 0,02 kg
Code: S0739 connecting cable between boiler and burner - 2,5 m - complete with connectors type S0985 and S0991	Price:
	Weight: 0,52 kg
Code: S0994 B) female with bushing - 6-pin connector for cable - for boilers without hole in side hood - (alternative for code: S0986)	Price:
	Weight: 0,02 kg
Code: S1262 connecting cable between boiler and burner - 0,6 m - complete with connectors type S0985 and S0991 - for DxxPX, PXxx	Price:
	Weight: 0,20 kg

Compressor connector for burner pneumatic cleaning

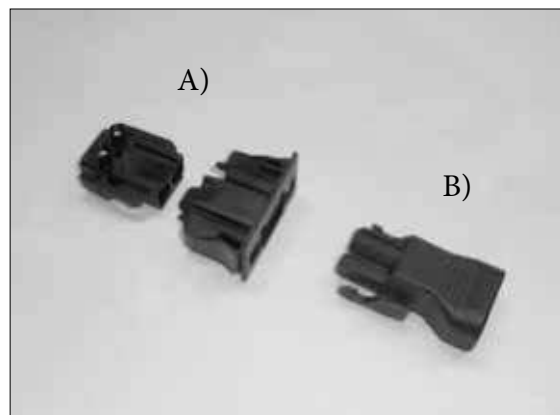

Code: S1092 A) male connector with bushing - in boiler side hood for connecting of pneu. cleaning compressor - 2 pin - pellet boilers D80P, P80	Price:
	Weight: 0,01 kg
Code: S1093 B) female connector for cable - 2 pin	Price:
	Weight: 0,01 kg

Connectors for conveyor - for boilers DxxPX, PXxx

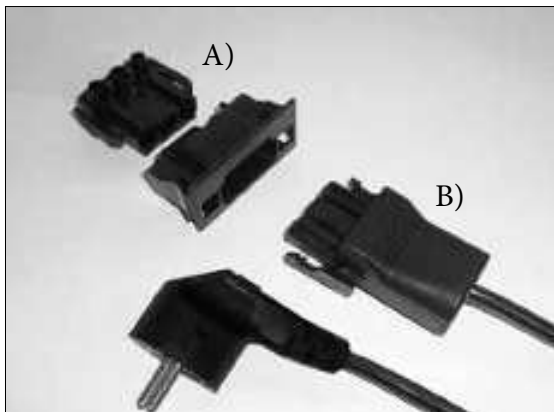

Code: S0641 A) male connector with bushing	<i>Price:</i>
	<i>Weight: 0,01 kg</i>
Code: S0640 B) female connector for cable	<i>Price:</i>
	<i>Weight: 0,01 kg</i>
Code: S1263 connecting cable between boiler and burner DxxPX, PXxx with connector type B) (S0640) for bushing A) (S0640)	<i>Price:</i>
	<i>Weight: 0,14 kg</i>

Old switch

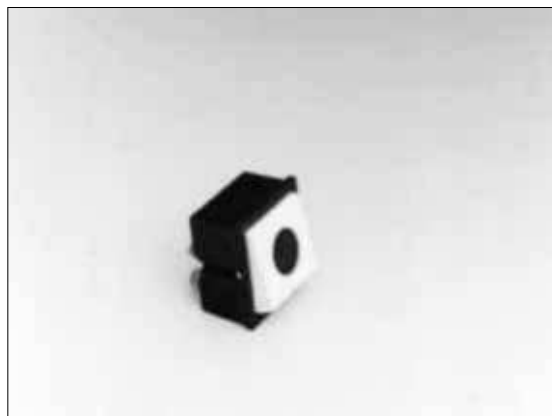

Code: S0081 old switch	<i>Price:</i>
	<i>Weight: 0,06 kg</i>
Code: S0082 fitting spring	<i>Price:</i>
	<i>Weight: 0,01 kg</i>

Cable with connector for the fan UCJ4Cxx



Code: S0132 cable with connector for the fan UCJ4Cxx - for connecting from side hood in to the terminal board (except D80P, P80)	<i>Price:</i>
	<i>Weight: 0,10 kg</i>

New switch



Code: S0091 main switch for boilers new version – green (I-O)	<i>Price:</i>
	<i>Weight: 0,04 kg</i>
Code: S0092 switch – red (I-O)	<i>Price:</i>
	<i>Weight: 0,04 kg</i>
Code: S0102 switch – black (I-O)	<i>Price:</i>
	<i>Weight: 0,04 kg</i>
Code: S0093 switch – orange (I-O)	<i>Price:</i>
	<i>Weight: 0,04 kg</i>
Code: S0096 changeover switch (I-O-II) DCxxSP(L), CxxSP(L), KCxxSP(L), DCxxGSP(L)	<i>Price:</i>
	<i>Weight: 0,04 kg</i>
Code: S0098 double switch (dual rocker) (I-O / I-O) black for pellet boilers DxxP, PXxx	<i>Price:</i>
	<i>Weight: 0,04 kg</i>
Code: S0099 double switch (dual rocker) (I-O-II) for boilers with automatic wood ignition (AIW) and regulator AC32	<i>Price:</i>
	<i>Weight: 0,04 kg</i>

Pocket and fuse for boilers

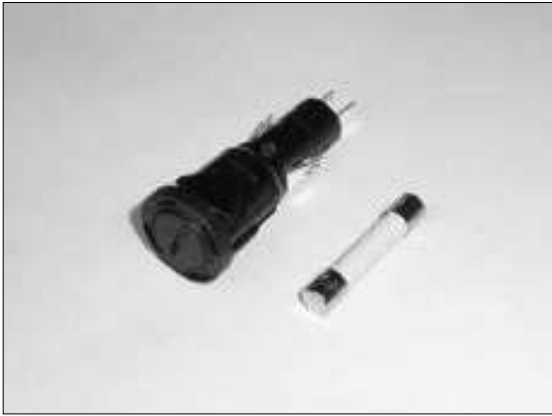

Code: S0184 pocket for fuse in the control panel of the pellet boilers DxxP, DCxxSP(L), DCxxGSP(L), CxxSP(L), AC/KCxxSP(L), DxxPX, Pxxx, boilers with in-built burner - model 2017 (AC03) boilers with control unit ACD01

Price:
Weight: 0,01 kg

Code: S0200 fuse T6,3A/1500-type H

Price:
Weight: 0,01 kg

Bearing for fan

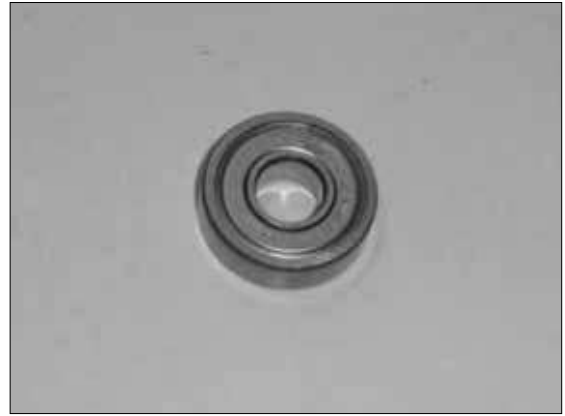

Code: S0142 spare bearing for exhaust fan UCJ4Cxx - not for ordinary user - can not be easily replaced

Price:
Weight: 0,02 kg

Capacitor of the extraction fan

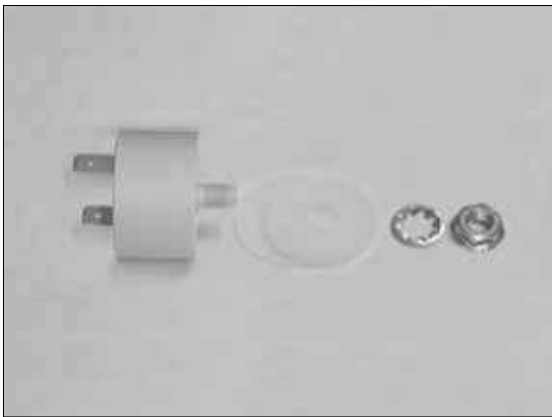

Code: S0171 for fan UCJ4C52 - 1 μ F

Price:
Weight: 0,06 kg

Code: S0173 for fan UCJ4C82 - 2 μ F

Price:
Weight: 0,06 kg

Code: S0175 for fan UCJ4C52A - 4 μ F – 120V

Price:
Weight: 0,06 kg

Capacitor for radial fans 3 μ F

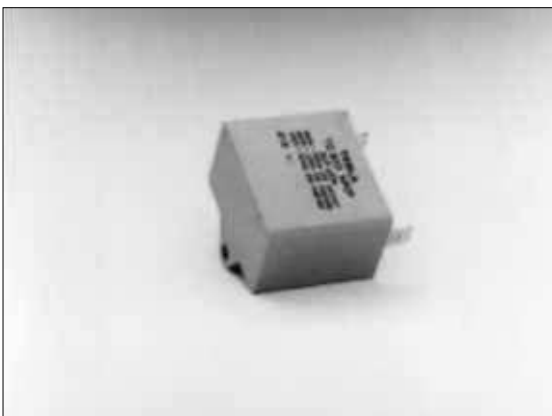

Code: S0101 for all radial blowing fans KORA

Price:
Weight: 0,06 kg

Fan – Mezaxial

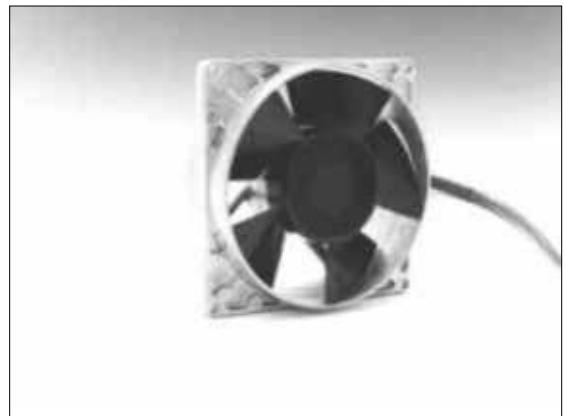

Code: S0111 for old types of boilers - fan without capacitor

Price:
Weight: 0,96 kg

Radial fan – Kora



NOTE: plastic grid S0271

Code: S0147 120/45 with reduction – replaces the radial fan Kora 120/35 and Ratas 3132 (S0121) – for boilers DC40G, DC50, C30, C40 old version	<i>Price:</i>
	<i>Weight: 2,90 kg</i>
Code: S0122 120/45 – for DC70S (DC80)	<i>Price:</i>
	<i>Weight: 2,16 kg</i>
Code: S0123 120/55 – for DC100	<i>Price:</i>
	<i>Weight: 2,22 kg</i>

Exhaust fan UCJ4C52 / UCJ4C52A-USA

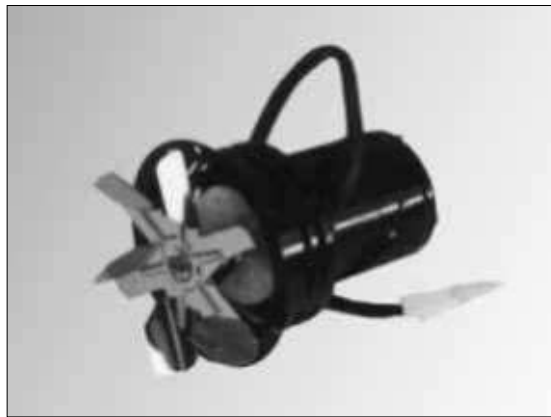

UCJ4C52 fan – delivered with capacitor 1µF

Code: S0131 detached motor 230V/50Hz - for DCxxS, CxxS, ACxxS, KCxxS, DCxxSP(X)(L), CxxSP(L), AC/KCxxSP(L), DCxxGSE, DCxxGD, DCxxSX, DxxP, Pxx, DCxxRS, DC50GSX, DC60GSX, GSX50, GSX60, DCxxGS, GSxx, DxxPX, PXXx	<i>Price:</i>
	<i>Weight: 2,64 kg</i>

120V/60Hz (USA) motor – delivered with capacitor 4µF

Code: S0135 detached motor for America 120V/60Hz – for DCxxS, CxxS, ACxxS, KCxxS, DCxxSP(L), CxxSP(L), AC/KCxxSP(L) DCxxGSE, DCxxGD, DCxxSX, DxxP, Pxx, DCxxRS, DC50GSX, DC60GSX, GSX50, GSX60, DCxxGS, GSxx	<i>Price:</i>
	<i>Weight: 4,00 kg</i>

- 230V/50Hz fan with capacitor, plate and gaskets

Code: S0133 motor with impeller Ø 150 mm, plate and gaskets	<i>Price:</i>
	<i>Weight: 3,98 kg</i>
Code: S0134 motor with impeller Ø 175 mm, plate and gaskets	<i>Price:</i>
	<i>Weight: 4,10 kg</i>
Code: S0139 motor with close impeller Ø 175 mm, plate and gaskets - (DC50SE, DC50S, DC50GSX, DC60GSX, DC50GSE, C40S, C50S)	<i>Price:</i>
	<i>Weight: 4,30 kg</i>

Exhaust fan UCJ4C82 / UCJ4C82B



UCJ4C82 fan is only for boilers DC75SE and DC70GSX (chamber 600 mm) – delivered with capacitor 2µF

Code: S0136 detached motor for DC75SE, DC70GSX (chamber 600 mm)	<i>Price:</i>
	<i>Weight: 3,28 kg</i>
Code: S0138 motor with impeller diameter Ø 200 mm and a plate	<i>Price:</i>
	<i>Weight: 5,42 kg</i>

UCJ4C82B fan with a speed sensor for boilers D80P, P80, D85P, P85 – delivered with capacitor 2µF

Code: S0148 detached motor for D80P, P80, D85P, P85	<i>Price:</i>
	<i>Weight: 3,36 kg</i>
Code: S0149 motor with impeller diameter Ø 200 mm and a plate	<i>Price:</i>
	<i>Weight: 5,50 kg</i>

Exhaust fan UCJ4C102 (J22RR552)



UCJ4C82 fan – delivered with capacitor 2µF

Code: S0150 motor with impeller Ø 200/65 and a plate - for boilers DC105S, DC150S, DC70GSX (chamber 800 mm)	<i>Price:</i>
	<i>Weight: 5,78 kg</i>
Code: S0153 detached motor for fan - for boilers DC105S, DC150, DC70GSX (chamber 800 mm)	<i>Price:</i>
	<i>Weight: 3,52 kg</i>

Impeller – small – Ø 150 mm - opened



Code: S0141 for boilers: DC18S, DC22S, DC25S, DC30SE, DC22SX, DC30SX, DC15GS, DC20GS, DC25GS, GS15, GS20, GS25, C15S, C18S, AC16S, AC25S, KC16S, KC25S, DC18GSE, DC22GSE, DC25GSE, DC18GD, DC25GD, D31P, P31, DxxPX, PXxx
 DC18SP(L), DC25SP(L), DC30SPX(L), DC18GSP(L), DC25GSP(L), C18SP(L), KC25SP(L)

<i>Price:</i>
<i>Weight:</i> 0,10 kg

Impeller Ø 175 mm, Ø 200 mm – closed

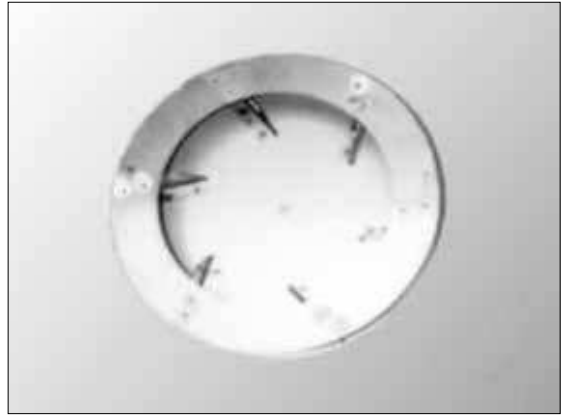

Code: S0154 closed impeller Ø 175 mm for boilers DC50SE, DC50S, C40S, C50S, DC50GSE, DC50GD, DC50GSX, DC60GSX, D50P (D45P), P50, AC45S, KC45S	<i>Price:</i>
	<i>Weight:</i> 0,38 kg

Code: S0190 closed impeller Ø 200/52 mm - fan UCJ4C82 / UCJ4C82B for - DC75SE, DC70GSX (chamber 600 mm), D80P, P80, D85P, P85	<i>Price:</i>
	<i>Weight:</i> 0,72 kg

Impeller – big - Ø 175 mm - opened



Code: S0151 for boilers ATMOS: DC32S, DC50S, DC40SX, DC32GS, DC40GS, GS32, GS40, C20S, C30S, C80S, AC35S, KC35S, DC24RS, DC30RS, DC30GSE, DC40GSE, DC30GD, DC40GD, D20P, D30P, D40P, D50P, P20, P30, P40, P50, DC32SP(L), DC30GSP(L), C25SP(L), KC32SP(L)

<i>Price:</i>
<i>Weight:</i> 0,18 kg

Impeller Ø 200/65 mm – closed

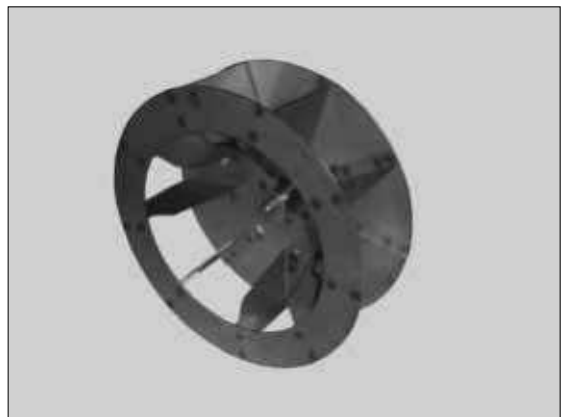

Code: S0166 closed impeller Ø 200/65 mm - for DC105S, DC150S DC70GSX (chamber 800 mm) fan UCJ4C102 (J22RR552)	<i>Price:</i>
	<i>Weight:</i> 0,82 kg

Small sealing of the exhaust fan

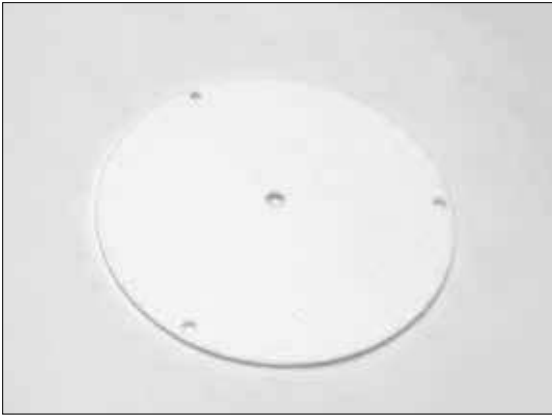

Code: S0161 between motor and a exhaust fan	Price:
	Weight: 0,02 kg

Board for exhaust fan



Code: S0959 board for both types of exhaust fan - type UCJ4C52	Price:
	Weight: 1,00 kg

Code: S0961 board for both types of exhaust fan - type UCJ4C82, UCJ4C102	Price:
	Weight: 1,10 kg

Big gasket of the exhaust fan - NEW



NEW VERSION - PROOFER VERSION

- it is enough 1 pieces for boiler when changing

Code: S1139 NEW gasket of the exhaust fan UCJ4C52 - from 1.3.2017 Sibral paper with vermikulit - thickness 4 mm	Price:
	Weight: 0,06 kg

Code: S1140 NEW gasket of the exhaust fan - from 1.3.2017 DC75SE, DC70GSX, D80P, P80, (fan UCJ4C82(B)) DC105S, DC150S - (fan UCJ4C102) Sibral paper with vermikulit - thickness 4 mm	Price:
	Weight: 0,06 kg

Wing nut



Code: S0776 wing nut M8 - for mounting the fan	Price:
	Weight: 0,01 kg

Small gasket of the air (regulating) flap

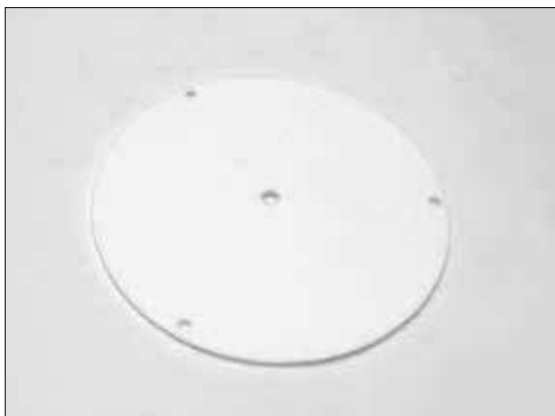

Code: S0161 gasket that sticks to air flap for pellet boilers, boilers with modification for burner and boilers SP(X)L

<i>Price:</i>
<i>Weight:</i> 0,02 kg

Lid (under regulating flap)

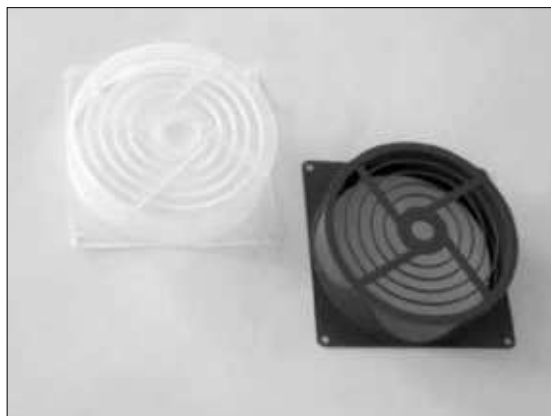

Code: S0271 for all ATMOS boilers except DC70S and DC100

<i>Price:</i>
<i>Weight:</i> 0,06 kg

Code: S0956 for all types of ATMOS with built-in burner in upper door of gasification boiler - metal

<i>Price:</i>
<i>Weight:</i> 0,32 kg

FR 124 Draught regulator



Code: S0011 for boiler 15kW - 80kW

<i>Price:</i>
<i>Weight:</i> 0,40 kg

Code: S0012 Spare thermal cartridge for FR 124

<i>Price:</i>
<i>Weight:</i> 0,04 kg

Closing mechanism - slide valve



For gasification boilers with an in-built burner in the upper doors and pneumatic burner cleaner

Code: H0535 for boilers: DC18S, DC22S, DC25S, DC30SX, C18S, C20S, C25ST, C30S, C32ST, C40S, AC25S, AC35S, KC25S, KC35S, DC30RS

<i>Price:</i>
<i>Weight:</i> 0,34 kg

Code: H0537 for boilers: DC30SE, DC32S, DC40SX, DC50S

<i>Price:</i>
<i>Weight:</i> 0,36 kg

Regulating flap

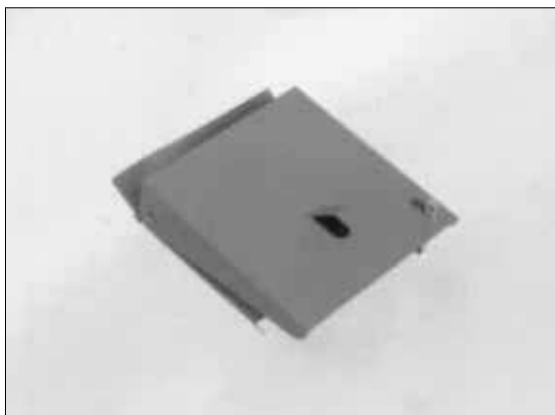

Code: S0281 for all types of ATMOS boilers – except DC100, DC50SE (new)

<i>Price:</i>
<i>Weight:</i> 0,32 kg

Code: S1141 with arm - for boilers DxxP a Pxx

<i>Price:</i>
<i>Weight:</i> 0,38 kg

Throttle branch - Ø 80 (70) mm under regulating flap



Code: S0287 for boilers DC18S, C15S, AC16S, KC16S, (C18S), DC15GS, GS15, DC20GS, GS20, DC18GD

<i>Price:</i>
<i>Weight:</i> 0,68 kg

**Regulating flap with actuator
GSE, GSX, GSP(L), SP(X)L**

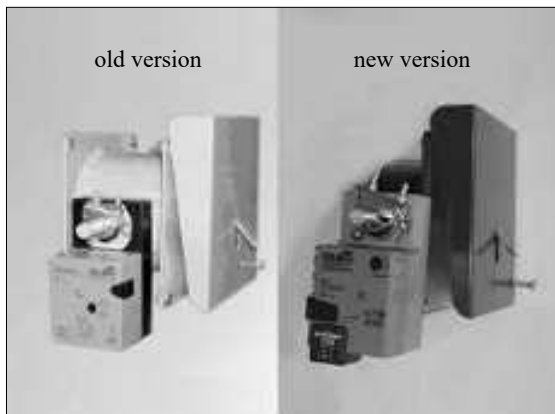

Code: P0086 Belimo actuator (except DCxxGSP(L))	<i>Price:</i>
	<i>Weight: 0,54 kg</i>
Code: P0072 Belimo actuator for boilers DCxxGSP(L) (LM230A-S-C10/200.1)	<i>Price:</i>
	<i>Weight: 0,55 kg</i>
Code: S0257 mechanical flap with shift - old type DC22GSE, DC25GSE, DC30GSE, DC40GSE, DC50GSE, DC50GSX, GSX50, DC60GSX, GSX60, DC70GSX, GSX70	<i>Price:</i>
	<i>Weight: 1,32 kg</i>
Code: S0268 mechanical flap with shift - new integrated design DC22GSE, DC25GSE, DC30GSE, DC40GSE, DC50GSE, DC50GSX, GSX50, DC60GSX, GSX60, DC70GSX, GSX70, DCxxGSP(L)	<i>Price:</i>
	<i>Weight: 1,08 kg</i>
Code: S1548 mechanical flap with shift - new integrated design DC70GSX-800, GSX70-800	<i>Price:</i>
	<i>Weight: 1,25 kg</i>
Code: S0294 mechanical flap with shift and silicone sealing - integrated performance - for boilers DC25GSP(L), DC30GSP(L), - from serial number 343500 - DC25SP(L), DC30SP(L), DC32SP(L), CxxSP(L), ACxxSP(L), KCxxSP(L)	<i>Price:</i>
	<i>Weight: 1,50 kg</i>
Code: S1264 mechanical flap with shift and silicone sealing - integrated performance - for boilers DC18GSP(L) - from serial number 343500 - DC18SP(L)	<i>Price:</i>
	<i>Weight: 1,08 kg</i>
Code: S0272 mechanical flap with shift - integrated performance for DC18GSE	<i>Price:</i>
	<i>Weight: 2,20 kg</i>

Silicone sealing for regulating flap - GSP(L), SP(L)

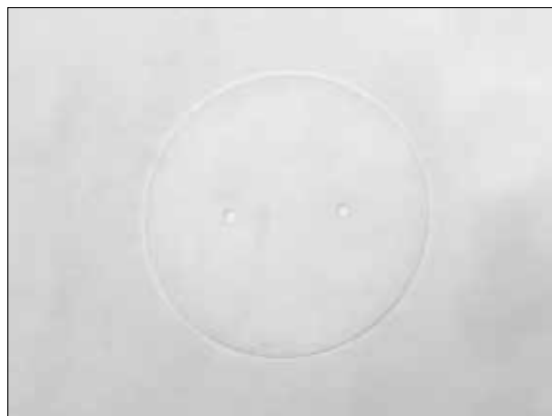

Code: S1050 silicone sealing for regulating flap controlled with actuator Belimo - for boilers DC25GSP(L), DC30GSP(L), DCxxSP((X)L), CxxSP(L), ACxxSP(L), KCxxSP(L)	<i>Price:</i>
	<i>Weight: 0,01 kg</i>
Code: S1236 silicone sealing for regulating flap controlled with actuator Belimo - for boilers DC18GSP(L)	<i>Price:</i>
	<i>Weight: 0,01 kg</i>

Belimo actuator with spring - DC105S, DC150S



Code: P0083 Belimo actuator with spring for DC105S, DC150S	<i>Price:</i>
	<i>Weight: 1,72 kg</i>

Servocontrolled flap with spring – for DC50SE



Code: P0085 for DC50SE – replaces draught regulator FR124 with flap - complete	<i>Price:</i>
	<i>Weight: 4,08 kg</i>
Code: P0083 servomotor Belimo with spring – detached	<i>Price:</i>
	<i>Weight: 1,72 kg</i>
Code: S0256 detached mechanical flap	<i>Price:</i>
	<i>Weight: 2,30 kg</i>

Hinges complete and accessories

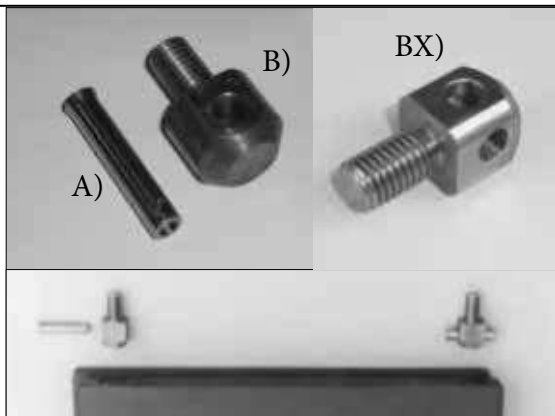

Code: S0221 2x bolt a 2x pin - set	<i>Price:</i>
	<i>Weight:</i> 0,20 kg
Code: S0222 A) 1x separate pin kolík Ø 8x40 (8x43)	<i>Price:</i>
	<i>Weight:</i> 0,02 kg
Code: S0223 B) 1x separate hinges bolt	<i>Price:</i>
	<i>Weight:</i> 0,08 kg
Code: S1109 BX) 1x separate hinges bolt eccentric - service version	<i>Price:</i>
	<i>Weight:</i> 0,08 kg
Code: S1381 SERVICE KIT 2x S1109 + 2x S0222	<i>Price:</i>
	<i>Weight:</i> 0,20 kg

Small door complete - without frame



Complete with handle and sleeve, with two hinges and two pins - without sealing cord and Sibral insulation

Code: S0201 upper right	<i>Price:</i>
	<i>Weight:</i> 12,44 kg
Code: S0202 upper left	<i>Price:</i>
	<i>Weight:</i> 12,44 kg
Code: S0203 lower right	<i>Price:</i>
	<i>Weight:</i> 12,44 kg
Code: S0204 lower left	<i>Price:</i>
	<i>Weight:</i> 12,44 kg
Code: S1491 upper right - with lock screw for boilers with ignition, D80P	<i>Price:</i>
	<i>Weight:</i> 12,50 kg
Code: S1492 upper left - with lock screw for boilers with ignition	<i>Price:</i>
	<i>Weight:</i> 12,50 kg

Large door complete (without frame)



Upper door - DC100, D14P, D21P, D31P, P14, P21, P25, P31, DCxxGSX, GSXxx, D21, DC75SE – new version

Upper door + Bottom door - DC105S, DC150S,

Code: S0461 upper right	<i>Price:</i>
	<i>Weight:</i> 14,24 kg
Code: S0460 upper left	<i>Price:</i>
	<i>Weight:</i> 14,24 kg
Code: S1143 bottom right DC105S, DC150S	<i>Price:</i>
	<i>Weight:</i> 14,24 kg
Code: S1142 bottom left DC105S, DC150S	<i>Price:</i>
	<i>Weight:</i> 14,24 kg
Code: S1207 upper right - boilers with front cover (doors) - nut closure D14P, D21P, D25P, D31P, P14, P21, P25, P31, D85P, P85	<i>Price:</i>
	<i>Weight:</i> 14,24 kg

Big door complete (without frame) with hole for pellet burner, LFO or natural gas



Code: S0458 big - lower left ACxxSP(L), KCxxSP(L), CxxSP(L), DCxxSP(L), EP(L), DCxxGSP(L)	<i>Price:</i>
	<i>Weight:</i> 14,38 kg
Code: S0459 big - lower right ACxxSP(L), KCxxSP(L), CxxSP(L), DCxxSP(L), EP(L), DCxxGSP(L), DxxPX, PXxx	<i>Price:</i>
	<i>Weight:</i> 14,38 kg
Code: S0417 small – upper left for burner A25	<i>Price:</i>
	<i>Weight:</i> 11,30 kg
Code: S0416 small – upper right for burner A25	<i>Price:</i>
	<i>Weight:</i> 11,30 kg
Code: S0419 small – upper left for burner A45	<i>Price:</i>
	<i>Weight:</i> 11,92 kg
Code: S0420 small – upper right for burner A45	<i>Price:</i>
	<i>Weight:</i> 11,92 kg

Sealing cord 14x14 – for old door version



Code: S0231 sealing cord for old type of complete door with cast iron frame	<i>Price:</i>
	<i>Weight: 0,22 kg</i>

Sealing cord 18x18 – for new door version



Code: S0241 for small door complete without frame	<i>Price:</i>
	<i>Weight: 0,40 kg</i>
Code: S0240 for big door complete with cast iron frame	<i>Price:</i>
	<i>Weight: 0,40 kg</i>

Cleaning door closure for pellet boilers



Code: S1088 complete closure of cleaning door for pellet boilers	<i>Price:</i>
	<i>Weight: 0,32 kg</i>

Assembled closure (wheel, cam, lenticular, crank, handle, pin, 2xM12)

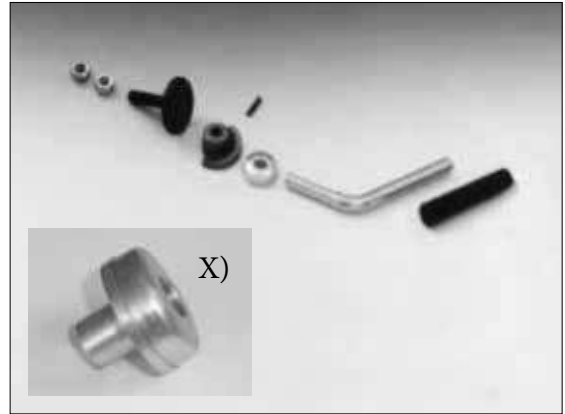

Code: S0211 left-hand type - complete - not driller	<i>Price:</i>
	<i>Weight: 0,58 kg</i>
Code: S0212 right-hand type (default type) - complete - not driller	<i>Price:</i>
	<i>Weight: 0,58 kg</i>
Code: C0020 cam - eccentric - right	<i>Price:</i>
	<i>Weight: 0,14 kg</i>
Code: C0025 cam - eccentric - left	<i>Price:</i>
	<i>Weight: 0,14 kg</i>
Code: S0225 crank – separate	<i>Price:</i>
	<i>Weight: 0,21 kg</i>
Code: S0213 handle sleeve	<i>Price:</i>
	<i>Weight: 0,22 kg</i>
Code: S0218 pin Ø 4x25	<i>Price:</i>
	<i>Weight: 0,01 kg</i>
Code: S0220 wheel	<i>Price:</i>
	<i>Weight: 0,14 kg</i>
Code: S0169 closure lenticular	<i>Price:</i>
	<i>Weight: 0,08 kg</i>
Code: S1108 X) closure lenticular with bushing - servise version (new bushing)	<i>Price:</i>
	<i>Weight: 0,08 kg</i>

Closure for boilers SP(L), GSP(L), DxxPX, PXxx, D14P, D21P, D25P, P14, P21, P25 - with front cover



Code: S1047 complete closure for right big door DCxxSP(L), CxxSP(L) DCxxGSP(L), ACxxSP(L), KCxxSP(L), DxxPX, PXxx, D80P, P80, D85P, P85 D14P, D21P, D25P, P14, P21, P25 - with front cover	<i>Price:</i>
	<i>Weight: 0,60 kg</i>
Code: S1046 complete closure for left big door DCxxSP(L), CxxSP(L) DCxxGSP(L), ACxxSP(L), KCxxSP(L)	<i>Price:</i>
	<i>Weight: 0,60 kg</i>

Sibral – door insulation – big - thick

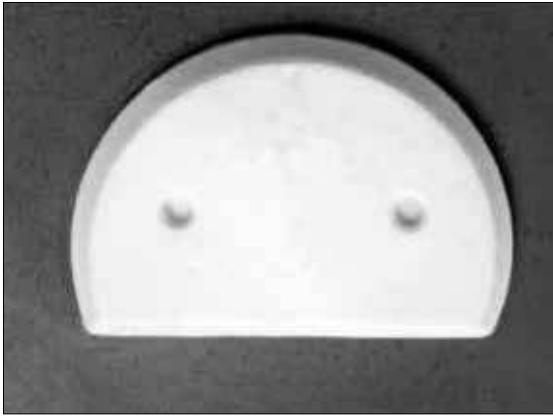

Code: S0264 sibral for upper door without hole – DC100, DC105S, DC150S , DC75SE, DCxxGSX, GSXxx, D14P - D31P, P14 - P31, D85P, P85, D21 - thickness 42 mm - with screws M6x45 (S0728) + 2x washers (S0782)	<i>Price:</i>
	<i>Weight:</i> 1,66 kg

Code: S0263 detached sibral for upper door without hole - DC100, DC105S, DC150S DC75SE, DCxxGSX, GSXxx, D14P - D31P, P14 - P31, D85P, P85, D21 - thickness 42 mm	<i>Price:</i>
	<i>Weight:</i> 1,65 kg

Code: S1185 sibral for bottom door without hole – DC105S, DC150S - thickness 42 mm - with screws M6x80 (S0729) + 2x washers (S0782)	<i>Price:</i>
	<i>Weight:</i> 1,67 kg

Sibral door insulation – thick with hole for pellet burner

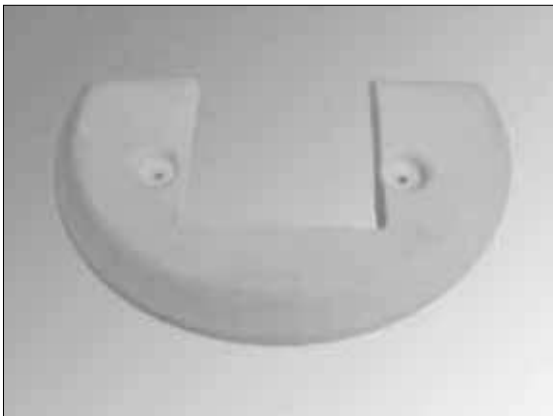

Code: S0266 big – into big lower door of the boiler DCxxSP(X), EP, CxxSP, ACxxSP, KCxxSP, DCxxGSP, DxxPX, PXXx	<i>Price:</i>
	<i>Weight:</i> 1,32 kg

Code: S0517 small – into small upper doors of the gasification boiler with modification for pellet burner - burner A25	<i>Price:</i>
	<i>Weight:</i> 0,90 kg

Code: S1087 (2 pcs - halfmoon) into small upper doors of the gasification boiler with modification for pellet burner - burner A45	<i>Price:</i>
	<i>Weight:</i> 0,60 kg

Code: S0938 stainless screen into small upper doors of the gasification boiler with modification for pellet burner - burner A45	<i>Price:</i>
	<i>Weight:</i> 0,56 kg

Sibral – door insulation – small - thick

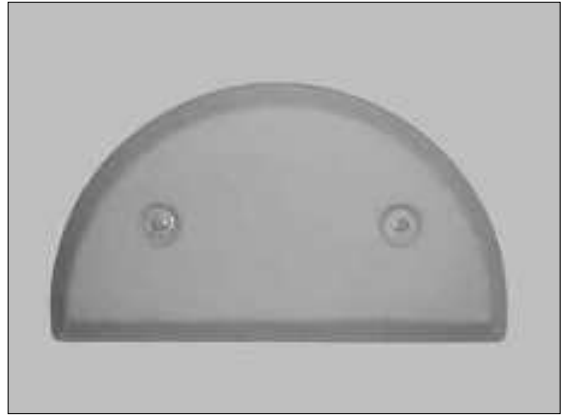

Code: S0261 thickness 42 mm – with screws 2x M6x45 (S0728) + 2x washers (S0782)	<i>Price:</i>
	<i>Weight:</i> 1,48 kg

Code: S0262 detached sibral thickness 42 mm	<i>Price:</i>
	<i>Weight:</i> 1,38 kg

Sibral – door insulation – small - thin



Code: S0251 thickness 32mm – sibral delivered include screws M6x65 + 2 washers - for boilers with spherical chamber and door shield (halfmoon - DC0021)	<i>Price:</i>
	<i>Weight:</i> 1,10 kg

Code: S1147 thickness 32 mm - with screws 2x M6x35 (S0721) + 2x washers (S0782) - for upper door for boilers CxxS/ST, D15P, D20P, D30P, D40P, D50P (D45P), P15 - P50	<i>Price:</i>
	<i>Weight:</i> 1,09 kg

Code: S0252 detached sibral - thickness 32 mm	<i>Price:</i>
	<i>Weight:</i> 1,08 kg

Sibral door insulation - big - thick DCxxSPL (EPL), CxxSPL, ACxxSPL, KCxxSPL, DCxxGSPL

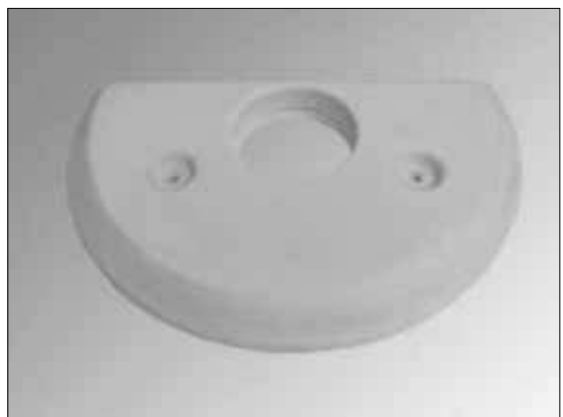

Code: S0265 with hole prepared for LFO or natural gas burner	<i>Price:</i>
	<i>Weight:</i> 1,54 kg

Plate for fitting burner for natural gas or LFO

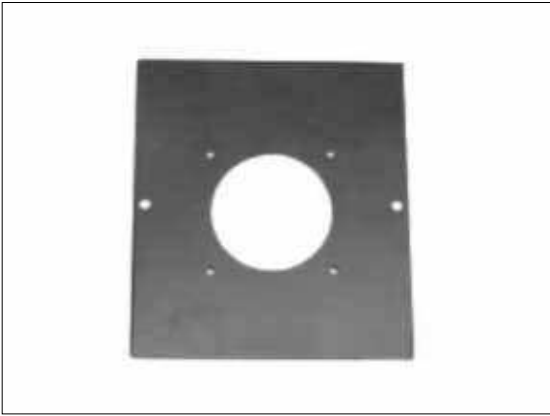

Code: S0457 for DC15EPL, CxxSPL, AC/KCxxSPL, DCxxSPL, DCxxGSPL
Price:
Weight: 1,40 kg

Blind flange for blinding the hole after burner

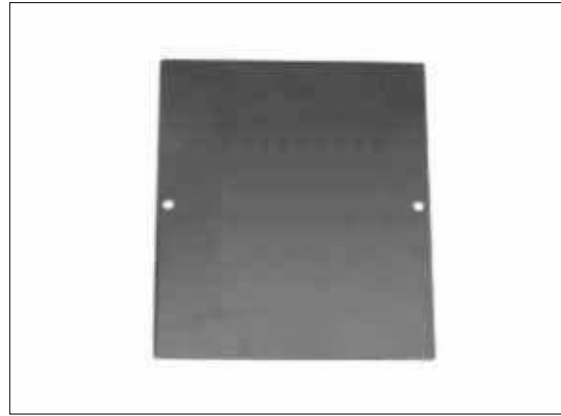

Code: S0491 for DC15EPL, CxxSPL, AC/KCxxSPL, DCxxSPL, DCxxGSPL
Price:
Weight: 0,70 kg

Insulation under a plate for fitting the natural gas or LFO burner to the boiler



Code: S0253 soft sibral
Price:
Weight: 0,25 kg

Sibral burning chamber for heating with oil in boilers DxxP

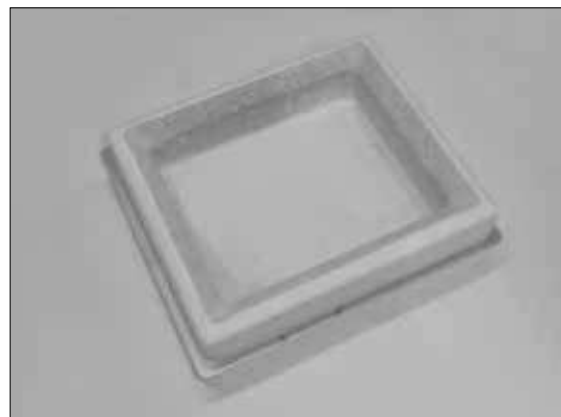

Code: S0291 sibral cube with stainless steel frame - set
Price:
Weight: 0,36 kg

Insulation under pellet burner for SP (EP), GSP, PX and for boilers with burner in upper doors

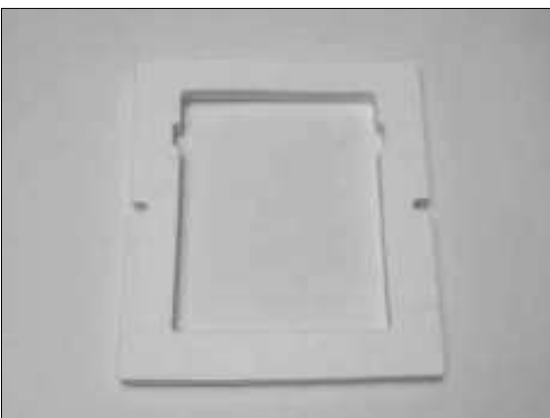

Code: S0164 insulation between burner and boiler – sibral – for SP(EP), GSP, DxxPX, Pxxx and for old model gasification boilers with burners of pellet A25 in upper doors
Price:
Weight: 0,18 kg

Code: S0140 insulation between burner and boiler – sibral – for gasification boilers with burners of pellet A45 in upper doors
Price:
Weight: 0,10 kg

Tube exchanger cleaning doors for pellet boilers D15P - D80P, P15 - P80



Code: S1104 tube exchanger doors for boilers D15P - D50P, P15 - P50
Price:
Weight: 8,33 kg

Code: S1112 sealing cord for cleaning doors - boilers D15P - D50P, P15 - P50
Price:
Weight: 0,36 kg

Code: S1105 tube exchanger doors for boilers D80P, P80
Price:
Weight: 9,65 kg

Code: S1113 sealing cord for cleaning doors - boilers D80P, P80
Price:
Weight: 0,42 kg

Sealing cord for burner into the frame DxxP, Pxx

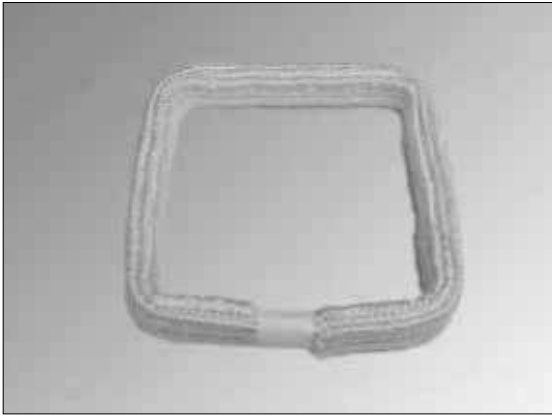

Code: S0165 sealing cord 18x32 - into the boiler frame - D15P, D20P, P15, P20, D14-25P, P14-25	<i>Price:</i>
	<i>Weight: 0,38 kg</i>
Code: S0174 sealing cord 18 x 32 - into the boiler frame - D30P, D40P, D50P, P30, P40, P50, D31P, P31	<i>Price:</i>
	<i>Weight: 0,42 kg</i>
Code: S0152 ealing cord 18 x 32 - into the boiler frame - D80P, P80, D85P, P85	<i>Price:</i>
	<i>Weight: 0,54 kg</i>
Code: S0177 sealing cord 16 x 16 into upper door for gasification boilers with change for pellets burner	<i>Price:</i>
	<i>Weight: 0,24 kg</i>

Blinding lid for boilers with burner in upper door when burning wood



Code: S0525 complet lid for blinding the hole after burner A25	<i>Price:</i>
	<i>Weight: 3,10 kg</i>
Code: S0278 sibral block for small door and burner A25	<i>Price:</i>
	<i>Weight: 0,76 kg</i>
Code: S0518 blinding - cover plate thickness 4 mm - burner A25	<i>Price:</i>
	<i>Weight: 1,64 kg</i>
Code: S0496 cover plate thickness 1 mm - burner A25	<i>Price:</i>
	<i>Weight: 0,45 kg</i>
Code: S0526 complet lid for blinding the hole after burner A45	<i>Price:</i>
	<i>Weight: 4,30 kg</i>
Code: S0290 sibral block for small door and burner A45	<i>Price:</i>
	<i>Weight: 1,30 kg</i>
Code: S0543 blinding - cover plate thickness 5 mm - burner A45	<i>Price:</i>
	<i>Weight: 3,90 kg</i>
Code: S0499 cover plate thickness 1 mm - burner A45	<i>Price:</i>
	<i>Weight: 0,99 kg</i>
Code: S0727 screw M6 x 70 with large washer for fixing insulation block	<i>Price:</i>
	<i>Weight: 0,05 kg</i>

Boční víko - nové

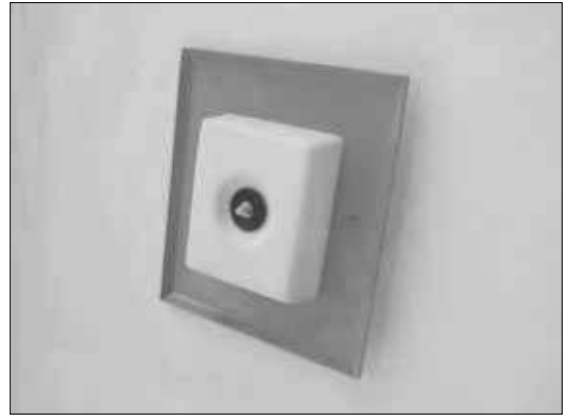

Code: S0503 side lid - new model - when burning wood - with sibral block - for D14P - D25P, P14 - P25, D15P, D20P, P15, P20 from serial number 120000	<i>Price:</i>
	<i>Weight: 4,30 kg</i>
Code: S0504 side lid - new model - when burning wood - with sibral block - for D30P, D40P, D50P, P30, P40, P50, D31P, P31	<i>Price:</i>
	<i>Weight: 4,84 kg</i>
Code: S0465 side lid for boiler D80P, P80 (lid - S0534, cube - S0293)	<i>Price:</i>
	<i>Weight: 5,32 kg</i>
Code: S1429 side lid for boiler for D85P, P85 (lid - S1428, cube - S0293, stainless steel shield - S1596)	<i>Price:</i>
	<i>Weight: 12,80 kg</i>
Code: S0275 sibral block for D14P, D21P, D25P, P14, P21, P25, D15P, D20P, P15, P20	<i>Price:</i>
	<i>Weight: 0,78 kg</i>
Code: S0277 sibral block for D30P, D40P, D50P, D31P, P31	<i>Price:</i>
	<i>Weight: 1,16 kg</i>
Code: S0293 sibral block for D80P, P80, D85P, P85	<i>Price:</i>
	<i>Weight: 2,75 kg</i>



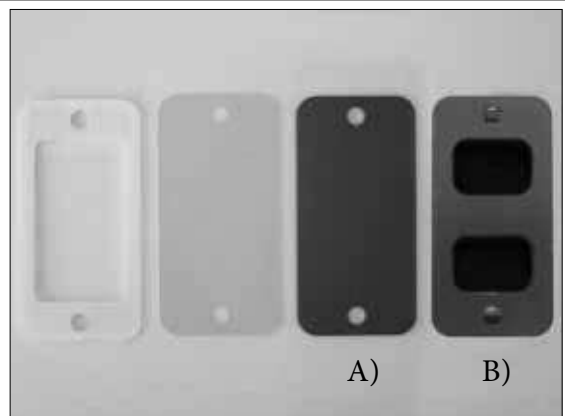



Insulation under cleaning lid D14 - 31P and P14 - 31



Code: S0120 sibral gasket with hole	<i>Price:</i>
	<i>Weight: 0,01 kg</i>
Code: S0124 klingerit gasket without hole	<i>Price:</i>
	<i>Weight: 0,01 kg</i>
Code: S0292 A - cover lid for cleaning hole	<i>Price:</i>
	<i>Weight: 0,05 kg</i>
Code: S1573 B - cover lid for cleaning hole for boilers with thick insulation of flue duct.	<i>Price:</i>
	<i>Weight: 0,46 kg</i>

Lids + sealing cords



Code: S0284 small – dimension: 105x260 	<i>Price:</i>
	<i>Weight:</i> 1,66 kg
Code: S0285 middle – dimension: 105x295 	<i>Price:</i>
	<i>Weight:</i> 1,98 kg
Code: S0286 big – dimension: 105x360 DC100 (rear-upper) 	<i>Price:</i>
	<i>Weight:</i> 2,10 kg
Code: S0301 DC18_22_25_30GSE (GD), GSP(L) - dimension 340x112 	<i>Price:</i>
	<i>Weight:</i> 3,54 kg
Code: S0302 DC40_50GSE (GD) - dimension 395x205 	<i>Price:</i>
	<i>Weight:</i> 2,06 kg
Code: S0507 DCxxGSX, GSXxx, DC30RS - dimension 185x345 	<i>Price:</i>
	<i>Weight:</i> 3,10 kg
Code: S0300 C50S - dimension 320x205 	<i>Price:</i>
	<i>Weight:</i> 3,22 kg
Sealing cord for:	
Code: S0242 for small lid - (12x12)	<i>Price:</i>
	<i>Weight:</i> 0,08 kg
Code: S0243 for middle lid - (12x12)	<i>Price:</i>
	<i>Weight:</i> 0,09 kg
Code: S0244 for big lid - (12x12)	<i>Price:</i>
	<i>Weight:</i> 0,10 kg
Code: S0303 for lid 340x112 GSP(L), DC18_22_25_30GSE (GD) - (12x14)	<i>Price:</i>
	<i>Weight:</i> 0,10 kg
Code: S0304 for lid 395x205 DC40_50GSE (GD) (12x14)	<i>Price:</i>
	<i>Weight:</i> 0,10 kg
Code: S0317 for lid 185x345 DCxxGSX, GSXxx, DC30RS – (18x18)	<i>Price:</i>
	<i>Weight:</i> 0,26 kg
Code: S0267 for lid 320x205 – C50S – (12x14)	<i>Price:</i>
	<i>Weight:</i> 0,12 kg

Insulation of lid for DC100



Code: S0145 insulation of lid (S0286) on the flue gas duct - sibral - DC100	<i>Price:</i>
	<i>Weight:</i> 0,10 kg

Lid for DxxP a D30



Code: S0955 lid for the three-tube heat exchanger - D15P - D50P, P15 - P50	<i>Price:</i>
	<i>Weight:</i> 6,26 kg
Code: S0960 sealing cord for lid of heat exchanger - D15P - D50P, P15 - P50	<i>Price:</i>
	<i>Weight:</i> 0,22 kg
Code: S0498 lid D30 - metal with sact iron ring and sealing cord	<i>Price:</i>
	<i>Weight:</i> 4,24 kg

Tube exchanger lid for DC100 - front



Code: S0403 tube exchanger lid for DC100 - front - without sealing cord	<i>Price:</i>
	<i>Weight:</i> 2,76 kg
Code: S0319 sealing cord for tube exchanger lid - DC100 - 12 x 12 x 940	<i>Price:</i>
	<i>Weight:</i> 0,12 kg

Tube exchanger lid for DC105S, DC150S - front

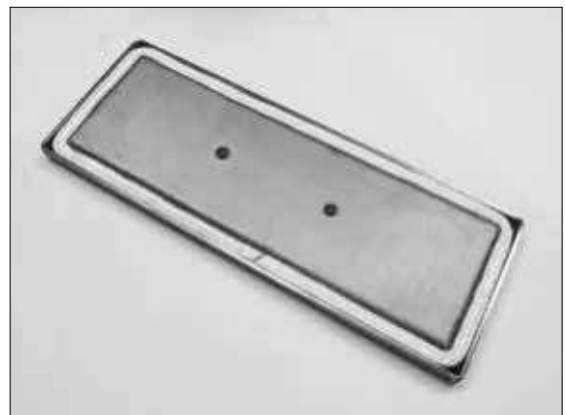

Code: S1148 tube exchanger lid for DC105S, DC150S - front - without sealing cord	<i>Price:</i>
	<i>Weight:</i> 3,99 kg
Code: S1149 sealing cord for tube exchanger lid - DC105S, DC150S - 12 x 12	<i>Price:</i>
	<i>Weight:</i> 0,20 kg

Lid and insulation for cleaning hole D80P, P80

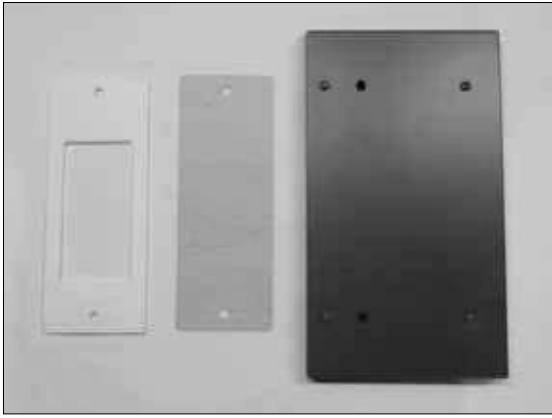

Code: S1089 cleaning lid for waste gas duct - D80P, P80 (R + L)	<i>Price:</i>
	<i>Weight:</i> 1,60 kg
Code: S1056 sibril gasket with hole	<i>Price:</i>
	<i>Weight:</i> 0,01 kg
Code: S1055 klingerit gasket without hole	<i>Price:</i>
	<i>Weight:</i> 0,01 kg

Cover for tube heat exchanger lid - DxxPX, PXxx

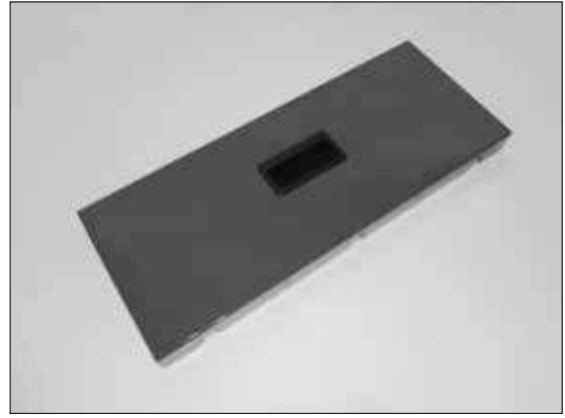

Code: S1401 cover for tube heat exchanger lid D10PX, PX10 - complete with insulation and handle (S1079)	<i>Price:</i>
	<i>Weight:</i> 1,25 kg
Code: S1292 cover for tube heat exchanger lid D15PX, D20PX, D25PX, PX15, PX20, PX25 - complete with insulation and handle (S1079)	<i>Price:</i>
	<i>Weight:</i> 1,37 kg

Lid for cleaning hole DC105S, DC150S - side

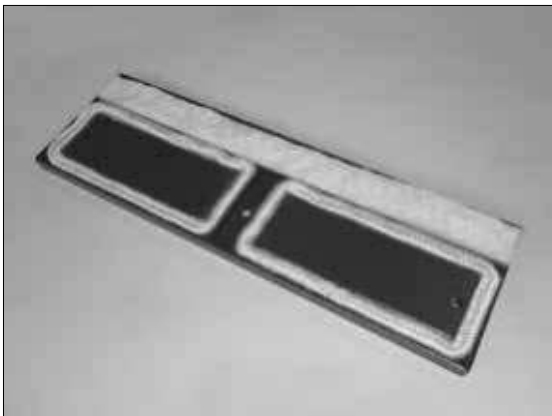

Code: S1186 complete lid for cleaning hole - side - sealing, insulation and hood	<i>Price:</i>
	<i>Weight:</i> 6,73 kg
Code: S1187 set of sealing cords for cleaning hole lid (2 pcs) - 14x14x650	<i>Price:</i>
	<i>Weight:</i> 0,10 kg

Pellet tank cover for DxxPX, PXxx

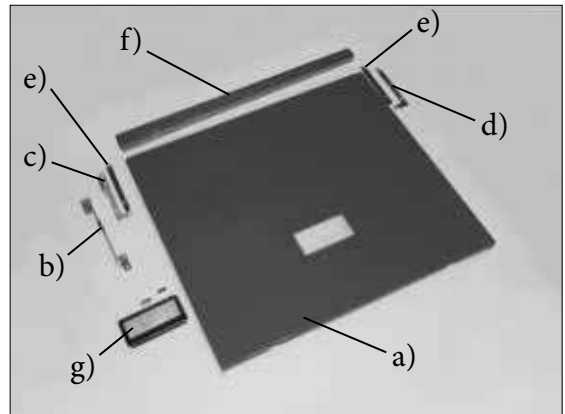

Code: H0301 a) pellet tank cover for D15PX, D20PX, D25PX, PX15, PX20, PX25	<i>Price:</i>
	<i>Weight:</i> 3,31 kg
Code: H0320 a) pellet tank cover for D10PX, PX10	<i>Price:</i>
	<i>Weight:</i> 1,80 kg
Code: S1134 b) cover prop - mechanical stop	<i>Price:</i>
	<i>Weight:</i> 0,15 kg
Code: S1293 c) cover holder - hinge - left for cover prop	<i>Price:</i>
	<i>Weight:</i> 0,05 kg
Code: S1294 d) cover holder - hinge - right	<i>Price:</i>
	<i>Weight:</i> 0,03 kg
Code: S1295 e) pad under the cover holder (under hinge)	<i>Price:</i>
	<i>Weight:</i> 0,02 kg
Code: S1358 f) hood for cover holders (hinge) D10PX, PX10	<i>Price:</i>
	<i>Weight:</i> 0,27 kg
Code: S1296 f) hood for cover holders (hinge) D15PX, D20PX, PX15, PX20	<i>Price:</i>
	<i>Weight:</i> 0,29 kg
Code: S1359 f) hood for cover holders (hinge) D25PX, PX25	<i>Price:</i>
	<i>Weight:</i> 0,29 kg
Code: S1079 g) handle for pellet tank cover	<i>Price:</i>
	<i>Weight:</i> 0,04 kg

Tube heat exchanger lid for DxxPX, PXxx

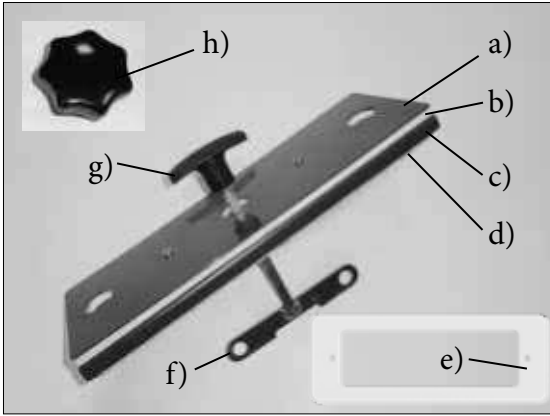

Code: S1297 a) cover for lid insulation	<i>Price:</i>
	<i>Weight:</i> 0,74 kg
Code: S1213 b) upper lid insulation	<i>Price:</i>
	<i>Weight:</i> 0,10 kg
Code: S1298 c) lid - alone	<i>Price:</i>
	<i>Weight:</i> 2,21 kg
Code: S1299 d) sealing cord for tube heat exchanger lid	<i>Price:</i>
	<i>Weight:</i> 0,11 kg
Code: S1214 e) gasket under the sealing cord of the lid	<i>Price:</i>
	<i>Weight:</i> 0,02 kg
Code: V0926 f) rod for flue way air-break	<i>Price:</i>
	<i>Weight:</i> 0,21 kg
Code: S0279 g) handle for rod	<i>Price:</i>
	<i>Weight:</i> 0,06 kg
Code: S0411 h) plastic nut M8	<i>Price:</i>
	<i>Weight:</i> 0,06 kg

Firing up flap - complete



Code: S0229 milled flap (landing surface), shoulder, pin, screw, shaft (hook) – with shaft (hook) - 236 mm	<i>Price:</i>
	<i>Weight:</i> 1,64 kg
Code: S1176 milled flap (landing surface), shoulder, pin, screw, shaft (hook) - DCxxGSX, GSXxx – with longer shaft (hook) - 271 mm	<i>Price:</i>
	<i>Weight:</i> 1,69 kg
Code: S0232 milled flap (landing surface), shoulder, pin, screw, shaft – DC100, DC105S, DC150S – with longer shaft (hook) - 284 mm	<i>Price:</i>
	<i>Weight:</i> 1,70 kg

Firing up rod

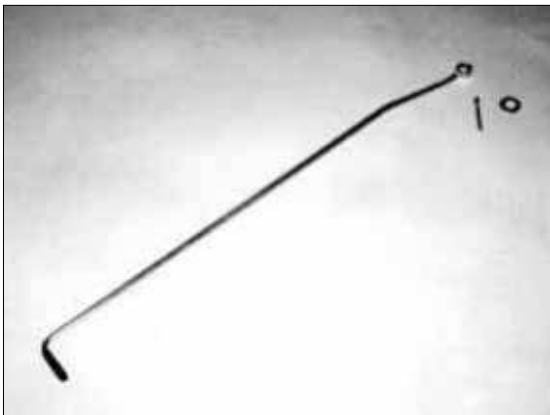
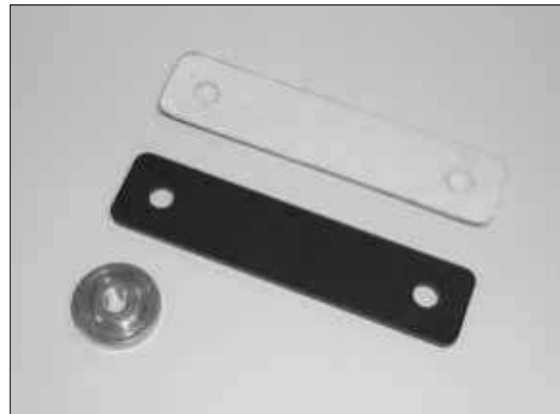

Table No. 2 on page 33

Code: S0188 rubber sleeve for pull rod	<i>Price:</i>
	<i>Weight:</i> 0,01 kg
Code: S0784 washer	<i>Price:</i>
	<i>Weight:</i> 0,01 kg
Code: S0761 split pin	<i>Price:</i>
	<i>Weight:</i> 0,01 kg

Lid and gasket for D15 - 50P, P15 - 50



Code: S0129 gasket - Sibal	<i>Price:</i>
	<i>Weight:</i> 0,01 kg
Code: S1305 lid - secondary air cover for D15 - 50P, P15 - 50	<i>Price:</i>
	<i>Weight:</i> 0,09 kg
Code: S0824 grooved metal nut M8	<i>Price:</i>
	<i>Weight:</i> 0,04 kg

Firing flap with a rod – air-break D30

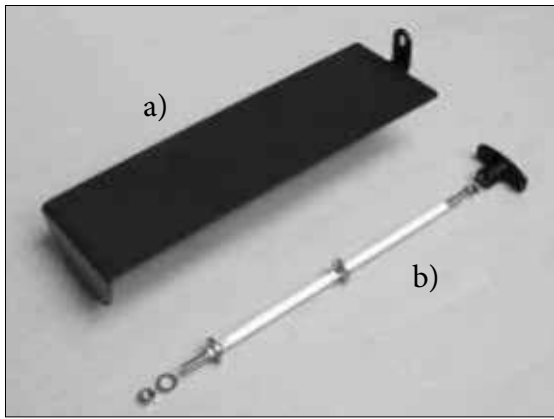

Code: S0428 a) firing up flap without rod – air break	<i>Price:</i>
	<i>Weight:</i> 2,70 kg
Code: V0512 b) rod	<i>Price:</i>
	<i>Weight:</i> 0,25 kg

Handels

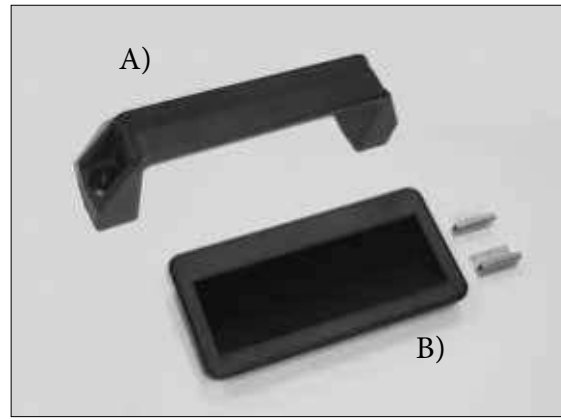

Code: S0230 A) handle for pellet tanks and ash trays	<i>Price:</i>
	<i>Weight:</i> 0,04 kg
Code: S1079 B) handle for pneumatic feeding system APS, boilers DxxPX, Pxxx, for front cover of pellet boilers D14-25P, P14-25	<i>Price:</i>
	<i>Weight:</i> 0,04 kg

Handle M10



Code: S0279 for the rod of the cleaning grate D15P, D20P, D30P, D40P, D50P (D45P), D15, D20, D21 and for firing up flap for D30 for flue way air-break rod for boilers DxxPX, Pxxx	<i>Price:</i>
	<i>Weight:</i> 0,06 kg

Choke valve into flue way Ø 152 mm

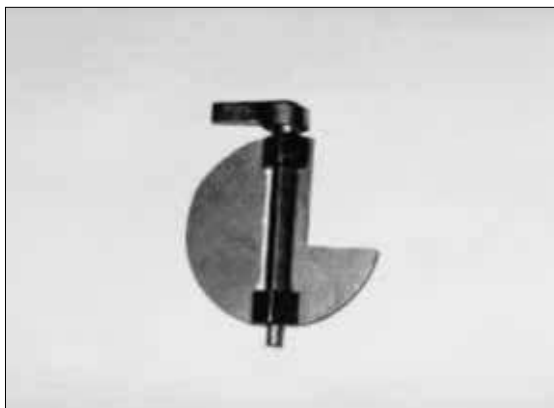

Code: S0226 composed of a shaft and a valve. For boilers D15, D20. Can be used to reduce chimney draft in boilers. DC18S - DC50SE, C18S - C40S, DCxxGSE, DCxxGD, DC22SX - DC40SX, ACxxS, D30, D21, DCxxRS, DCxxGSX	<i>Price:</i>
	<i>Weight:</i> 0,96 kg

Nuts



Code: S0776 wing nut M8	<i>Price:</i>
	<i>Weight:</i> 0,01 kg
Code: S0824 grooved metal nut M8	<i>Price:</i>
	<i>Weight:</i> 0,04 kg
Code: S0411 plastic nut M8	<i>Price:</i>
	<i>Weight:</i> 0,06 kg
Code: S0413 plastic nut M10	<i>Price:</i>
	<i>Weight:</i> 0,23 kg
Code: S0412 plastic nut M12	<i>Price:</i>
	<i>Weight:</i> 0,22 kg

Plastic cover – round

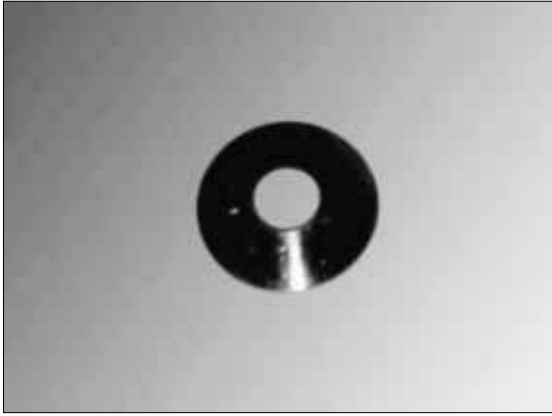

Code: S0187 for all boiler with cooling loop

Price:

Weight: 0,04 kg

Dash board – with holes for cooling loop

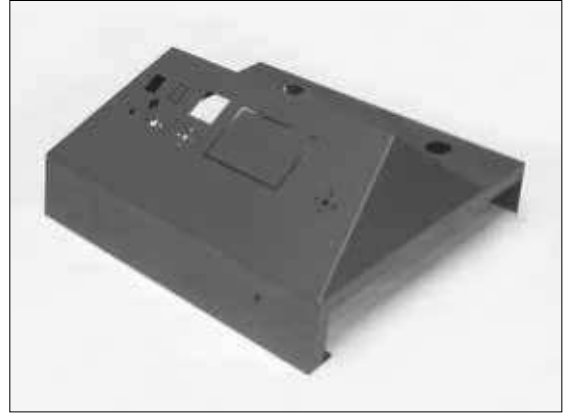

Without label and electronic

Table No. 4 on page 35 – new version

Side hood

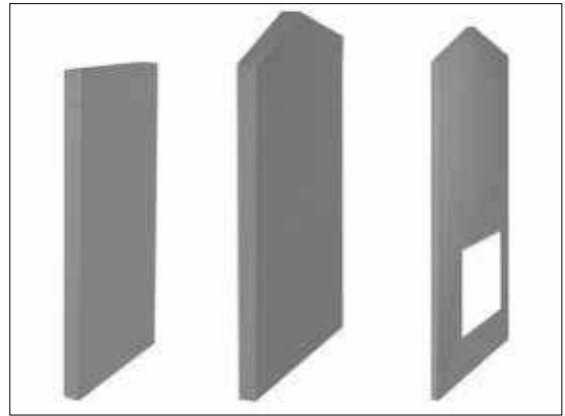

Table No. 5 on page 36 - 37

Instrument board label

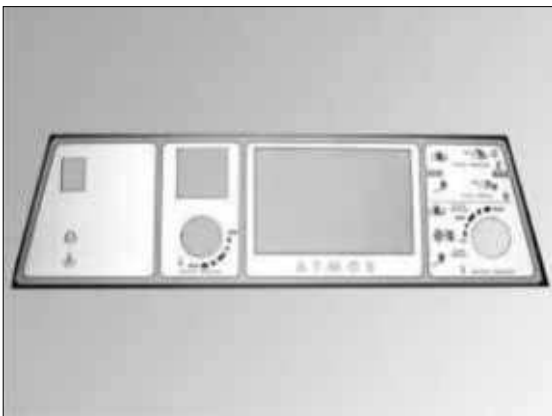

Table No. 3 on page 33 - 34

Front boiler hood – for DC and C boilers



Table No. 6 on page 38

Door cover

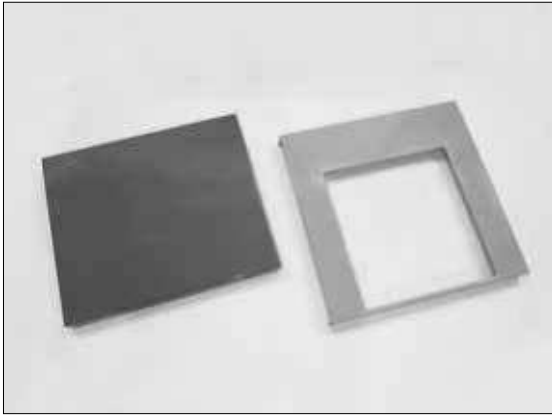

Code: S0381 for small dor – without hole	<i>Price:</i>
	<i>Weight:</i> 1,44 kg
Code: S1265 for big door - without hole DC105S, DC150S,	<i>Price:</i>
	<i>Weight:</i> 1,62 kg
Code: S0391 for big door - without hole DC100, DC75SE, DCxxGSX, GSXxx, D14P, D21P, D25P, D31P, P14, P21, P25, P31, D21 D85P, P85	<i>Price:</i>
	<i>Weight:</i> 1,60 kg
Code: S0393 for big door with hole D15EP(L), DCxxSP(L), DCxxGSP(L), CxxSP(L), ACxxSP(L), KCxxSP(L), DxxPX, PXXx	<i>Price:</i>
	<i>Weight:</i> 1,02 kg
Code: S0415 for small door with hole for burner A25	<i>Price:</i>
	<i>Weight:</i> 0,88 kg
Code: S0984 for small door with hole for burner A45	<i>Price:</i>
	<i>Weight:</i> 0,90 kg
Code: S1106 for tube exchanger doors for boilers D15P - D50P, P15 - P50	<i>Price:</i>
	<i>Weight:</i> 1,04 kg
Code: S1107 for tube exchanger doors for boilers D80P, P80	<i>Price:</i>
	<i>Weight:</i> 1,40 kg

Front cover (door) for pellet boilers D14-25P, P14-25



Code: S1252 front cover (door) for pellet boilers - complete	<i>Price:</i>
	<i>Weight:</i> 11,50 kg
Code: S1460 front cover (door) for pellet boilers - complete set (shorter) - P14 Compact, P21 Compact, P25 Compact	<i>Price:</i>
	<i>Weight:</i> 10,90 kg
Code: S1137 hinge	<i>Price:</i>
	<i>Weight:</i> 0,14 kg
Code: S1198 magnet - with screw, washer and nut	<i>Price:</i>
	<i>Weight:</i> 0,02 kg
Code: S1079 handle for front cover (door) for pellet boilers D14-25P, P14-25	<i>Price:</i>
	<i>Weight:</i> 0,04 kg

Front hood for boilers DxxP

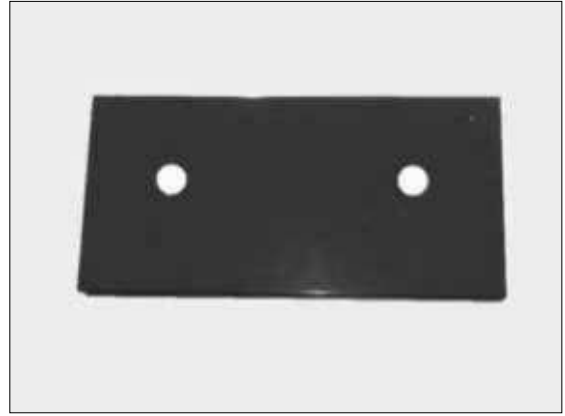

Code: S0343 for boiler D15P – one tube type	<i>Price:</i>
	<i>Weight:</i> 1,38 kg
Code: S0344 for boilers D15P, D20P, D30P, D40P, D50P, P15, P20, P30, P40, P50	<i>Price:</i>
	<i>Weight:</i> 1,38 kg
Code: S0497 upeer hood of cover D30 - with hole	<i>Price:</i>
	<i>Weight:</i> 1,56 kg

Rear boiler hood – for D

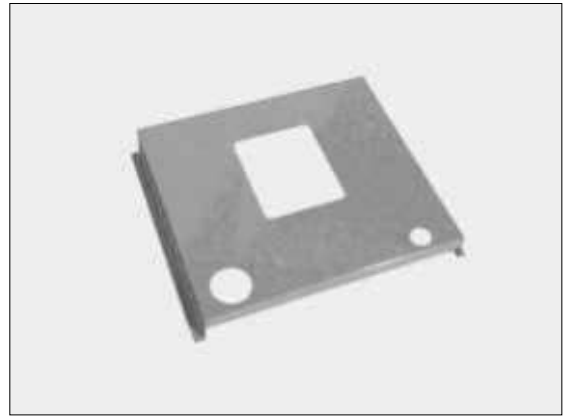
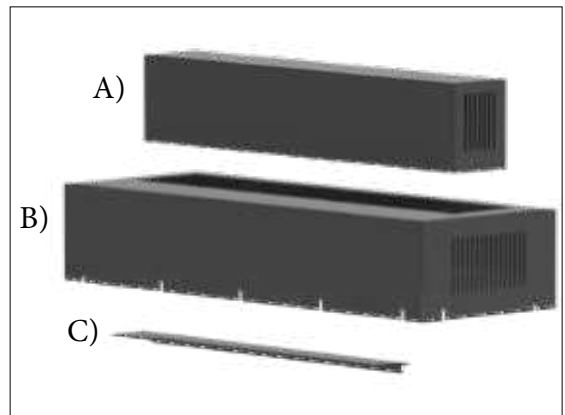

Table No. 7 on page 34

Flue duct cover for the pneumatic cleaning of the tube heat exchanger - D85P, P85



Code: S1574 A) Flue duct cover for the pneumatic cleaning of the tube heat exchanger - movable - D85P, P85	<i>Price:</i>
	<i>Weight:</i> 2,30 kg
Code: S1575 B) Upper flue duct cover for the pneumatic cleaning of the tube heat exchanger - static - D85P, P85	<i>Price:</i>
	<i>Weight:</i> 3,70 kg
Code: S1576 C) Upper cover of insulation of the flue duct	<i>Price:</i>
	<i>Weight:</i> 0,40 kg

Cover of front lid for tube heat exchange - for DC100, DC105S, DC150S

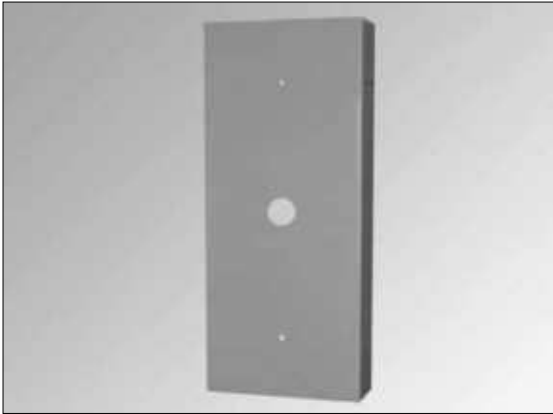

Code: S0958 for boiler DC100 – cover of lid for tube heat exchanger	<i>Price:</i>
	<i>Weight: 0,90 kg</i>
Code: S0964 for boilers DC105S, DC150S – cover of lid for tube heat exchanger	<i>Price:</i>
	<i>Weight: 1,25 kg</i>

Rear shield

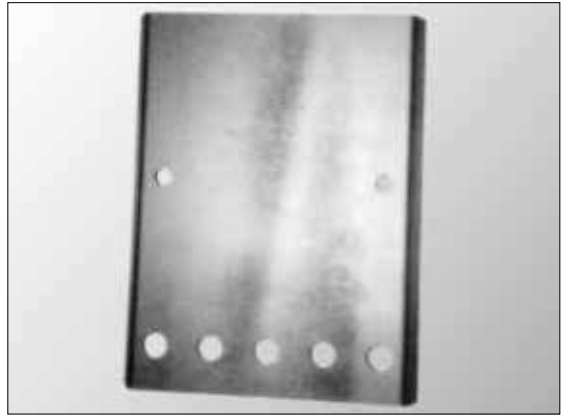

Code: S0449 for boilers DC40SE, DC50SE, DC75SE	<i>Price:</i>
	<i>Weight: 2,27 kg</i>

Front vertical hood for boiler DC100, DC105S, DC150S



Code: S0957 hood for boiler DC100, DC105S, DC150S front vertical	<i>Price:</i>
	<i>Weight: 1,98 kg</i>

Nozzle shield DC50SE

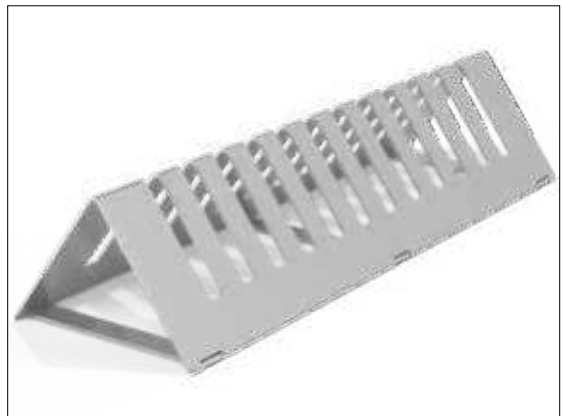

Code: S1577 Nozzle screen DC50SE, DC70S	<i>Price:</i>
	<i>Weight: 6,05 kg</i>

Flue way heating insulation cover

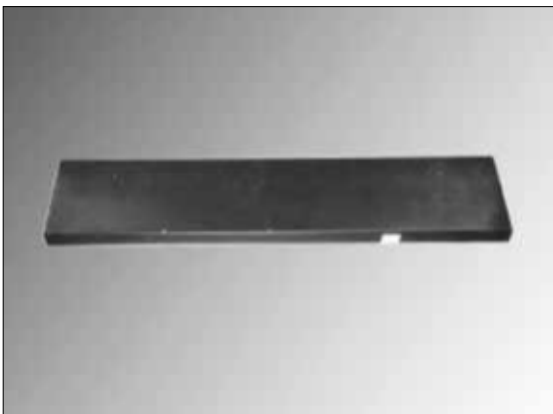
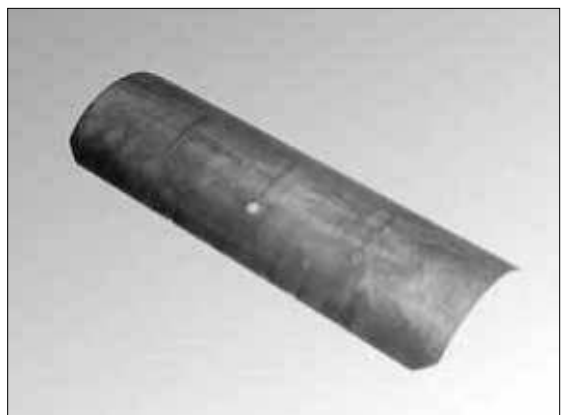

Table No. 8 on page 39

Lining of gasifying chamber DC50SE – 1 pc



Code: S0448 2 pcs in 1 boiler	<i>Price:</i>
	<i>Weight: 8,28 kg</i>

Frame shields

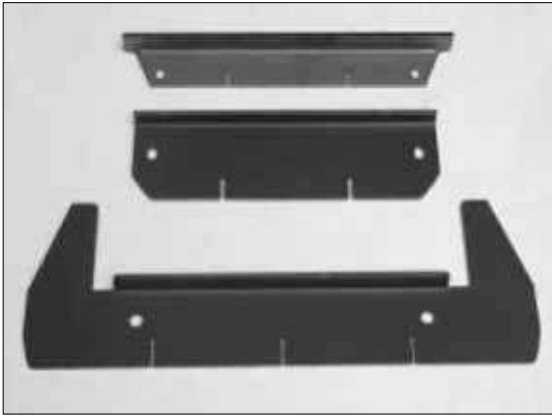
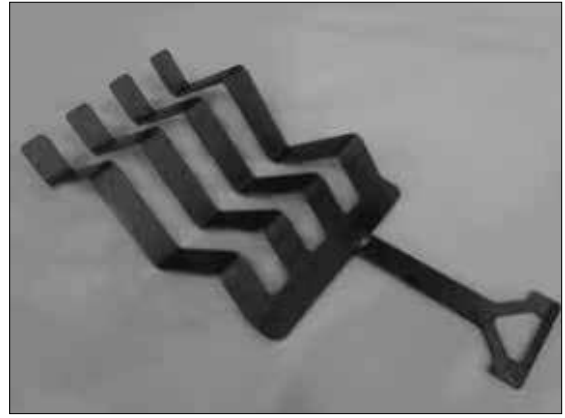

Table No. 9 on page 40

Waste gas brake for rear flue way duct - 4 arm



Code: S0421 fourarm - for DC25SF, DC30SF, DC30SX, ACxxS - lenght 370 mm	<i>Price:</i>
	<i>Weight: 0,74 kg</i>

Shield – front stainless D14P, D21P, D25P, P14, P21, P25

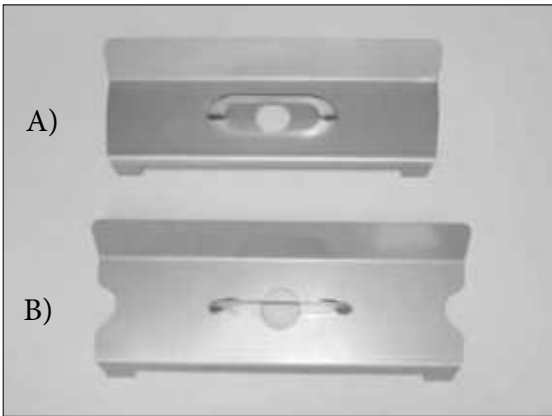

Code: S0937 A) for boilers D21P, D25P, P21, P25, D31P, P31	<i>Price:</i>
	<i>Weight: 0,96 kg</i>
Code: S0936 B) for boilers D14P, P14	<i>Price:</i>
	<i>Weight: 0,94 kg</i>

Shield – front stainless - D85P, P85

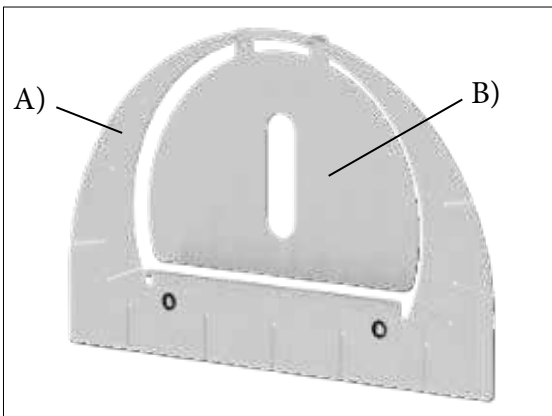

Code: S1578 A) frame shield for hanging the front removable shield	<i>Price:</i>
	<i>Weight: 4,20 kg</i>
Code: S1579 B) removable stainless steel front shield with viewing window	<i>Price:</i>
	<i>Weight: 3,00 kg</i>

Waste gas brake for rear flue way duct - 5 arm

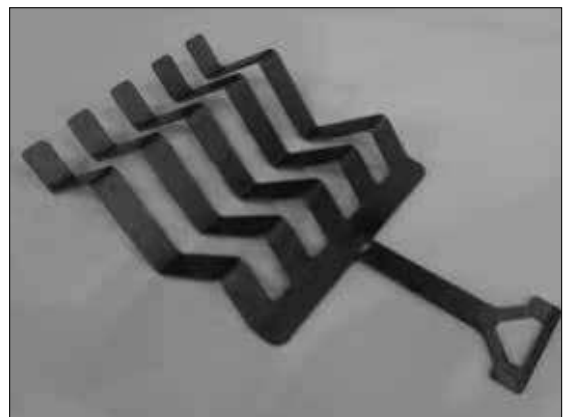

Code: S0422 fivearm – for DC32GS, DC40GS, DC40SX, DC50S, DC70S, DC35SF, DCxxSE – lenght 365 mm	<i>Price:</i>
	<i>Weight: 0,92 kg</i>
Code: S0965 fivearm – for DC105S, DC150S - 2x for boiler - lenght 475 mm	<i>Price:</i>
	<i>Weight: 1,31 kg</i>

Waste gas brake along the spherical chamber

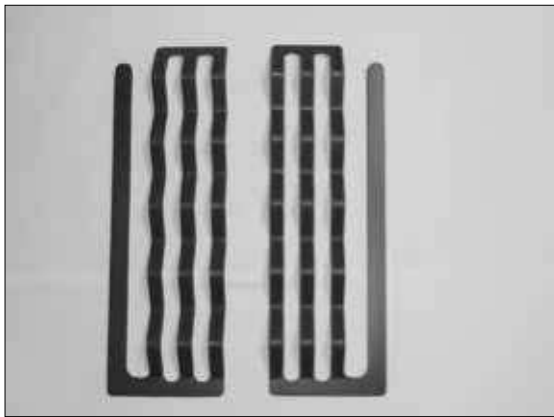

Code: S0430 air brake – left + right (2 pcs) – for DC22GSE, DC25GSE - old version, DC18S, GS20, DC18GSP - pellets, AC25S, AC35S, AC45S, KC25S, KC35S, KC45S – lenght 290 mm	<i>Price:</i> <i>Weight:</i> 1,74 kg
Code: S0429 air brake – left + right (2 pcs) – for DC30GSE, DC50GSX, DC60GSX DC30GSP - wood, GSX50, GSX60, C50S – lenght 470 mm	<i>Price:</i> <i>Weight:</i> 2,78 kg
Code: S1309 air brake – left + right (2 pcs) – for DC70GSX, GSX70 (chamber 800 mm) – lenght 650 mm	<i>Price:</i> <i>Weight:</i> 1,46 kg

Flue way air-break

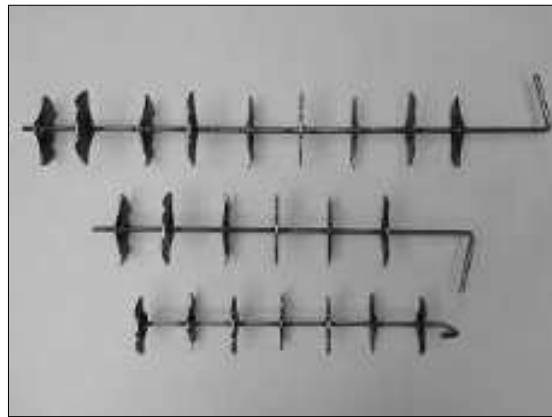

Code: P0098 for D14P, D21P, P14, P21 – 490 mm - Ø 93 mm	<i>Price:</i> <i>Weight:</i> 0,70 kg
Code: P0210 for D25P, D31P, P25, P31 – 590 mm - Ø 93 mm	<i>Price:</i> <i>Weight:</i> 0,88 kg
Code: P0099 for DC50-60GSX, GSX50-60 – 830 mm - Ø 118 mm	<i>Price:</i> <i>Weight:</i> 1,36 kg
Code: P0221 for DC70GSX, GSX70 – 930 mm - Ø 118 mm	<i>Price:</i> <i>Weight:</i> 1,50 kg
Code: P0087 for DC30RS – 596 mm - Ø 118 mm	<i>Price:</i> <i>Weight:</i> 0,92 kg
Code: P0217 for D30P, D40P, P30, P40 – outer – 678 mm Ø 118 mm	<i>Price:</i> <i>Weight:</i> 1,05 kg
Code: P0218 for D50P, P50 – outer – 884 mm - Ø 118 mm	<i>Price:</i> <i>Weight:</i> 1,36 kg
Code: P0084 for D21 – 410 mm - Ø 93 mm	<i>Price:</i> <i>Weight:</i> 0,53 kg
Code: P0219 for D80P, P80 – 1084 mm - Ø 118 mm	<i>Price:</i> <i>Weight:</i> 1,06 kg
Code: P0019 for D85P, P85 – 789 mm - Ø 118 mm	<i>Price:</i> <i>Weight:</i> 1,70 kg
Code: P0239 for DC105S – 628 mm - Ø 118 mm	<i>Price:</i> <i>Weight:</i> 0,92 kg
Code: P0240 for DC150S – 828 mm - Ø 118 mm	<i>Price:</i> <i>Weight:</i> 1,16 kg
Code: P0487 for D10PX, PX10 – 485 mm - Ø 93 mm	<i>Price:</i> <i>Weight:</i> 0,58 kg
Code: P0482 for D15-25PX, PX15-25 – 685 mm - Ø 93 mm	<i>Price:</i> <i>Weight:</i> 0,80 kg

Waste gas brake into the lower chamber - under roof

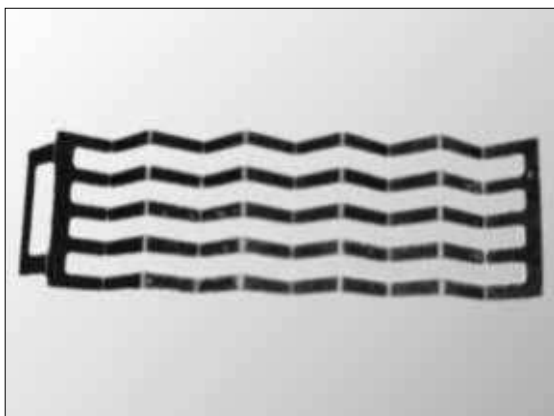

Code: S0990 – lenght 300 mm for DC22SX, DC25SFSX	<i>Price:</i> <i>Weight:</i> 1,30 kg
Code: S0427 small – lenght 500 mm for DC40SE, DC30SX, DC40SX, DC40SE	<i>Price:</i> <i>Weight:</i> 2,06 kg
Code: S0425 middle – lenght 600 mm for DC50SE, DC50S	<i>Price:</i> <i>Weight:</i> 2,02 kg
Code: S0426 long – lenght 860 mm for DC75SE	<i>Price:</i> <i>Weight:</i> 2,78 kg

Waste gas brake for tube heat exchanger - GSE, GD, GSP(L), AC, KC

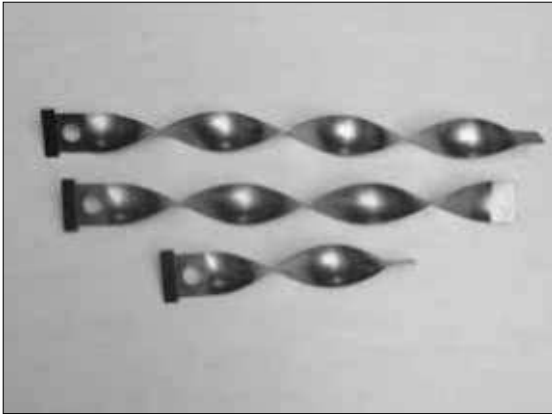

Code: S0305 for boilers DC18GSE (GD), DC22GSE, DC25GSE (GD), DC30GSE (GD), DCxxGSP(L), AC35S, KC35S – lenght 330 mm	<i>Price:</i> <i>Weight:</i> 0,28 kg
Code: S0308 for boilers DC40GSE, (GD) – lenght 430 mm	<i>Price:</i> <i>Weight:</i> 0,34 kg
Code: S0309 for boilers DC50GSE, (GD) – lenght 710 mm	<i>Price:</i> <i>Weight:</i> 0,56 kg
Code: S0310 for boilers C50S – lenght 630 mm	<i>Price:</i> <i>Weight:</i> 0,48 kg
Code: V0344 tool for pulling out the waste gas brakes	<i>Price:</i> <i>Weight:</i> 0,38 kg

Pneumatic cleaning of the tube heat exchanger for boilers D85P, P85

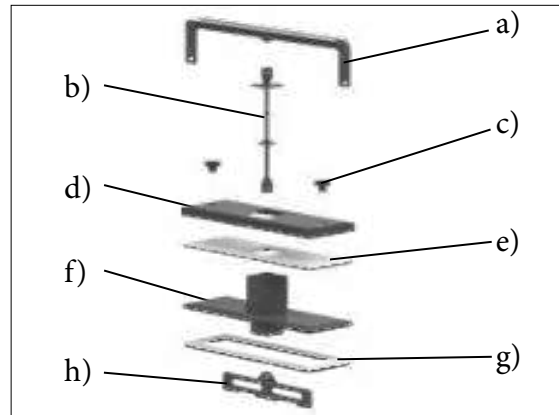

Code: S1580 a) Waste gas brake lever	<i>Price:</i> <i>Weight:</i> 2,30 kg
Code: S1581 b) Draw bar of the pneumatic cleaning with springs	<i>Price:</i> <i>Weight:</i> 0,60 kg
Code: S0411 c) plastic nut M8	<i>Price:</i> <i>Weight:</i> 0,06 kg
Code: S1582 d) lid insulation cover	<i>Price:</i> <i>Weight:</i> 1,82 kg
Code: S1414 e) top insulation of the lid	<i>Price:</i> <i>Weight:</i> 0,32 kg
Code: S1583 f) cover of the tube heat exchanger	<i>Price:</i> <i>Weight:</i> 5,00 kg
Code: S1584 g) lid sealing cord 14 x 14 x 1340	<i>Price:</i> <i>Weight:</i> 0,13 kg
Code: S1585 h) holder of the waste gas brake	<i>Price:</i> <i>Weight:</i> 0,80 kg

Waste gas brake - brush



Code: P0058 brush air break for D20P – lenght 450 mm	<i>Price:</i> <i>Weight:</i> 0,24 kg
Code: P0063 brush air break for D30P, D40P, P30, P40 – lenght 630 mm	<i>Price:</i> <i>Weight:</i> 0,40 kg
Code: P0064 brush air break for D50P (D45P), P50 – lenght 810 mm	<i>Price:</i> <i>Weight:</i> 0,48 kg

Pneumatic cleaning cylinder for D85P, P85



Code: S1427 Pneumatic cleaning cylinder of tube heat exchanger for D85P, P85	<i>Price:</i> <i>Weight:</i> 0,40 kg
---	---

Pneumatic connection for exchanger cleaning - D85P, P85



Code: S1586 pneumatic connection - reduction and fixing cap - D85P, P85	<i>Price:</i>
	<i>Weight: 0,46 kg</i>

Cement



Table No. 10 on page 41

Pocket for flue gas sensors / thermometer



Code: P0033 pocket for flue gas thermometer - with locking screw G1/2" 107 mm	<i>Price:</i>
	<i>Weight: 0,10 kg</i>
Code: V0925 pocket for flue gas sensors - DxxPX, PXxx G1/2" - 99 mm	<i>Price:</i>
	<i>Weight: 0,10 kg</i>
Code: V0524 pocket for flue gas sensors for flue gas duct G1/2" 85 mm	<i>Price:</i>
	<i>Weight: 0,09 kg</i>
Code: V0517 pocket for flue gas sensors - D30P, D40P, D50P (D45P) G1/2" - 55 mm	<i>Price:</i>
	<i>Weight: 0,06 kg</i>

Pocket - G1/2"



Code: S0047 with 4 holes inside with a spring – for all types of boilers – serves for holding the sensors or other sensing units	<i>Price:</i>
	<i>Weight: 0,06 kg</i>

Spare parts for boilers with automatic wood ignition - AIW

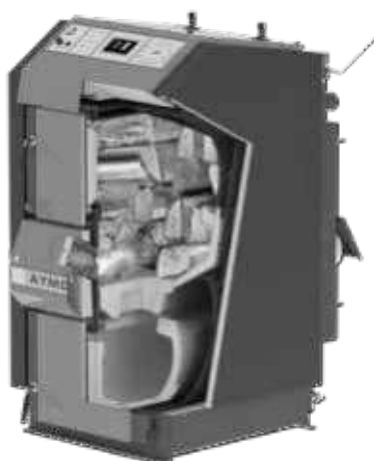

Ignition chamber - AIW



Code: S1494 spare ignition chamber for AIW

<i>Price:</i>
<i>Weight:</i> 0,70 kg

Holder - plate for the ignition coil - AIW

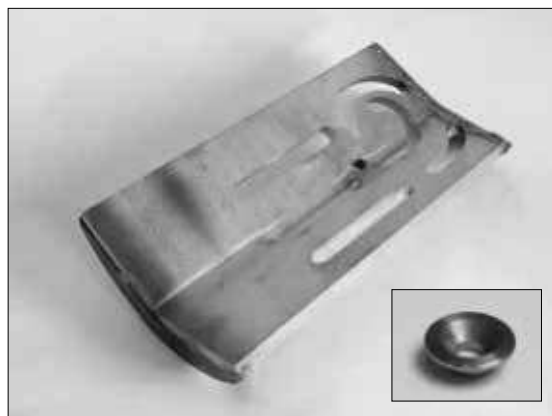

Code: S1493 holder - plate with holes for ignit. coil for automatic wood ignition - AIW

<i>Price:</i>
<i>Weight:</i> 0,40 kg

Code: V0954 washer - ignition coil holder - AIW

<i>Price:</i>
<i>Weight:</i> 0,01 kg

Ignition cap - AIW (complete)



Code: S1537 replacement complete ignition cap for AIW
red/blue - color must be specified

<i>Price:</i>
<i>Weight:</i> 0,70 kg

Ignition coil - AIW



Code: S1497 replacement ignition coil for AIW - 230 V / 500 W

<i>Price:</i>
<i>Weight:</i> 0,18 kg

Code: S1463 replacement electrical harness for ignition coils for AIW

<i>Price:</i>
<i>Weight:</i> 0,10 kg

Locking nut - AIW



Code: V0951 replacement ignition lock nut for AIW

Price:

Weight: 0,10 kg

Shovel for AIW

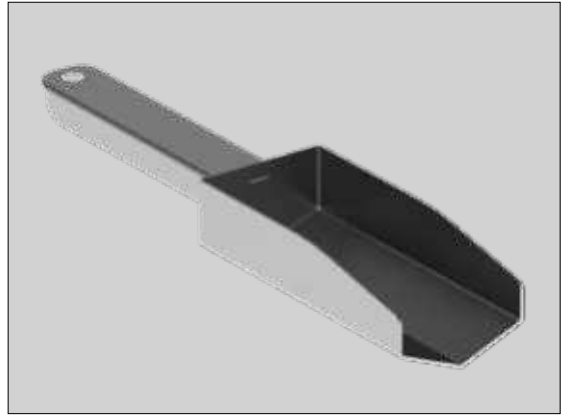

Code: S1496 spare shovel for ignition batch of pellets for AIW

Price:

Weight: 0,10 kg

Blanking pad for ignition coil



Code: S1538 spare blanking pad for AIW ignition coil

Price:

Weight: 0,04 kg

Accessory pocket



Code: S1539 pocket for AIW accessories for mounting on the side of the boiler or on the wall - without accessories

Price:

Weight: 0,70 kg

Blanking cap of the ignition - AIW



Code: S1495 spare blanking cap of the ignition for AIW

Price:

Weight: 0,70 kg

Control unit AC32



Code: P0498 spare control unit AC32 for electromechanic adjustment of automatic wood ignition (AIW) based on time or tank temperature

Price:

Weight: 0,48 kg

Code: S1506 spare black knob for control unit AC32

Price:

Weight: 0,01 kg

Table No. 1 - Electrical Equipment

Electrical Equipment for boilers	Code	Price	Weight
DC18S, DC22S, DC25S, DC32S, DC50S, DC70S, DC80, DC22SX, DC30SX, DC40SX, DC15GS, DC20GS, DC25GS, DC32GS, DC40GS, DC18GD, DC25GD, DC30GD, DC40GD, DC50GD, DC30SE, DC40SE, DC50SE, C15S, C18S, C20S, C25ST, C30S, C32ST, C40S, C50S, AC16S, AC25S, AC35S, AC45S DC24RS-CZ, DC30RS-CZ, DC25SF, DC30SF, DC35SF, DC40SF, DC50SF, DC50GSX-CZ, DC60GSX-CZ, DC70GSX-CZ, DCxxSR(X)	S0664		0,64 kg
DC18GSE, DC22GSE, DC25GSE, DC30GSE, DC40GSE, DC50GSE, DC24RS-DE, DC30RS-DE, DC50GSX-DE, DC60GSX-DE, DC70GSX-DE, GSxx, GSxxx, KCxxS	S0660		0,82 kg
DC15E, D15, D20, D21, D30, DC14R - unified design	S0643		0,62 kg
DC100, DC100TF	S0651		1,05 kg
D20P, D30P, D40P, D50P, P20, P30, P40, P50, D31P, P31 - unified design	S0645		1,02 kg
D15P, D14P, D21P, D25P, P14, P21, P25 (Compact) - unified design	S0663		1,48 kg
D80P, P80	S1085		1,64 kg
D85P, P85	S1443		2,80 kg
DC15EP(L)	S0652		1,14 kg
DC18SP(L), DC25SP(L), DC32SP(L), C18SP(L), KC25SP(L)	S0655		1,06 kg
DCxxSP(X) - model 2018/2019 - since 1.3.2018, from serial number 343500	S1260		2,20 kg
DCxxSP(X)L - model 2018/2019 - since 1.3.2018, from serial number 343521	S1261		2,05 kg
DC75SE, DC75SF	S0649		1,08 kg
Electrical bundle for boilers with equithermal regulation ACD 01 - DCxxS, DCxxGS, DCxxGD, GSxx	S0654		0,60 kg
Electrical bundle for boilers with equithermal regulation ACD 04 - DCxxS, DCxxGS, DCxxGD, DCxxGSE, GSxx	S1442		0,94 kg
Boilers with modification for pellet burner in upper door	S0719		0,94 kg
DCxxGSP	S0741		2,10 kg
DCxxGSPL	S0750		2,24 kg
DC105S, DC150S	S1150		1,36 kg
Boilers with modification for burner - model (2x AC03), from serial number 327700	S1144		1,88 kg
D10PX, PX10 (new with separate working zero - from v. no. 358184)	S1347		1,72 kg
D15PX, D20PX, D25PX, PX15, PX20, PX25 (new with separate working zero - from v. no. 358184)	S1145		2,02 kg
The extension of the electrical bundle for automatic ignition AIW + ACD 04 / AC32 DCxxS(X), DCxxGS, DCxxGD	S1463		0,10 kg

Table No. 2 - Firing up rod

Boiler type	Lenght	Code	Price	Weight
DC15E, DC18S, DC20GS, DC18GSE, DC22GSE, DC22SX, DC18GD, C18S, C20S, AC25S, AC35S, KC25S, KC35S, DC14R, DC24RS, DC30RS, DC15EP(L), DC18SP(L), CxxSP(L), ACxxSP(L), KCxxSP(L), DC18GSP(L), DC25GSE - old version	620	V0465		0,16 kg
C30S, AC45S, KC45S	720	V0466		0,20 kg
C15S, KC16S, DC15GS, GS15	520	V0470		0,14 kg
DC22S, DC25S, DC25GS, DC32S, DC32GS, DC40GS, DC40SE, DC30GSE, DC40GSE, DC50GSE, DC25GSE since 15.4.2012, DC25GD, DC30GD, DC40GD, DC50GD, C40S, C50S, DC30SX, DC40SX, DC25GSP(L), DC30GSP(L), DCxxGSX, GSXxx,	820	V0467		0,21 kg
DC50S, DC50SE, DC80, DC70S, DC70GSX (chamber 800 mm)	1020	V0468		0,26 kg
DC75SE	1320	V0469		0,58 kg
DC100, DC150S	1045	V0474		0,46 kg
DC105S	860	V0475		0,36 kg

Table No. 3 - Dash board labels

Boiler type	Type	Code	Price	Weight
DC18S, DC22S, DC25S, DC32S, DC50S, DC70S, DC80, DC30SE, DC40SE, DC50SE, DC75SE, DC22SX, DC30SX, DC40SX, C15S, C18S, C20S, C25ST, C30S, C32ST, C40S, C50S, AC16S, AC25S, AC35S, AC45S	CZ/EN	S0371		0,03 kg
DC15GS, DC20GS, DC25GS, DC32GS, DC40GS, DC18GD, DC25GD, DC30GD, DC40GD, DC50GD, DC50GSX-CZ, DC60GSX-CZ, DC70GSX-CZ, DC24RS, DC30RS	CZ/EN	S0597		0,03 kg
DC100, DC105S, DC150S	CZ/EN	S0373		0,03 kg
DC15E	CZ/EN	S1095		0,03 kg
D15, D20, D21, D30	CZ/EN	S0372		0,03 kg
DC14R	CZ/EN	S0524		0,03 kg
D15P, D20P, D30P, D40P, D50P, D80P D14P, D21P, D25P, D31P,	CZ/EN	S0384		0,03 kg
D85P	CZ/EN	S1402		0,03 kg
D15P – old version	CZ/EN	S0383		0,03 kg
DC18SP(L), DC25SP(L), DC30SPX(L), DC32SP(L), CxxSP(L)	CZ/EN	S0593		0,03 kg
DC15EP(L)	CZ/EN	S0595		0,03 kg
DCxxS with ACD 01	CZ/EN	S0402		0,03 kg
DCxxGS, DCxxGD with ACD 01	CZ/EN	S0528		0,03 kg
Boilers with modification for burner - model (2x AC03), from serial number 327700	CZ/EN	S1230		0,03 kg
D10PX	CZ/EN	S1200		0,03 kg
D15PX, D20PX, D25PX	CZ/EN	S1336		0,03 kg
DCxxS(X) with ACD 04	CZ/EN	S1352		0,03 kg
DCxxGS, DCxxGD with ACD 04	CZ/EN	S1393		0,03 kg
D10PX s ACD 04	CZ/EN	S1345		0,03 kg
D15PX, D20PX, D25PX with ACD 04	CZ/EN	S1395		0,03 kg
DCxxSP(X) with ACD 04	CZ/EN	S1397		0,03 kg
DCxxS(X) with AC32 + AIW	CZ/EN	S1565		0,03 kg
DC18SF, DC25SF, DC30SF, DC35SF, DC40SF, DC50SF, DC70TF, DC75SF	SE	S0374		0,03 kg
DC100TF	SE	S0376		0,03 kg

DC18S, DC50SE, DC40SE, DC75SE, DC30SE, KCxxS	DE	S1300		0,03 kg
DC20GS, DC25GS, DC32GS, DC40GS, GSxx, GSXxx	DE	S0377		0,03 kg
- boilers with a second flue gas thermostat DC18GSE, DC22GSE, DC25GSE, DC30GSE, DC40GSE, DC50GSE, DC30RS-DE, DC50GSX-DE, DC60GSX-DE, DC70GSX-DE, GSxx, GSXxx,	DE	S0378		0,03 kg
DC15E	DE	S1096		0,03 kg
D15, D20, D30	DE	S0375		0,03 kg
DC14R	DE	S0522		0,03 kg
D15P – old version	DE	S0385		0,03 kg
P15, P20, P30, P40, P50, P14, P21, P25, P31	DE	S0386		0,03 kg
DC18SP(L), DC25SP(L), DC32SP(L), DCxxGSP(L), KCxxSP(L)	DE	S0594		0,03 kg
DCxxGSP with ACD 01	DE	S1587		0,03 kg
DC15EP(L)	DE	S0596		0,03 kg
DCxxGSE with ACD 01	DE	S0529		0,03 kg
PX10	DE	S1208		0,03 kg
PX15, PX20, PX25	DE	S1337		0,03 kg
DCxxS(X) with ACD 04	DE	S1392		0,03 kg
DCxxGS, DCxxGSE with ACD 04	DE	S1394		0,03 kg
PX10 with ACD 04	DE	S1346		0,03 kg
PX15, PX20, PX25 with ACD 04	DE	S1396		0,03 kg
DCxxGSP with ACD 04	DE	S1398		0,03 kg
P85	DE	S1403		0,03 kg
DC18S, DC20GS, DC25GS, DC32GS, DC40GS, DC40SE, DC50SE, DC75SE, DC30SE,	SIEGER	S0387		0,03 kg
FBV22-FBV50	SIEGER	S0523		0,03 kg
DC15E	SIEGER	S0388		0,03 kg
D15P, D20P, D30P, D40P, D50P, D80P, P15, P20, P30, P40, P50, P80	SIEGER	S0390		0,03 kg
CBI xx S	DeDietrich	S0667		0,03 kg
CBI xx GS	DeDietrich	S1351		0,03 kg

ATTENTION – specify color in the order

YELLOW (RAL 1003)	LIGHT GREY (RAL 7042)
BLUE (RAL 5015)	DARK GREY (RAL 7024)
RED (RAL 3000)	WHITE (RAL 9016)

Table No. 4 - Dash board with prolongation - without sticker– with holes for cooling loop

Boiler type	Wide	Deepness	Code	Price	Weight
DC15E, DC18S, DC25SF, D15, C18S, C20S, C25ST, DC22SX, AC25S, AC35S, KC25S, KC35S	540	480	S0311		4,20 kg
DC20GS, DC18GSE, DC18GD, DC22GSE (GD), DC14R, DC24RS, DC30RS, GS20, DC25GSE - old version	540	480	S0299		4,08 kg
DC35SF, DC40SF, DC40SE, DC30SE, C40S, DC22S, DC25S, DC32S, DC30SX, DC40SX, D20, D21, D30	540	680	S0312		5,32 kg
DC25GS, DC32GS, DC40GS, DC30GSE, DC30GD, DC40GSE, DC40GD, DC50GSE, DC50GD, GS25 - GS40, GSXxx, DC25GD DC25GSE - since 15.4.2012	504	680	S0306		5,32 kg
DC15GS, GS15	504	390	S1301		3,60 kg
DC50GSX, DC60GSX, DC70GSX (chamber 600 mm)	504	680	S0369		5,30 kg
DC70GSX (chamber 800 mm)	504	880	S1360		6,05 kg
C15S, KC16S	504	380	S1097		3,02 kg
C30S, C32ST, AC45S, KC45S	540	580	S0462		5,00 kg
DC50SE, DC50SF, DC50S, DC80, DC70S	540	880	S0313		7,00 kg
DC75SE	540	118	S0314		7,40 kg
D15P, D20P	540	480	S0296		4,08 kg
DC100, DC150S	915	922	S0439		10,48 kg
DC105S	915	722	S1178		8,31 kg
DC15EP(L), DC18SP(L) CxxSP(L), KCxxSP(L) DC18GSP(L)	540	480	S0463		4,20 kg
DC25SP(L), DC32SP(L) DC25GSP(L), DC30GSP(L)	540	680	S0464		5,32 kg
DC18GSP(L) s ACD01	540	480	S1266		4,10 kg
DC25GSP(L), DC30GSP(L) with ACD01	540	680	S1267		5,22 kg
D30P, D40P, P30, P40	540	680	S0315		5,32 kg
D50P, P50	540	880	S0316		7,00 kg
D14P, D21P, P14, P21 - without cooling loop	540	559	S0318		3,90 kg
D25P, P25, D31P, P31 - without cooling loop	540	680	S0368		5,26 kg
DC22GSE for ACD01	540	680	S0320		4,10 kg
D14P, D21P, P14, P21 - without cooling loop - boilers with front cover (door)	540	559	S1243		3,90 kg
D25P, P25 - without cooling loop - boilers with front cover (door)	540	680	S1251		5,26 kg
D80P, P80	540	1010	S1238		6,99 kg
D85P, P85	699	920	S1588		9,00 kg
for ACD01 - DC18GD, DC18GSE, DC22GSE	540	680	S0320		4,10 kg
for ACD01 - DC25GS, DC25GDE, DC30GD, DC25GSE, DC30GSE	540	680	S0329		5,10 kg
for ACD01 - DC18S	540	680	S0330		3,84 kg
for ACD01 - DC25S, DC32S	540	680	S0399		4,76 kg
for ACD 04 - DC18GD, DC18GSE, DC22GSE	540	680	S1589		4,10 kg
for ACD 04 - DC25GS, DC25GDE, DC30GD, DC25GSE, DC30GSE	540	680	S1590		5,10 kg
for ACD 04 - DC18S	540	680	S1323		3,84 kg
for ACD 04 - DC25S, DC32S, DC40SX	540	680	S1324		4,76 kg
for AIW with AC32 - DC32S, DC40SX	540	680	S1591		4,76 kg
D10PX, PX10	503	303	S1361		3,90 kg
D15PX, D20PX, D25PX, PX15, PX20, PX25	540	550	S1268		4,30 kg

Table No. 5 - Side hood

Boiler type	Wide	High	Deepness	Code		Price	Weight
				Left side	Right side		
DC15E, C18S, D15, DC18S, AC25S - narrow	25	925	485	S0321	S0322		4,52 kg
D20, D21, DC22S, DC25S, DC30SX - narrow	25	925	685	S0323	S0324		6,10 kg
- wide hoods since 2015 - DC22S, DC25S, DC30SX	66	925	685	S0327	S0328		7,34 kg
DC32S, DC40SX, DC30SE	66	1020	675	S0325	S0326		7,70 kg
DC15GS, GS15	66	1120	395	S1269	S1270		4,88 kg
DC25GS, DC32GS, DC30GD, DC25GD DC25GSE since 15.4.2012, DC30GSE	66	1120	685	S0561	S0562		8,10 kg
DC25GSE - old version	66	1225	485	S0563	S0564		8,25 kg
DC20GS, DC18GSE, DC22GSE (GD) DC18GD, DC24RS, DC30RS	66	1120	485	S0565	S0566		10,05 kg
DC40GS, DC40GD, DC50GD DC40GSE, DC50GSE	66	1225	685	S0567	S0568		9,20 kg
DC50GSX, DC60GSX	66	1360	685	S0575	S0576		9,70 kg
DC70GSX (chamber 600 mm)	66	1460	685	S0569	S0570		9,80 kg
DC70GSX (chamber 800 mm)	66	1460	885	S1311	S1312		12,70 kg
DC50S, DC70S (80)	66	1015	870	S0331	S0332		7,60 kg
DC100	26	1250	900	S0333	S0334		10,36 kg
DC40SE	115	1125	670	S0364	S0365		8,95 kg
DC50SE	115	1125	870	S0335	S0336		9,30 kg
C15S	25	925	385	S1319	S1320		3,66 kg
C20S, AC35S, KC35S - narrow	26	1117	482	S0337	S0338		5,58 kg
C30S, AC45S, KC45S - narrow	26	1117	582	S0339	S0340		6,10 kg
C40S, C50S, D30	26	1117	682	S0341	S0342		7,86 kg
DC75SE – front	115	1230	585	S0347	S0348		9,58 kg
DC75SE – rear	115	1230	585	S0349	S0350		9,58 kg
D20P, D15P – with hole – without coffin	40	1117	485	S0394	S0395		5,36 kg
D20P, D15P – without hole – without coffin	40	1117	485	S0396	S0397		5,58 kg
DC18SP(L), DC15EP(L), CxxSP(L), KCxxSP(L)	50	1240	485	S0476	S0477		6,70 kg
DC25SP(L)	50	1240	685	S0478	S0479		7,20 kg
C25SP(L), AC32SP(L), KC32SP(L)	50	1380	485	S1271	S1272		7,30 kg
DC18GSP(L)	66	1310	485	S1273	S1274		6,90 kg
DC32SP(L), DC25GSP(L), DC30GSP(L),	66	1240	675	S0494	S0495		6,90 kg
D30P, D40P, P30, P40 – with hole	40	1117	685	S0606	S0605		6,56 kg
D50P, P50 – with hole	40	1117	885	S0608	S0607		7,10 kg
DC14R	66	1035	485	S0585	S0586		7,50 kg
KC16S	66	925	385	S1099	S1100		4,43 kg
KC25S, DC22SX - wide hoods since 2015 - DC15E, DC18S, C18S, AC25S	66	925	485	S0587	S0588		5,60 kg
KC35S - wide hoods since 2015 - C20S, C25ST, AC35S	66	1117	482	S0557	S0558		6,90 kg
KC45S - wide hoods since 2015 - C30S, C32ST, AC45S	66	1117	582	S0559	S0560		7,80 kg
- wide hoods since 2015 - C40S, C50S	66	1117	682	S1117	S1118		8,54 kg
D14P, D21P, P14, P21 - old version	40	958	583	S0589	S0590		5,84 kg
D25P, P25 - old version	40	958	683	S0621	S0622		6,70 kg
D31P, P31 - old version	40	1200	683	S1303	S1303		7,09 kg
D80P, P80	70	1504	1100	S1179	S1180		15,16 kg

D14P, D21P, P14, P21 - boilers with front cover (door)	40	958	583	S1241			5,84 kg
D25P, P25 - boilers with front cover (door)	40	958	683	S1247			6,70 kg
D14P, D21P, P14, P21 - boilers with front cover (door)	40	958	583		S1242		5,84 kg
D25P, P25 - boilers with front cover (door)	40	958	683		S1248		6,70 kg
D10PX, PX10	45	1180	625	S1363	S1364		7,20 kg
D15PX, D20PX, PX15, PX20	65	1320	685	S1255	S1256		11,73 kg
DC105S	45	1325	700	S1181	S1182		9,14 kg
DC150S	45	1325	900	S1183	S1184		11,44 kg
D85P, P85 with extension (cover)	119	1485	900	S1593	S1594		13,82 kg

INFO - implementation of wide side hoods from serial number					
boiler type:	from serial number:	boiler type:	from serial number:	boiler type:	from serial number:
DC18S	300830	C18S	301151	DC25S - Riello	300700
DC22S	300800	C20S	302101	-	-
DC25S	300700	-	-	-	-

Table No. 6 - Front side DC and C boilers

Boiler type	Wide	High	Popis	Code	Price	Weight
DC15E, DC18S, DC22S , DC25S, DC22SX, DC30SX, - upper - big DC15EP(L), DC25SP(L), DC18SP(L),	575	190		S0351		1,26 kg
C18S, KC16S, AC25S, KC25S - upper - big C18SP(L), AC25SP(L), KC25SP(L)	575	190	with hole	S0352		1,24 kg
- upper - big C25SP(L), AC32SP(L), KC32SP(L)	575	254	with hole	S1275		1,54 kg
DC32S, DC40SX, DC15GS, DC20GS, DC25GS, DC32GS, GS15, GS20, GS25, GS32 DC50S - old version, DC18GSE, DC22GSE, DC30GSE, DC18GD, DC25GD, DC30GD DC25GSE - since 15.4.2012 - upper - big DC32SP(L), DCxxGSP(L)	655	265		S0353		1,86 kg
- with hole and plug for AIW (automatic wood ignition) DC32S, DC40SX, DC18GD, DC25GD, DC30GD, DC18GSE, DC25GSE, DC30GSE	655	265	with hole	S1592		1,25 kg
DC50S - new version since 2012	575	265	with hole	S0581		1,66 kg
DC14R	655	190	with hole	S0582		1,80 kg
DC24RS, DC30RS	655	265	with hole	S0583		2,96 kg
DC50GSX, DC60GSX, GSX50, GSX60		470		S0584		3,10 kg
DC70GSX, GSX70	655	591		S0466		1,82 kg
DC32SP(L) - upper	575	265		S0354		2,76 kg
C20S, C25ST, C30S, C32ST, C40S, AC35S, AC45S, KC35S, KC45S	665	440	with hole	S0355		2,78 kg
DC40GS, GS40, DC70S(80), DC40GSE, DC40GD, DC25GSE - old version	665	425		S0367		2,76 kg
DC50GSE, DC50GD	665	425	with hole	S0367		2,76 kg
DC40SE, DC50SE	665	375		S0356		3,64 kg
DC100	620	520		S0357		3,62 kg
D15, D20, D15P, D20P, D30, D30P, D40P, D50P, P15, P20, P30, P40, P50	585	380		S0358		1,90 kg
DC75SE	654	435		S0359		2,88 kg
- bottom - small DC15EP(L), DC18SP(L), DC25SP(L), DC32SP(L), DCxxGSP(L), CxxSP(L), ACxxSP(L), KCxxSP(L)	575	68		S0424		0,84 kg
D14P, D21P, D25P, P14, P21, P25	522	308		S0512		2,00 kg
D14P, D21P, D25P, P14, P21, P25 - boilers with front cover (door)	522	308		S1244		2,00 kg
D31P, P31	522	408		S0363		2,50 kg
D80P, P80	520	488		S1384		3,00 kg
D85P, P85	738	683		S1595		4,94 kg
D21	522	343		S0370		2,05 kg
DC105S, DC150S	522	635	with hole	S1190		3,97 kg
D10PX, PX10	503	350		S1362		1,88 kg
D15PX, D20PX, D25PX, PX15, PX20, PX25	544	410		S1276		2,30 kg

Table No. 7 - Rear hood for D type

Boiler type	Wide	High	Code	Price	Weight
D15, D20	565	550	S0361		3,00 kg
D15, D20, D30, D15P, D20P, D30P, D40P, D50P, P15, P20, P30, P40, P50	585	470	S0362		2,46 kg
D30	585	470	S0360		2,60 kg
D14P, D21P, D25P, P14, P21, P25	542	510	S0513		3,00 kg
D31P	582	394	S1277		2,38 kg
D80P	542	570	S1385		3,20 kg
D21	740	533	S0398		2,50 kg

Table No. 8 - Flue duct side cover

Boiler type	length x wide	Code	Price	Weight
DC15E, DC24RS, DC14R	790 x 145	S0410		1,32 kg
DC30RS	840 x 197	S0571		1,78 kg
DC18S, DC22S, DC25S, DC22SX, DC30SX, C15S, C18S, KC16S, AC25S,	790 x 175	S0431		1,56 kg
DC32S, DC40SX, DC30SE, DC15GS, DC20GS, DC25GS, DC32GS, GS15, GS20, GS25, GS32, DC18GD, DC25GD, DC30GD, DC18GSE, DC22GSE, DC30GSE, DC25GSE - since 15.4.2012	880 x 175	S0432		1,74 kg
DC40GS, GS40, C20S, C30S, C40S, AC(KC)35S, AC(KC)45S, DC25GSE - old version	1030 x 175	S0433		2,00 kg
DC40GSE, DC50GSE, DC40GD, DC50GD	1030 x 275	S0440		2,58 kg
DC50GSX, DC60GSX	1130 x 197	S0572		2,40 kg
DC50SE, DC40SE	975 x 175	S0434		2,23 kg
DC75SE	1075 x 175	S0435		2,32 kg
DC70GSX	1408 x 270	S0573		1,72 kg
DC15EP(L), DC18SP(L), DC25SP(L), C18SP(L), KC25SP(L) – from front - left	1437 x 142	S0404		2,78 kg
DC15EP(L), DC18SP(L), DC25SP(L), C18SP(L), KC25SP(L) – from front - right	790 x 142	S0405		1,56 kg
C25SP(L), AC32SP(L), KC32SP(L) – from front - right	858 x 175	S1278		1,59 kg
C25SP(L), AC32SP(L), KC32SP(L) – from front - left	1510 x 175	S1279		2,76 kg
DC32SP(L) – from front - left	1527 x 142	S0406		2,96 kg
DC32SP(L) – from front - right	895 x 142	S0407		1,70 kg
DC100	970 x 155	S0436		1,60 kg
DC105S, DC150S - left	970 x 210	S0967		2,15 kg
DC105S, DC150S - right with holes for secondary air inlet	970 x 210	S0968		2,19 kg
DCxxGSP(L) - left (short)	1489 x 148	S0408		2,57 kg
DCxxGSP(L) - right (long)	682 x 142	S0409		1,14 kg
D80P, P80 (R + L)	332 x 189	S0547		0,67 kg
D85P, P85 - flue duct cover grid (R + L)	221 x 278	S1406		0,40 kg

Table No. 9 - Frame shields of the door and combustion chamber

Boiler type	Description	Code	Price	Weight
- frame shield of the door - front DC15E, DC18S, DC22S, DC22SX, DC25S, DC30SX, DC32S, DC40SX, DC50S, DC70S, DC80, DC15GS, DC20GS, DC25GS, DC32GS, DC40GS, GS15, GS20, GS25, GS32, GS40, DC15EP(L), DC18SP(L), DC25SP(L), DC30SPX(L), DC32SP(L), DCxxGSP(L), DCxxGSE, DCxxGD, DC24RS, DC30RS,	high-level shield – L	S0441		1,74 kg
- frame shield of the door - front DC50SE	high-level thin shield – L with two noseies	S0442		3,90 kg
- frame shield of the door - front DC75SE, DC40SE	low-level thin shield – L with two noseies	S0445		3,90 kg
- combustion chamber shield - rear DC40SE, DC50SE, DC75SE,		S0449		2,27 kg
- frame shield (combustion chamber) - front C15S, C18S, KC16S, KC25S, AC25S, C18SP(L), AC25SP(L), KC25SP(L)	high-level halfround – L shield from a special material	S0443		1,28 kg
- frame shield of the door (combustion chamber) - front AC35S, KC35S, AC45S, KC45S		S1280		2,41 kg
- frame shield (combustion chamber) - front C25SP(L), AC32SP(L), KC32SP(L)	90 mm	S1281		1,31 kg
- combustion chamber shield - rear C25SP(L)	130 mm	S1282		1,88 kg
- frame shield of the door - front + combustion chamber shield - rear = identical C20S, C25ST, C30S, C32ST, C40S, C50S	high-level shield – profiled from a special material	S0444		2,84 kg
- frame shield of the door - front DC100, DC50GSX, DC60GSX, DC70GSX	L - shield	S0447		3,98 kg
- primary air inlet shield DC100		S1283		0,1 kg
- frame shield of the door - front DC100, DC105S, DC150S		S1284		2,83 kg
- combustion chamber shield - side DC105S		S1285		2,74 kg
- combustion chamber shield - side DC150S		S1286		3,75 kg
- frame shield of the door - front D15, D20, D30, D15P, D20P, D30P, D40P, D50P, D80P, P15, P20, P30, P40, P50, P80	shield with holes	S0450		1,44 kg
D21	shield with holes	S0502		1,50 kg
D14P, D21P, D25P, D31P, P14, P21, P25, P31	with holes for stainless steel shield	S0490		1,76 kg
- upper shield for D15P, D20P, D30P, D40P, D50P, P15, P20, P30, P40, P50 D15, D20, D30, D21	halfround	S0574		0,78 kg
- frame shield of the door - front D85P, P85	shield for hanging the front removable shield S1579	S1578		4,20 kg
- combustion chamber shield - side D85P, P85	L + R = identical	S1597		1,20 kg

Table No. 10 - Stove putties

Typ	Code	Price	Weight
Stove putty (Rudokit) – 1package (middle bag) – approx. 0,5 kg – used for sealing ceramic blocks by all ATMOS Combi CxxS boilers and for sealing the ceramic nozzles at the ATMOS Generators DCxxGS boilers between nozzle and wall of the boiler	S0451		0,50 kg
Stove putty (Rudokit) – one package 10 kg – for boiler CxxS Combi	V0341		10,00 kg
Stove putty - white - 1 package (big bag) - approx 1 kg – used for sealing the ceramic nozzle for all gasification boilers ATMOS	S0452		1,00 kg
Stove putty - white – full package 15 kg for boilers DCxxS (GS, GSX,GSE,SX)	V0321		15,00 kg
Stove putty in a tube – - Sticking to the sealing cord on the sides of the filling area for the type DCxxGS, DCxxGSE (GD), GSxx - 1 pack	V0345		0,66 kg

2. Wood gasification and wood burning boilers, pellet or natural gas or LFO boilers types EP(L), SP(L), GSP(L)



Ceramic roof

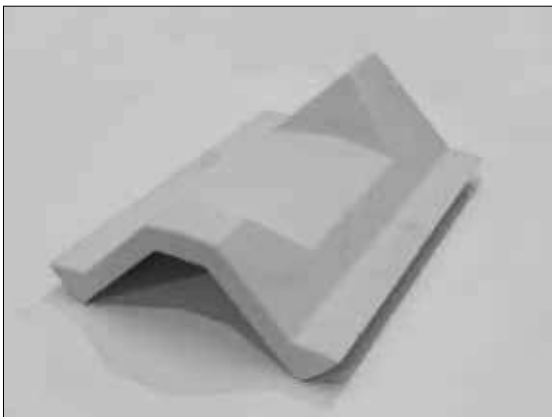

Code: DC0042 new version for boilers: DC18S, DC18SP(L) length – 320 mm DC15E from serial number 310488	<i>Price:</i> <i>Weight:</i> 8,22 kg
Code: DC0043 new version for boilers: DC22S, DC25S, DC30SE, DC40SE, (DC75SE-(2pcs)), DC32S, DC25SP(L), DC32SP(L), DC22SX – DC40SX – length = 500 mm	<i>Price:</i> <i>Weight:</i> 12,08 kg
Code: DC0044 new version for boilers: DC50S, DC50SE, (DC50) - length = 700 mm	<i>Price:</i> <i>Weight:</i> 16,62 kg

Half moon - ceramic door shield for spherical chamber



Code: DC0021 for all types of boilers ATMOS DCxxGS / GSE / GD / GSX, GSxx, GSXxx, DCxxGSP(L), DC18S, DC100, all types ATMOS Kombi CxxS(T), ACxxS, KCxxS, DCxxR(S), DCxxSP(L), CxxSP(L), AC/KCxxSP(L)	<i>Price:</i> <i>Weight:</i> 4,50 kg
Code: DC0193 for DC105S, DC150S	<i>Price:</i> <i>Weight:</i> 7,44 kg

B) The rear end of the 4-piece spherical space



Code: DC0091 the rear end for boilers: C15S, C18S, DC18S, DC15GS, DC20GS, DC25GS, DC32GS, DC40GS, (DC50S), DC30SE, DC18GSE - DC50GSE, DCxxR(S), KC16S, AC25S, KC25S, DC50GSX, DC60GSX, DCxxGD middle chamber for boilers - DCxxSP(L), DCxxGSP(L), CxxSP(L), ACxxSP(L), KCxxSP(L)	<i>Price:</i> <i>Weight:</i> 7,48 kg
Code: C0041 the rear end of the spherical chamber DC70GSX, GSX70	<i>Price:</i> <i>Weight:</i> 10,18 kg
Code: DC0168 the rear end of the spherical chamber only for DC100 - with taller nose	<i>Price:</i> <i>Weight:</i> 10,58 kg

A) 4-piece spherical chamber L+R



Table No. 12 on page 49

Nozzle



Table No. 11 on page 48

The nozzle is supplied always with stove putty and with along laid sealing cords (3 pcs of sealing cords)

Side of combustion chamber - for GS, GSE, GD, GSP(L)

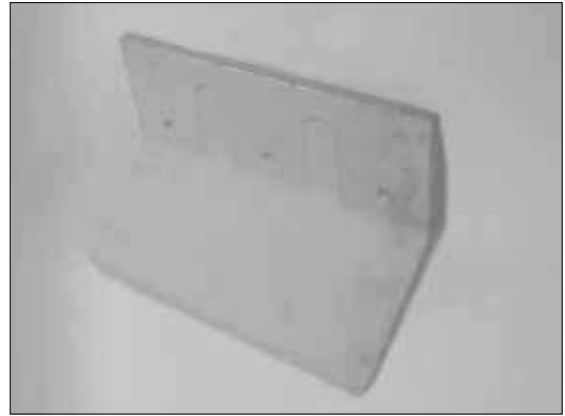

Table No. 13 on page 51

Ceramic block - nozzle prolongation



Code: DC0031 ceramic block for boilers DC50S, DC50SE, DC70S, DC80, DC150S DC70GSX (chamber 800 mm)	<i>Price:</i>
	<i>Weight:</i> 8,90 kg
Code: S1287 sealing cord for the cube 2x - 18x18x190, 1x - 12x14x190	<i>Price:</i>
	<i>Weight:</i> 0,14 kg
Code: DC0129 ceramic block for boilers DC75SE	<i>Price:</i>
	<i>Weight:</i> 13,80 kg
Code: S0948 sealing cord for cube (DC0129) 2x - 14x14x1090, 2x - 14x14x190	<i>Price:</i>
	<i>Weight:</i> 0,38 kg

A) Spherical chamber 5-pcs– Left + Right



Code: DC0011 spherical chamber L+R side - the oldest version for boiler types DC25G, DC32G, DC40G, manufacture year 1992-96, for boilers with cast iron frame in the door (twoparts left + twoparts right side + ceramic half moon)	<i>Price:</i>
	<i>Weight:</i> 37,00 kg

Sibral strip - spherical chamber cealing - 42 cm



Code: S0453 1 pc - for sealing gap between ceramic spherical chamber and nozzle holder – for boilers DC18S, DCxxGS, DCxxSP(L), DC30SE, DCxxGSE, DCxxGSX, DC22SX, DCxxGD, DCxxGSP(L), C15S, KCxxS, KCxxSP (2 pcs necessary for boiler)	<i>Price:</i>
	<i>Weight:</i> 0,10 kg

Spherical chamber 3-pcs– L+R



DIFFERENT DIAMETER - not substituble from new boilers	
Code: DC0061 old version for boiler types DC25G(S), DC32G(S), DC40G(S) – left + right side	<i>Price:</i>
	<i>Weight:</i> 34,44 kg
Code: DC0062 old version for boilers DC18 – smaller form (L+R sides can be used in older boilers DC18 with ceramic roof)	<i>Price:</i>
	<i>Weight:</i> 19,60 kg

B) Divided spherical space 5 - pcs L+R



Code: DC0012 front ceramic parts of the chamber, right and left side = identical

<i>Price:</i>
<i>Weight:</i> 4,30 kg

Ceramic triangle part

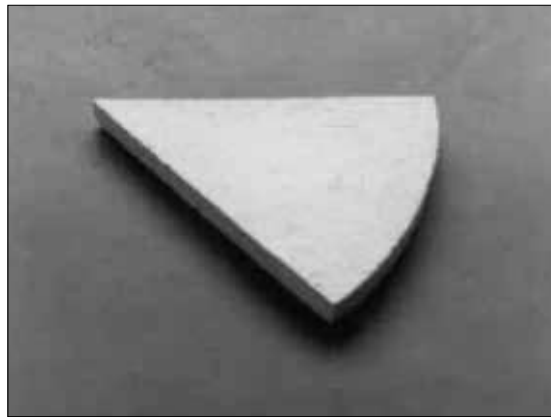

Code: DC0051 old version for boilers: DC25S, DC32S (DC25, DC32) triangle with marks (2)

<i>Price:</i>
<i>Weight:</i> 1,14 kg

Code: DC0052 old version for boilers: DC50S (DC50). Old version – DC32 (the frame of the lower door is not made from one piece of sheet plate) - triangle with marks (1).

<i>Price:</i>
<i>Weight:</i> 1,22 kg

Half moon ceramic shaped part – DCxxG



Code: DC0071 for types DC25G(S), DC32G(S), DC40G(S) – old version (dimensionally bigger then for DC18(S))

<i>Price:</i>
<i>Weight:</i> 1,24 kg

Half moon ceramic part – into DC70S

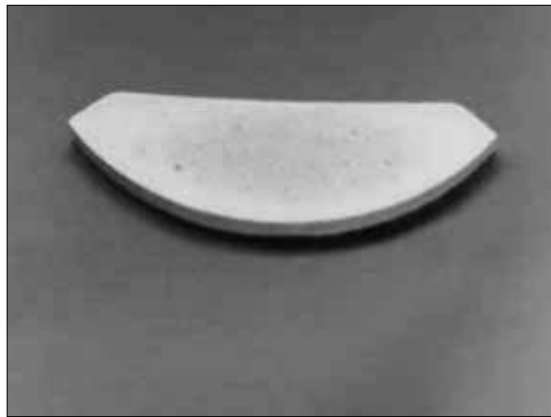

Code: DC0111 half moon DC70S, DC80

<i>Price:</i>
<i>Weight:</i> 2,44 kg

Half moon ceramic shaped part – DC18



Code: DC0101 for types DC18(S) – old version

<i>Price:</i>
<i>Weight:</i> 1,58 kg

Combustion chamber board for DC80 and DC70S

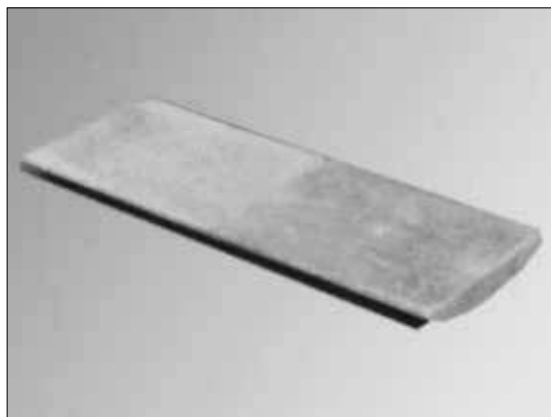

Code: DC0151 consists of 2 pcs (2x DC0152)

<i>Price:</i>
<i>Weight:</i> 10,90 kg

Combustion chamber sid DCxxGSX

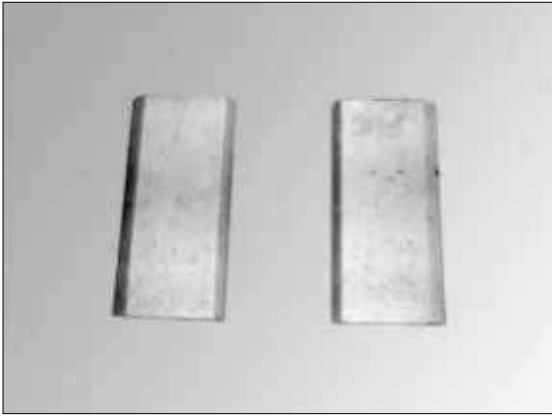

Code: DC0183 for DC50GSX, DC60GSX, DC70GSX (chamber 600 mm) – (consists of 4 pcs DC0181)	<i>Price:</i>
	<i>Weight:</i> 10,60 kg
Code: DC0211 1 pc - side parts of the gasification chamber DC70GSX (chamber 800 mm) - 6 pcs for boiler	<i>Price:</i>
	<i>Weight:</i> 3,49 kg

Combustion chamber lining DC15E (DC18S), DC15EP(L)

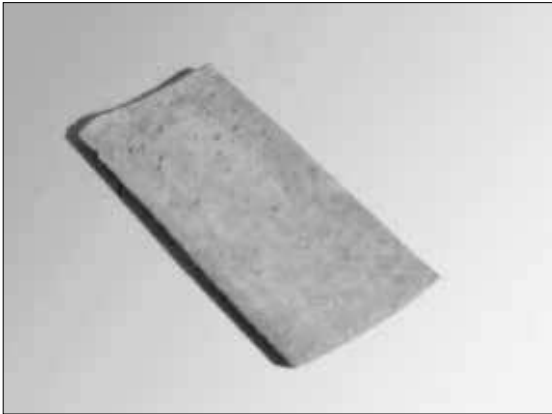

Code: DC0141 2 pcs for one boiler (2x DC0142) - placed along the nozzle	<i>Price:</i>
	<i>Weight:</i> 6,22 kg

Bottom part of combustion chamber DC15E, DC15EP(L)

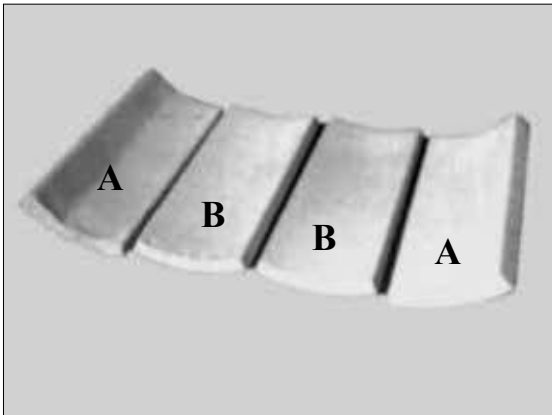

Consists – 2 pcs - outer part A; 2 pcs – middle part B	
Code: DC0118 A - outer part – 2 pcs (2x DC0114)	<i>Price:</i>
	<i>Weight:</i> 7,90 kg
Code: DC0115 B - middle part – 2 pcs (2x DC0116)	<i>Price:</i>
	<i>Weight:</i> 8,30 kg
Code: DC0184 complet (DC0118 + DC0115) - 4 pcs	<i>Price:</i>
	<i>Weight:</i> 16,20 kg

Combustion chamber dome (arch)

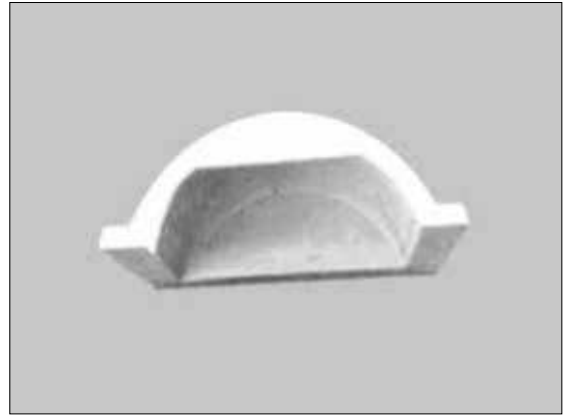

Code: D0011 small - D15, P15, P20, D15P, D20P, DC15E, DC15EPL, DC18SPL, DC18GSPL, CxxSPL, ACxxSPL, KCxxSPL	<i>Price:</i>
	<i>Weight:</i> 10,96 kg
Code: D0015 big (470 mm) - for D20, D30, DC25SPL, DC32SPL, DC25/30GSPL, D30P, D40P, P30, P40, rear for D80P, P80	<i>Price:</i>
	<i>Weight:</i> 17,28 kg
Code: D0045 small with prolonging for D50P (D45P), P50 (D0011+D0044)	<i>Price:</i>
	<i>Weight:</i> 30,14 kg
Code: D0053 D80P, P80 - front - 420 mm	<i>Price:</i>
	<i>Weight:</i> 14,45 kg

Rear board of the combustion chamber



Code: D0021 for boilers D15, D20, D30 D15P, D20P, D30P, D40P, D50P (D45P), P15, P20, P30, P40, P50, D21	<i>Price:</i>
	<i>Weight:</i> 10,98 kg

Bottom of the combustion chamber – old version



Code: D0031 for boiler D15 - consists of two pieces - old version of boilers (2x D0032)	<i>Price:</i>
	<i>Weight:</i> 6,50 kg
Code: D0033 for boilers D20, D30 - 1 pcs	<i>Price:</i>
	<i>Weight:</i> 8,50 kg

Combustion space - bottom - for D80P, P80

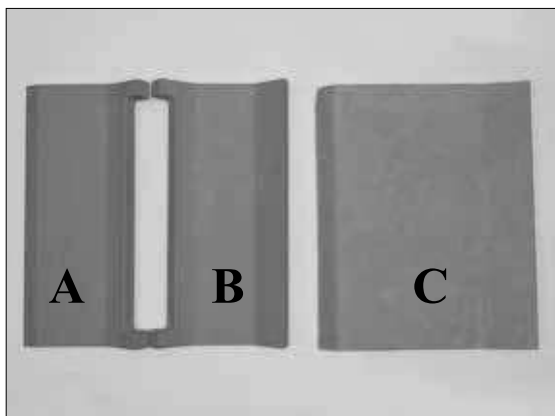

Code: D0040 bottom of the combustion space - complet - for D80P, P80 2x D0050 + 2x D0051 + 1x D0052	<i>Price:</i>
	<i>Weight:</i> 45,68 kg
Code: D0051 A - bottom of the combustion space - for D80P, P80	<i>Price:</i>
	<i>Weight:</i> 6,00 kg
Code: D0050 B - bottom of the combustion space - with nose for plate - for D80P, P80	<i>Price:</i>
	<i>Weight:</i> 8,14 kg
Code: D0052 C - plate (side) of combustion space - D80P, P80	<i>Price:</i>
	<i>Weight:</i> 17,40 kg

Bottom of the combustion chamber D15P, D20P, D30P, D40P, D50P – new

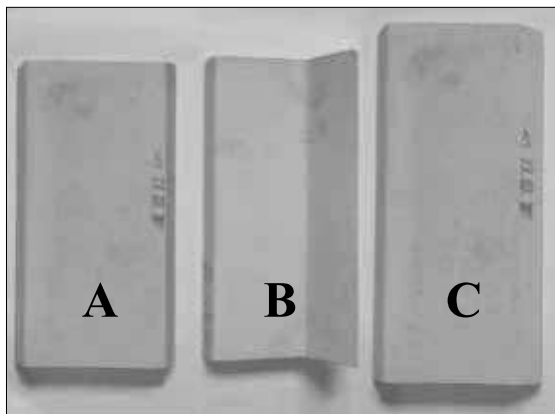

Code: D0034 A - for D15P, D20P, P15, P20 - side part without channel for side plate	<i>Price:</i>
	<i>Weight:</i> 5,60 kg
Code: D0035 B - for D15P, D20P, P15, P20 - side part with channel for side plate	<i>Price:</i>
	<i>Weight:</i> 3,80 kg
Code: D0036 C - side plate of burning chamber D15P, D20P, P15, P20 put on side part with channel D0035	<i>Price:</i>
	<i>Weight:</i> 5,20 kg
Code: D0037 A - for D30P, D40P, P30, P40 - side part without channel for side plate (2 pcs.)	<i>Price:</i>
	<i>Weight:</i> 2,24 kg
Code: D0048 B - for D30P, D40P, P30, P40 - side part with channel for side plate (2 pcs.)	<i>Price:</i>
	<i>Weight:</i> 4,80 kg
Code: D0043 A - for D50P (D45P), P50 - side part without channel for side plate (2 pcs.)	<i>Price:</i>
	<i>Weight:</i> 3,38 kg
Code: D0046 B - for D50P (D45P), P50 - side part with channel for side plate (2 pcs.)	<i>Price:</i>
	<i>Weight:</i> 4,76 kg
Code: D0047 C - side plate of the burning chamber for D30P, D40P, D50P (D45P), P30, P40, P50 to be put on side part with channel D0046/48	<i>Price:</i>
	<i>Weight:</i> 5,90 kg

Bottom of the combustion chamber D15, D20, D21, D30 - new version

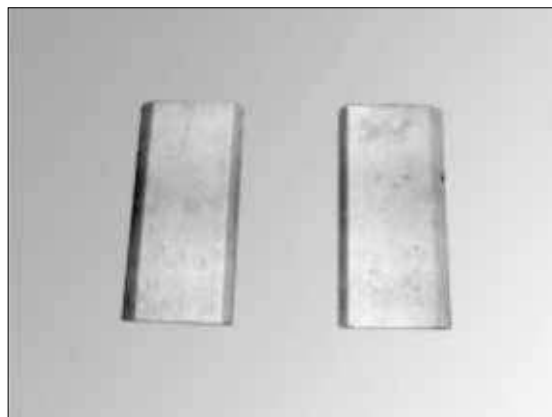

Code: D0039 for boilers D15 – consists of two pieces – new version (2x D0034)	<i>Price:</i>
	<i>Weight:</i> 6,10 kg
Code: D0038 for boilers D20, D30, D21 – consists of four pieces – new version (4x D0037)	<i>Price:</i>
	<i>Weight:</i> 10,30 kg

Parts for grating for D15P - D50P, P15 - P50

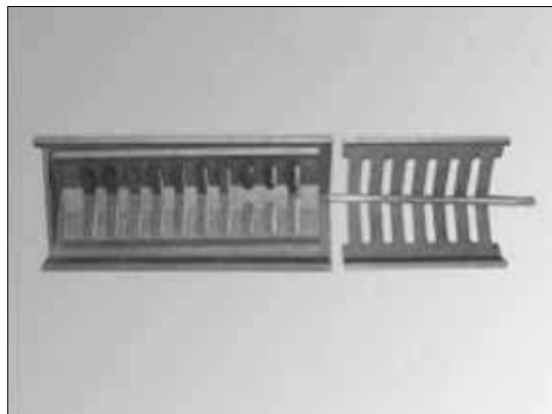

Code: C0006 lower grate - fixed. For boilers D15, D15P, D20P, D30P, D40P, D50P (D45P)	<i>Price:</i>
	<i>Weight:</i> 3,12 kg
Code: C0007 upper grate - moveable. For boilers D15, D15P, D20P, D30P, D40P, D50P (D45P)	<i>Price:</i>
	<i>Weight:</i> 1,80 kg
Code: C0002 grate accessory for D50P (D45P), P50	<i>Price:</i>
	<i>Weight:</i> 0,48 kg
Code: C0003 grate complete without pull rod – for boilers D15, D15P, D20P – consists of (1x C0006 + 1x C0007)	<i>Price:</i>
	<i>Weight:</i> 5,00 kg
Code: V0654 extension of the lower fixed grate - for type D21, D20, D30 D30P, D40P, P30, P40,	<i>Price:</i>
	<i>Weight:</i> 1,54 kg
Code: C0005 grate complete without pull rod – for boilers D20, D21, D30, D30P, D40P, P30, P40 – consists of (1x C0006, C0007 and 1x V0654)	<i>Price:</i>
	<i>Weight:</i> 6,54 kg
Code: C0004 grate complete without pull rod - for boilers D50P (D45P), P50 (consists of 2x C0006, 2x C0007, C0002)	<i>Price:</i>
	<i>Weight:</i> 9,80 kg
Code: V0510 tow bar D15, D15P, D20P, P15, P20	<i>Price:</i>
	<i>Weight:</i> 0,12 kg
Code: V0511 tow bar D20, D30, D30P, D40P, P30, P40	<i>Price:</i>
	<i>Weight:</i> 0,26 kg
Code: V0513 tow bar D50P (D45P), P50	<i>Price:</i>
	<i>Weight:</i> 0,38 kg
Code: V0527 tow bar D21	<i>Price:</i>
	<i>Weight:</i> 0,28 kg

Types and number of sealing cords for sealing ceramics – depend on boiler type

Boiler type	Name	Pcs	Dimension	Code	Price	Weight
AC25S, AC35S, DC14R, DC24RS, DC30RS, C15S, C18S, C20S, C25ST, C30S, C32ST, C40S, C50S	Insulating cord - furnace grate pipe	1 1	18x18x275 22x22x275	S0940		0,16 kg
D15, D20, D21, D30, D15P, D20P, D30P, D40P, D50P (D45P), P15, P20, P30, P40, P50	Insulating cord - combustion chamber - rear board	2 2 2	14x14x280 18x18x280 8x8x190	S0941		0,38 kg
DC15GS	Insulating cord - Nozzle	1 2	12x14x190 14x14x285	S1367		0,12 kg
DC15E, DC15EP(L)	Insulating cord - Nozzle	2 1 2	12x14x385 12x14x190 12x12x190	S0942		0,37 kg
DC18S, DC22SX, DC18SP(L) DC20GS, DC18GD, DC18GSE, DC20GSE	Insulating cord - Nozzle	2 1	12x14x385 12x14x190	S0943		0,29 kg
DC22S, DC25S, DC30SX, DC32S, DC40SX, DC25GS, DC32GS, DC40GS, DC25GD, DC30GD, DC40GD, DC50GD, DC25GSE, DC30GSE, DC40GSE, DC50GSE DC25SP(L), DC30SPX(L), DC32SP(L)	Insulating cord - Nozzle	2 1	12x14x590 12x14x190	S0944		0,28 kg
DC50S	Insulating cord - Nozzle	2 2 1 1	12x14x590 18x18x190 12x14x190 10x10x190	S0945		0,39 kg
DC80, DC70S, DC70GSX (chamber 800 mm)	Insulating cord - Nozzle	2 3 1	12x14x590 18x18x190 12x14x190	S0946		0,42 kg
DC40SE	Insulating cord - Nozzle	2 1	12x14x590 12x14x190	S0947		0,26 kg
DC50GSX, DC60GSX, DC70GSX (chamber 600 mm), GSX50, GSX60, GSX70 (chamber 600 mm)	Insulating cord - Nozzle	2 3	12x14x590 12x14x190	S0954		0,51 kg
DC75SE	Insulating cord - Nozzle	2 2	14x14x1090 14x14x190	S0948		0,38 kg
DC105S	Insulating cord - Nozzle	2 1	14x16x590 12x14x190	S0969		0,31 kg
DC100, DC150S	Insulating cord - Nozzle	2 1 1	18x18x780 18x18x190 14x14x190	S0949		0,40 kg
DC15GS	Insulating cord - combustion chamber	4	14x14x285	S1368		0,18 kg
DC20GS, GS20, DC18GSE, DC22GSE (GD), DC18GD	Insulating cord - combustion chamber	2 2 2 1	12x14x385 12x12x385 10x10x285 12x14x190	S0950		0,37 kg
DC25GS, DC32GS, GS25, GS32, DC30GSE, DC30GD, DC25GD DC25GSE - od 15.4.2012 DC25GSP(L), DC32GP(L)	Insulating cord - combustion chamber	2 2 2 1	12x14x590 12x12x590 10x10x285 12x14x190	S0951		0,42 kg
DC25GSE - old version	Insulating cord - combustion chamber	2 2 1 2	12x14x385 18x18x385 10x10x190 10x10x430	S0952		0,40 kg
DC40GS, GS40, DC40GSE, DC40GD, DC50GSE, DC50GD	Insulating cord - combustion chamber	4 2 1	12x14x590 10x10x430 12x14x190	S0953		0,45 kg
DC50S, DC50SE, DC70S, DC80, DC150S, DC70GSX, GSX70 (chamber 800 mm)	Cube sealing cord - nozzle prolongation	2 1	18x18x190 12x14x190	S1287		0,14 kg
DC75SE	Cube sealing cord - nozzle prolongation	2 2	14x14x1090 14x14x190	S0948		0,38 kg
D10PX, D15PX, D20PX, D25PX, PX10, PX15, PX20, PX25	Sealing for combustion chamber shield	1	14x14x300	S1215		0,04 kg

Table No. 11 - Ceramic nozzles

Boiler type	A	B	C	D	E	F	Mark	Code	Price	Weight	
DC15E, DC15EP(L)	180	40	390	190	140	186		DC0120		11,80 kg	
DC15GS, GS15	120	34	298	200	110	152		DC0123		9,14 kg	
DC18S since 1.1.2019	110	38	390	190	120	150	⊕	DC0149		10,30 kg	
DC18S, DC22SX, DC20GS, GS20, DC18GSE, DC22GSE, DC18GD DC25GSE - old version DC18SP(L), DC18GSP(L)	140	34	390	190	110	175		DC0121		12,60 kg	
DC18	180	35 (34)	390	190	80	230		DC0122		12,10 kg	
DC25G, DC22, DC25, DC22S, DC25S, DC30SX, DC30SF DC25SP(L), DC30SPX(L)	200	34	590	190	110	232	△	DC0125		16,60 kg	
DC25GS, GS25, DC30SE, DC30GSE, DC30GD DC32GS, GS32, DC35SF, DC30GSP(L)	200	34	590	200	110	232	△△	DC0180		16,90 kg	
DC32G(S), DC32, DC32S, DC40SX DC40GS, GS40 - since 1.6.2018 DC32SP(L), DC35 Swedish (DC40G)	240	34	590	200	110	285	OOO	DC0131		17,00 kg	
DC40G, DC40GSE, DC50GSE, DC40GS, GS40 - until 31.5.2018 DC40GD, DC50GD DC50GSX, GSX50	285	34	590	200	100	315	OO	DC0132		16,90 kg	
DC25GSE since 15.4.2012 DC25GD DC25GSP(L)	140	34	590	200	110	175	O	DC0126		16,90 kg	
DC40SE, DC60GSX, GSX60, DC70GSX, GSX70 (chamber 600 mm) DC50S – for boilers since 31.3.2018	280	45	588	200	116	312	□□□	DC0140		17,80 kg	
Nozzle DC50S for boilers since 1.4.2018 (from serial number 348284)	230	45	590 + cube	200	116	262	O□	DC0148		17,70 kg	
DC100 – complete	230 + 240	38	392x2	200	85	61		DC0135		21,20 kg	
DC105S	320	50	583	200	110	352		DC0200		14,26 kg	
DC150S	360	50	582	200	110	392		DC0192		14,46 kg	
Nozzle DC50, DC50S for boilers since 31.12.09	300	35	590 +cube	200			□	DC0133		17,90 kg	
Nozzle DC80, DC70S, DC70GSX (chamber 800 mm)	310	35	590 +cube	200	90	370	□	DC0134		17,20 kg	
Nozzle DC50SE, DC75SE	300	50	582	200	90	332	△□	DC0130		16,30 kg	
Cube DC50S, DC80, DC70S, DC50SE, DC150S, DC70GSX (chamber 800 mm)	-	-	200	200	-	-	-	DC0031		8,90 kg	
Cube DC75SE	-	-	500	200	-	-	△□	DC0129		15,30 kg	
Nozzle + cube DC75SE	DC0130 + DC0129								DC0179		31,60 kg

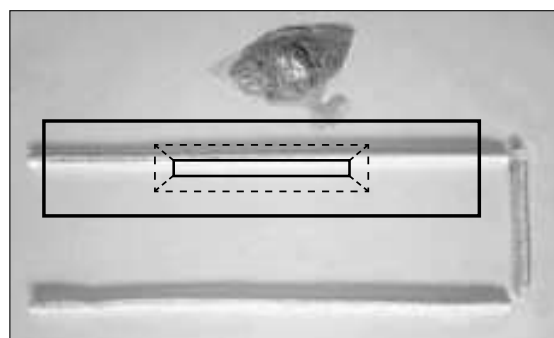
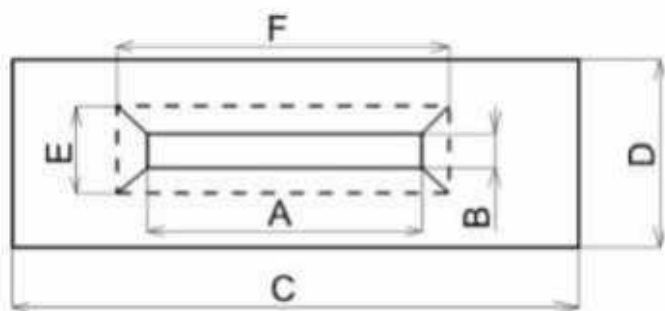

Putty and sealing cords of insulation along nozzle (different types on boiler type) – supplied with nozzle (3 pcs)

Table No. 12 - 4-piece spherical chamber L+R

Boiler type	Depth of spherical chamber	Code spherical chamber complete – left + right side + rear face	Price	Weight	Code spherical chamber only left + right side	Price	Weight
DC15GS, GS15, (C15S, KC16S)	210 mm low profile	C0048		16,34 kg	C0049		9,66 kg
		consist of: C0075 + C0076 + DC0091			consist of: C0075 + C0076		
DC18S, DC20GS, DC18GSE, DC18GD, DC22GSE, GS20, DC25GSE - old version middle chamber for boilers DC18SP(L), DC18GSP(L)	310 mm	DC0081		23,14 kg	DC0085		16,42 kg
		consist of: DC0095 + DC0096 + DC0091			consist of: DC0095 + DC0096		
DC25GS, GS25, DC25GD, DC25GSE od 15.4.2012 DC30GSE, DC30GD, DC30SE, DC32GS, GS32, DC40GS, GS40, DC40GSE, DC40GD, DC50GSE, DC50GD, DC50GSX, GSX50 DC60GSX, GSX60 middle chamber for boilers DC25SP(L), DC30SPX(L), DC32SP(L), DC25GSP(L), DC30GSP(L)	510 mm	DC0082		43,70 kg	DC0086		36,64 kg
		consist of: DC0093 + DC0094 + DC0091			consist of: DC0093 + DC0094		
DC50SE – old version (including prolongation)	510 mm + 200 mm	DC0087		56,92 kg	DC0088		49,88 kg
		consist of: DC0093 + DC0094 + 2x DC0097 + DC0091			consist of: DC0093 + DC0094 + 2x DC0097		
Prolonging of the spherical chamber for DC50SE (DC50S) – 200 mm – old version					DC0089		13,22 kg
					2x DC0097		
CAUTION – the spherical chamber for boilers DC100, DC70GSX, GSX70 is shown on pages 57. Table No.16							
CAUTION – the spherical chamber for burning pellets for boilers DCxxSP, CxxSP, AC/KCxxSP is shown on pages 56. Table No.16							

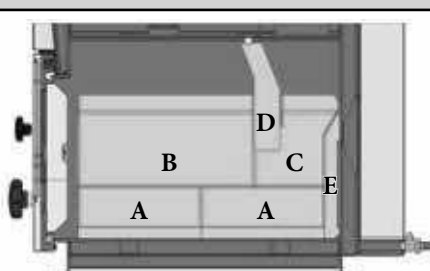
Burning chamber ceramic for boilers D10PX, PX10	Type	Pieces per boiler	Code	Price	Weight
	A	4	DC0216		2,69 kg
	B	2	DC0212		3,68 kg
	C - left	1	DC0213		1,39 kg
	C - right	1	DC0214		1,39 kg
	D	1	DC0207		9,02 kg
	E	1	DC0217		4,76 kg

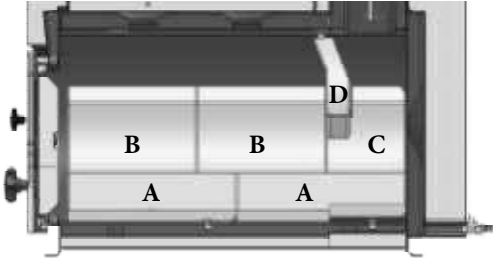
Burning chamber ceramic for boilers D15PX, D20PX, PX15, PX20		Type	Pieces per boiler	Code	Price	Weight
	A	4	DC0202		4,06kg	
	B	4	DC0205		3,00 kg	
	C - left	1	DC0203		1,64 kg	
	C - right	1	DC0204		1,64 kg	
	D - D15XP/PX15	1	DC0207		9,02 kg	
	D - D20XP/PX20	1	DC0206		7,48 kg	

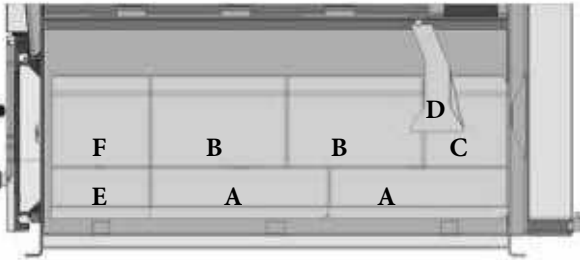
Burning chamber ceramic for boilers D25PX, PX25		Type	Pieces per boiler	Code	Price	Weight
	A	4	DC0202		4,06kg	
	B	4	DC0205		2,92 kg	
	C - left	1	DC0203		1,64 kg	
	C - right	1	DC0204		1,64 kg	
	D	1	DC0210		10,52 kg	
	E	2	DC0208		2,20 kg	
	F	2	DC0209		2,10 kg	

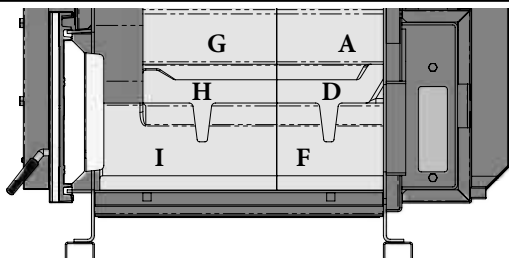
Burning chamber ceramic for boilers DC105S		Type	Pieces per boiler	Code	Price	Weight
	A	2	DC0191		2,78 kg	
	G	2	DC0199		3,46 kg	
	D	1	DC0188		14,44 kg	
	H	1	DC0198		17,80 kg	
	F	2	DC0185		4,68 kg	
	I - left	1	DC0196		7,74 kg	
	I - right	1	DC0197		7,74 kg	

Burning chamber ceramic for boilers DC150S		Type	Pieces per boiler	Code	Price	Weight
	A	6	DC0191		2,78 kg	
	B	1	DC0190		14,40 kg	
	C	1	DC0189		13,78 kg	
	D	1	DC0188		14,44 kg	
	E - left	1	DC0187		7,36 kg	
	E - right	1	DC0186		7,36 kg	
	F	4	DC0185		4,68 kg	

Table No. 13 - Side parts of the gasification chamber – for boilers DCxxGS, GSxx, DCxxGSE, DCxxGD, DCxxGSP(L)

Boiler type	Lenght	Amount of holes in the part	Amount of pieces	Code	Price	Weight
DC15GS, GS15	292	2 + 2	2	DC0311		13,50 kg
				consist of: 2x DC0173		
DC18GSE DC18GD DC22GSE, (GD) - since 1.1.2017 (from s. n.. 332868) DC20GS - since 1.1.2017 GS20 - since 1.1.2017	392	3 + 2	2	DC0176		13,90 kg
				consist of: 2x DC0175		
DC22GSE, (GD) - until 31.12.2016 DC20GS - since 31.12.2016 GS20 - since 31.12.2016	392	3	2	DC0161		13,50 kg
				consist of: 2x DC0166		
DC25GSE - old version (chamber 400 mm)	392	4	2	DC0177		24,20 kg
				consist of: 2x DC0178		
DC25GSE - until 15.4.2012 (new version) (chamber 600 mm) DC25GD DC25GSP(L) DC25GS, GS25 - since 1.1.2017	292	2 + 2	4	DC0174		27,00 kg
				consist of: 4x DC0173		
DC25GS, GS25 - since 31.12.2016 DC30GSE DC30GD DC30GSP(L) DC32GS, GS32	292	3	4	DC0162		25,00 kg
				consist of: 4x DC0165		
DC40GSE, DC50GSE DC40GD, DC50GD DC40GS GS40	292	4	4	DC0163		37,20 kg
				consist of: 4x DC0167		

3. Gasification boilers for coal and wood CxxS(T), lignite briquets ACxxS and wooden briquets DCxxRS

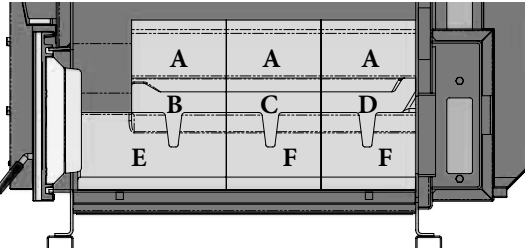

A) Spherical ceramic chamber 4-pcs Combi L+R



Table No. 16 on page 56 - 57

Half moon - ceramic door screen for spherical chamber



Code: DC0021 for all boilers type
ATMOS Combi CxxS(T), ACxxS,
KCxxS, CxxSP(L), ACxxSP(L), KCxxSP(L)

Price:
Weight: 4,50 kg

Rear face of the 4pcs spherical chamber – Kombi

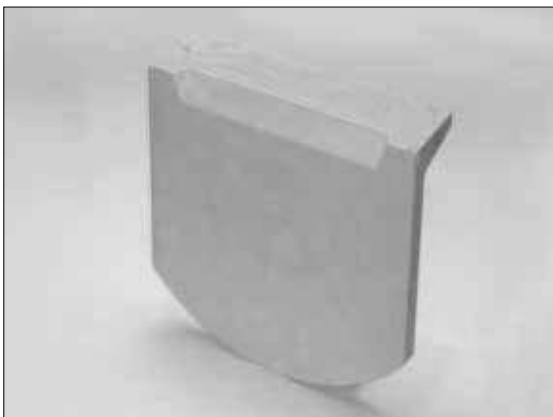

Code: C0041 rear end of the spherical chamber C20(S), C30(S), C40(S), C50S C25ST, C32ST, AC35S, AC45S, KC35S, KC45S, DC70GSX into bottom chamber for burning pellets - DC15EP, DCxxSP, CxxSP, ACxxSP, KCxxSP, DCxxGSP

Price:
Weight: 10,18 kg

Code: DC0091 rear end of the spherical chamber C15S, C18S, DC15GS, GS15, AC25S, KC16S, KC25S, middle chamber - DCxxSP(L), DCxxGSP(L), CxxSP(L), KCxxSP(L)

Price:
Weight: 7,48 kg

Code: DC0168 rear end of the spherical chamber only for DC100 - with taller nose

Price:
Weight: 10,58 kg

Grate ceramic block - CxxS(T), ACxxS, KCxxS



Table No. 15 on page 55

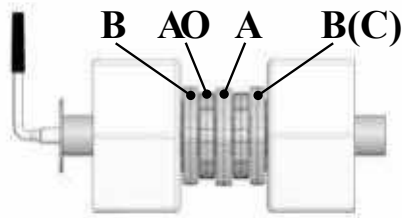

Grate - until 8/2016

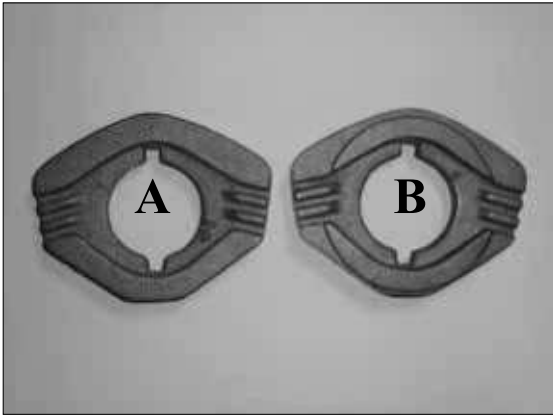

width of the Grate - 158 mm

Code: C0028 A) type - for all boilers ATMOS Combi – thick 24 mm – standard - except C40S, C50S - new version	<i>Price:</i>
	<i>Weight: 1,30 kg</i>
Code: C0029 A) type - for all boilers ATMOS Combi – thin 20 mm – as an extra option - except C40S, C50S - new version	<i>Price:</i>
	<i>Weight: 1,12 kg</i>
Code: C0027 B) type - first and last one, for all boilers ATMOS Kombi - grate with fitting - except C40S, C50S - new version	<i>Price:</i>
	<i>Weight: 1,42 kg</i>

Grate → standard (middle) – A) / first – B) / last one – C) OLD VERSION

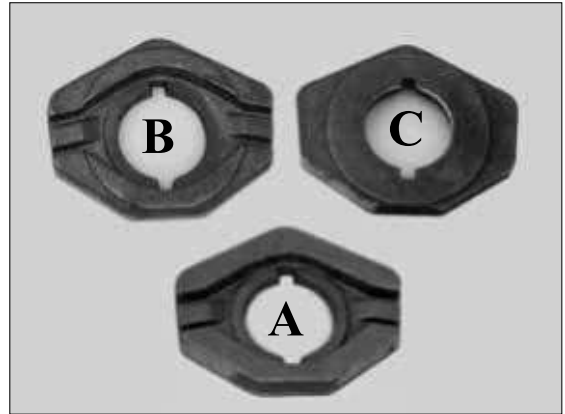

width of the Grate - 159 mm

Code: C0016 A) type - for all boilers ATMOS Combi – thick 24 mm – standard - except C40S, C50S - old version	<i>Price:</i>
	<i>Weight: 1,54 kg</i>
Code: C0019 A) type - for all boilers ATMOS Combi – thin 20 mm – as an extra option - except C40S, C50S - old version	<i>Price:</i>
	<i>Weight: 1,20 kg</i>
Code: C0017 B) type - first, for all boilers ATMOS Combi except C40S, C50S - old version	<i>Price:</i>
	<i>Weight: 1,44 kg</i>
Code: C0018 C) type - last one, for all boilers ATMOS Kombi - except C40S, C50S - old version	<i>Price:</i>
	<i>Weight: 1,44 kg</i>

Grate - New - with chromium (Cr)

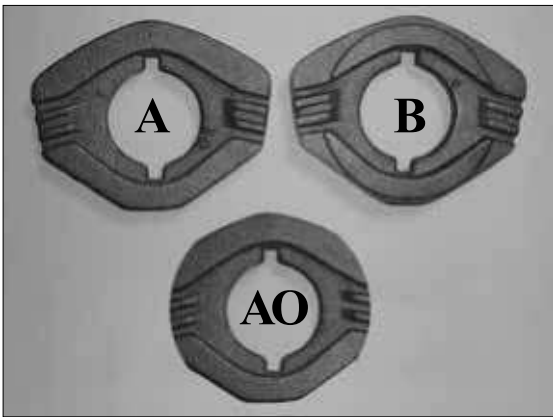

width of the Grate - A a B - 148 mm / AO - 130 mm

Code: C0008 A) type - for all boilers ACxxS, KCxxS, C18S, C25ST, C32ST, C40S, C50S – thick 24 mm – with Cr	<i>Price:</i>
	<i>Weight: 1,30 kg</i>
Code: C0009 A) type - for all boilers ACxxS, KCxxS, C18S, C25ST, C32ST, C40S, C50S – thin 20 mm – as an extra option – with Cr	<i>Price:</i>
	<i>Weight: 1,12 kg</i>
Code: C0083 AO) round type - for boilers C18S - since 2016, C25ST, C32ST – thick 24 mm – with Cr since 8/2016	<i>Price:</i>
	<i>Weight: 1,26 kg</i>
Code: C0084 AO) round type - for boilers C18S - since 2016, C25ST, C32ST – thin 20 mm – as an extra option – with Cr since 8/2016	<i>Price:</i>
	<i>Weight: 1,06 kg</i>
Code: C0010 B) type - for all boilers ACxxS, KCxxS, C15S, C18S, C25ST, C32ST, C40S, C50S – grate with fitting – first and last one – with Cr	<i>Price:</i>
	<i>Weight: 1,42 kg</i>

Cast iron grate – DCxxR (S)



DC14R	4x - C0066	
DC24RS, DC30RS	3x - C0066	
Code: C0066 for boilers DC14R, DC24RS, DC30RS	<i>Price:</i>	
	<i>Weight: 1,54 kg</i>	

Grate pipe



Table No. 14 on page 55

Grate bar with handle



Code: S0227 grate bar with handle for CxxS(T), ACxxS, KCxxS - 200 mm	<i>Price:</i>
	<i>Weight: 0,35 kg</i>
Code: S0228 grate bar with handle for DCxxRS - 180 mm	<i>Price:</i>
	<i>Weight: 0,31 kg</i>

Grate bar sealing cord



Code: S0940 1x - 18x18x275	<i>Price:</i>
1x - 22x22x275	<i>Weight: 0,16 kg</i>

Combustion chamber ceramic parts – DCxxR(S)

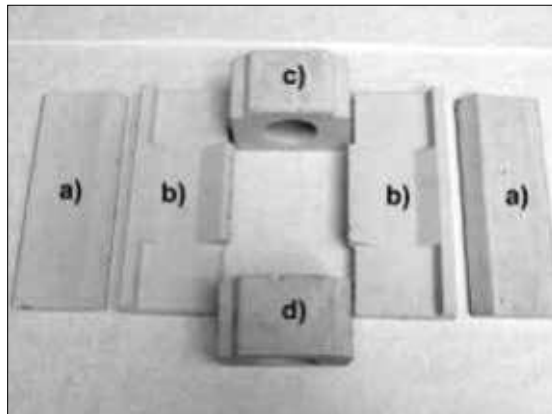

Code: DC0019 c,d,) ceramic block for DC14R (front and rear side) – 1 pc	<i>Price:</i>
	<i>Weight: 5,86 kg</i>
Code: DC0154 b) ceramic side of the grate DC14R - 1 pc	<i>Price:</i>
	<i>Weight: 5,80 kg</i>
Code: DC0144 a) insertion of the burning chamber – halfmoon – 1 pc - DC14R	<i>Price:</i>
	<i>Weight: 3,32 kg</i>
Code: DC0019 c) ceramic block for DC24RS, DC30RS (rear one) – 1 pc	<i>Price:</i>
	<i>Weight: 5,86 kg</i>
Code: DC0020 d) ceramic block for DC24RS, DC30RS (front) –1 pc	<i>Price:</i>
	<i>Weight: 7,60 kg</i>
Code: DC0156 b) ceramic side of the grate - left – 1 pc	<i>Price:</i>
	<i>Weight: 5,80 kg</i>
Code: DC0157 b) ceramic side of the grate - right – 1pc - DC24RS, DC30RS	<i>Price:</i>
	<i>Weight: 5,80 kg</i>
Code: DC0146 a) insertion of burning chamber - halfmoon - 1 pc - DC24RS, DC30RS	<i>Price:</i>
	<i>Weight: 3,50 kg</i>
Code: DC0155 b) ceramic side of the grate - (left+right) – 2 pcs - 2x DC0154 - DC14R	<i>Price:</i>
	<i>Weight: 11,60 kg</i>
Code: DC0145 a) insertion of burning chamber - halfmoon - 2 pcs - 2x DC0144 - DC14R	<i>Price:</i>
	<i>Weight: 6,64 kg</i>

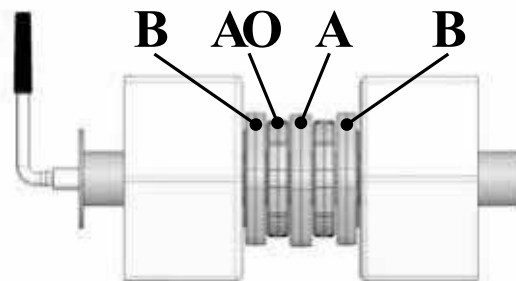

Grates - boiler types

Boilers type	Volume in boiler	B	A - 24 mm	A - 20 mm	AO	
KC16S	3	2x - C0010	1x - C0008	-	-	
C18, C18S version till 8/2016	7	2x - C0027	5x - C0028	-	-	
C18S, C18SP(L) till 5/2017	5	2x - C0010	1x - C0008	-	2x - C0083	
C18S, C18SP(L), AC25SP(L) AC25S, KC25S, KC25SP(L)	5	2x - C0010	3x - C0008	-	-	
KC35S	6	2x - C0010	4x - C0008	-	-	
AC32SP(L), KC32SP(L)	6	2x - C0010	3x - C0008	1x - C0009	-	
C25ST, C25SP(L)	6	2x - C0010	2x - C0008	-	2x - C0083	
C20, C20S	9	2x - C0027	6x - C0028	1x - C0029	-	
AC35S	9	2x - C0010	6x - C0008	1x - C0009	-	
C30, C30S	10	2x - C0027	7x - C0028	1x - C0029	-	
AC45S, KC45S	10	2x - C0010	7x - C0008	1x - C0009	-	
C32ST	8	2x - C0010	3x - C0008	-	3x - C0083	
C40, C40S, C50S	11	2x - C0010	8x - C0008	1x - C0009	-	

Tab. no. 14 - Grate pipe

Boiler type	Amount of grates	Lenght	Code	Price	Weight
KC16S	3	390	C0077		3,16 kg
C18, C18S version till 8/2016	7	490	C0011		4,44 kg
C18S, C18SP(L), AC25SP(L), AC25S, KC25S, KC25SP(L)	5	490	C0011		4,44 kg
KC35S, AC32SP(L), KC32SP(L)	6	490	C0011		4,44 kg
C25ST, C25SP(L)	6	490	C0011		4,44 kg
C20, C20S, AC35S	9	490	C0011		4,44 kg
C30, C30S, AC45S, KC45S	10	590	C0013		5,16 kg
C32ST	8	590	C0013		4,44 kg
C40, C40S	11	690	C0014		5,86 kg
C50S	11	650	C0015		5,50 kg
DC14R	4	490	C0067		4,58 kg
DC24RS, DC30RS	3	490	C0068		5,54 kg

Table No. 15 - Grate ceramic block

Boiler type	Grate ceramic block wide							
	In front side of the boiler				At the rear side of the boiler			
	Lenght	Code	Price	Weight	Lenght	Code	Price	Weight
C18, KC16S, C18S old version since 8/2016 (7 grates)	108	C0021		5,56 kg	108	C0021		5,56 kg
C20, C20S, AC35S	85	C0022		7,92 kg	85	C0022		7,92 kg
C30, C30S, C25ST, C25SP(L) KC35S, AC45S, KC45S, AC32SP(L), KC32SP(L) C80S	120	C0023		11,32 kg	120	C0023		11,32 kg
C32ST	144	C0030		12,56 kg	144	C0030		12,56 kg
C40, C40S, C50S	200	C0024		16,72 kg	120	C0023		11,32 kg
AC25S, KC25S, C18S new version since 8/2016 (5 grates) C18SP(L), AC25SP(L), KC25SP(L)	132	C0026		6,36 kg	132	C0026		6,36 kg

Table No. 16 - Spherical ceramic chamber 4-pcs Combi Left+Right

Boiler type	Lenght of spherical chamber	Spherical chamber Code left side + right side + rear face	Price	Weight	Spherical chamber Code only for left side + right side	Price	Weight
C15S, KC16S, (DC15GS, GS15)	210 mm low profile	C0048		16,34 kg	C0049		9,66 kg
		consist of: C0075 + C0076 + DC0091			consist of: C0075 + C0076		
KC25S, middle chamber for boilers KCxxSP(L)	310 mm low profile	C0042		21,26 kg	C0043		14,60 kg
		consist of: C0069 + C0070 + DC0091			consist of: C0069 + C0070		
KC35S	310 mm	C0044		25,42 kg	C0045		16,22 kg
		consist of: C0071 + C0072 + C0041			consist of: C0071 + C0072		
KC45S	410 mm	C0046		31,72 kg	C0047		22,56 kg
		consist of: C0073 + C0074 + C0041			consist of: C0073 + C0074		
C18, C18S, AC25S DC14R, DC24RS, DC30RS, middle chamber for boilers CxxSP(L), ACxxSP(L)	310 mm low profile	C0031		21,32 kg	C0036		14,76 kg
		consist of: C0053 + C0054 + DC0091			consist of: C0053 + C0054		
C20, C20S, C25ST AC35S into bottom chamber for burning pellets - DC15EP, DC18SP, CxxSP, ACxxSP, DC18GSP, KCxxSP	310 mm	C0032		25,78 kg	C0037		16,46 kg
		consist of: C0056 + C0057 + C0041			consist of: C0056 + C0057		
into bottom chamber for burning pellets - DC25SP, DC30SPX, DC32SP, DC25GSP, DC30GSP - old version till 31.3.2021	310 mm + 200 mm	DC0171		30,38 kg	DC0172		20,56 kg
		consist of: C0056 + C0057 + 2x DC170 + C0041			consist of: C0056 + C0057 + 2x DC170		
Prolonging of spherical ceramic chamber 200 mm for boilers DC25SP, DC32SP, DC30SPX DCxxGSP – separate (L + R side) - 2 pcs					DC0169		4,60 kg
					2x DC0170		
into the bottom chamber for heating with pellets DC25GSP, DC30GSP - new version till 1.4.2021	510 mm	DC0229		38,98 kg	DC0228		28,80 kg
		consist of: C0059 + C0060 + C0041			consist of: C0059 + C0060		

Notice: By boilers DC25SP, DC30SPX, DC32SP, DC25GSP, DC30GSP spherical ceramic chamber in bottom chamber for burning pellets consists of standard spherical chamber C0032 + ceramic prolonging DC0169

Notice: By boilers DC25GSP, DC30GSP in version until 1. 4. 2021 the spherical ceramic space of bottom chamber is without prolonging

Table No. 16 - Spherical ceramic chamber 4-pcs Combi Left+Right

Boiler type	Lenght of spherical chamber	Spherical chamber Code left side + right side + rear face	Price	Weight	Spherical chamber Code only for left side + right side	Price	Weight
C30, C30S, C32ST AC45S	410 mm	C0033		32,36 kg	C0038		23,66 kg
		consist of: C0059 + C0060 + C0041			consist of: C0059 + C0060		
C40, C40S, C50S, DC70GSX (chamber 600 mm), GSX70 (chamber 600 mm)	510 mm	C0034		37,76 kg	C0039		28,44 kg
		consist of: C0062 + C0063 + C0041			consist of: C0062 + C0063		
C80S	510 mm	C0034		37,76 kg	C0039		28,44 kg
		consist of: C0062 + C0063 + C0041			consist of: C0062 + C0063		
DC100 - complete DC70GSX (chamber 800 mm) GSX70 (chamber 800 mm)	510 mm + 180 mm	C0035 - inc. prolonging		52,56 kg	C0040 - inc. prolonging		42,18 kg
		consist of: C0062 + C0063 + 2x DC0099 + DC0168			consist of: C0062 + C0063 + 2x DC0099		
Prolonging of spherical ceramic chamber (180 mm) L + R side - separate – for boilers DC100, DC70GSX (chamber 800 mm), GSX70 (chamber 800 mm)					C0051		13,78 kg
					2x DC0099		

4. Accessories



Thermostat for putting on pipe



Code: P0011 thermostat, for controlling pumps

Price:
Weight: 0,16 kg

Dual thermostat - IMIT

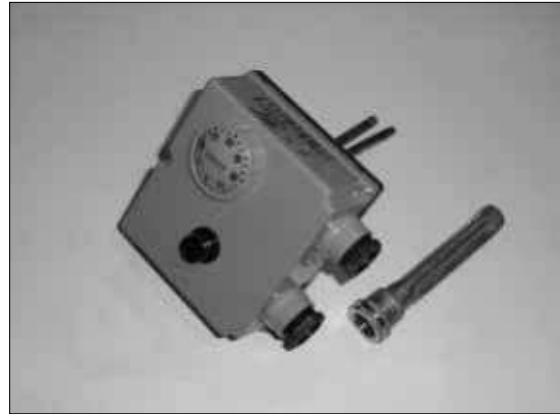

Code: P0442 542714 - thermostat T (0 - 90 °C) / STB (90 - 110 °C) IMIT in to the basin

Price:
Weight: 0,44 kg

Dual thermostat - stem - Honeywell



Code: P0441 T/STB dual thermostat - stem - safety (40 - 110 °C) + operation (30 - 90 °C) - Honeywell

Price:
Weight: 0,42 kg

Dual thermostat - IMIT



Code: P0443 542744/A - thermostat T (60 - 90 °C) / STB (90 - 110 °C) IMIT with 1 m capillary

Price:
Weight: 0,42 kg

Thermometer



Code: P0051 thermometer with connecting point	<i>Price:</i>
	<i>Weight:</i> 0,12 kg

Thermometer for putting on pipe



Code: P0340 attachable thermometer to the pipe D63 / 0 - 120 °C	<i>Price:</i>
	<i>Weight:</i> 0,08 kg

Thermometer for buffer tank



Code: P0076 thermometer for buffer tanks - length 150 mm	<i>Price:</i>
	<i>Weight:</i> 0,20 kg

Manometer RA80-3/8" – 4 bar



Code: S0084 Manometer for heating circuit - RA80-3/8" – 4 bar	<i>Price:</i>
	<i>Weight:</i> 0,12 kg

Code: P0341 Manometer for heating circuit – D100 – 1/2" – 4 bar	<i>Price:</i>
	<i>Weight:</i> 0,24 kg

Basins for buffer tanks



Code: P0078 basin for one thermometer or one sensor - length 200 mm	<i>Price:</i>
	<i>Weight:</i> 0,08 kg

Code: P0079 basin for three sensors – length 230 mm	<i>Price:</i>
	<i>Weight:</i> 0,07 kg

Waste gas thermometer



Code: P0031 waste gas thermometer with basin – complete	<i>Price:</i>
	<i>Weight:</i> 0,30 kg
Code: P0033 pocket for flue gas thermometer - with locking screw G1/2" 107 mm	<i>Price:</i>
	<i>Weight:</i> 0,10 kg
Code: P0036 waste gas thermometer 0 - 450 °C	<i>Price:</i>
	<i>Weight:</i> 0,25 kg

Flue ducts with cleaning lid

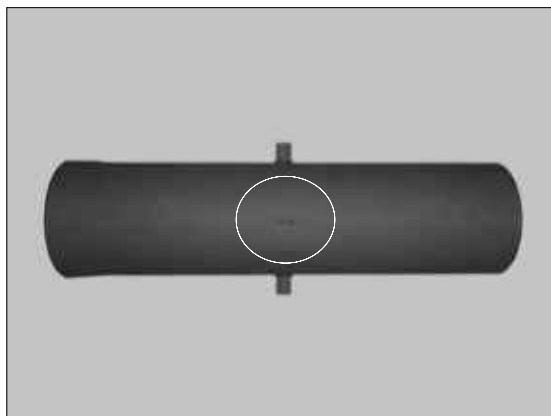

Code: P0042 for boilers with flue duct socket diameter 200 mm (DC100) – lenght 800 mm	<i>Price:</i>
	<i>Weight:</i> 7,60 kg
Code: P0037 for boilers with flue duct socket diameter 180 mm (DC70S, DC75SE) – lenght 750 mm	<i>Price:</i>
	<i>Weight:</i> 7,10 kg
Code: S0161 cleaning lid gasket	<i>Price:</i>
	<i>Weight:</i> 0,01 kg
- for direct connection to the chimney (without elbows) - thickness 2 mm	
- 2x socket for thermometer/sensor basin - G1/2"	

Flue duct with cleaning lid – thickness 5 mm



Code: P0041 for boilers with flue duct socket diameter 152 mm DC18S - DC50S (SE), CxxS, DCxxGSE (GD), DCxxGSP(L), DCxxSX, DCxxGXS, GSXxx, DxxP, Pxx	<i>Price:</i>
- lenght 580 mm	<i>Weight:</i> 12,22 kg
- cleaning lid 105x260 (S0284)	
- 2x socket for thermometer/sensor basin - G1/2"	

Draught regulator (reducer) for chimney



Code: S0195 for regulation (reducing) of draught in chimney, Ø 150 – 180 mm	<i>Price:</i>
	<i>Weight:</i> 0,90 kg

Cleaning set – complete with brush



Code: P0046 for ATMOS Combi CxxS and boilers with spherical combustion chamber (DCxxGS, DC15E, DC14R, DC24RS) - thin	<i>Price:</i>
	<i>Weight:</i> 1,04 kg
Code: P0131 for ATMOS DCxxS (with ceramic roof) and D15, D20 – wide type	<i>Price:</i>
	<i>Weight:</i> 1,08 kg
Code: P0132 for ATMOS DC75SE	<i>Price:</i>
	<i>Weight:</i> 1,36 kg
Code: P0054 for ATMOS DC100, DC105S, DC150S	<i>Price:</i>
	<i>Weight:</i> 1,46 kg
Code: P0057 DC30RS, DCxxGSX D15P, D20P, D30P, D40P, D50P, D80P P15, P20, P30, P40, P50, P80, DxxPX, Pxxx	<i>Price:</i>
	<i>Weight:</i> 1,80 kg
Code: P0070 D14P, D21P, D25P, D31P P14, P21, P25, P31, D85P, P85	<i>Price:</i>
	<i>Weight:</i> 0,98 kg
Code: P0138 DCxxGSE (BVG) (GD), DCxxGSP(L), CxxST	<i>Price:</i>
	<i>Weight:</i> 1,20 kg

Ashtray



Code: P0043 small - 400 mm - C15S, C18S, C20S, KC16S, AC25S, KC25S, AC35S, KC35S, DC18S, DCxxRS, DC15GS, GS15, DC20GS, GS20, DC18SP(L), CxxSP(L), AC/KCxxSP(L), DC18GSP(L), DC18GSE, DC22GSE, DC25GSE - old version	<i>Price:</i>
	<i>Weight:</i> 1,60 kg
Code: P0044 big - 550 mm – C30S, C40S, AC45S, KC45S, DC25GS, DC32GS, DC40GS, DC30SE, DC100, DC30GSE, DC40GSE, DC50GSE, DCxxGSX, DC25GSP(L), DC30GSP(L) DC25GSE - since 15.4.2012	<i>Price:</i>
	<i>Weight:</i> 2,18 kg
Code: P0052 big – DC15E, DxxPX, Pxxx	<i>Price:</i>
	<i>Weight:</i> 2,30 kg
Code: P0060 big – boilers with ceramic roof part + DC105S, DC150S	<i>Price:</i>
	<i>Weight:</i> 2,18 kg

Steel brushes



Code: P0047 35x70 mm - for all boilers: DC18S – DC75SE, C18S – C40S, DCxxGSE, DCxxGD, ACxxS, KCxxS, DCxxSX	<i>Price:</i>
	<i>Weight:</i> 1,10 kg
Code: P0048 Ø 125 mm - for boilers DC100, D15P, D20P, D30P, D40P, D50P, D80P, P15, P20, P30, P40, P50, P80, D30, DC30RS, DCxxGSX, GSXxx, DC105S, DC150S, D85P, P85	<i>Price:</i>
	<i>Weight:</i> 1,16 kg
Code: P0077 Ø 96 mm – for boilers D14P, D21P, D25P, P14, P21, P25, D31P, P31, DxxPX, Pxxx	<i>Price:</i>
	<i>Weight:</i> 1,14 kg
Code: P0059 Ø 65 mm – for boilers DCxxGSE DCxxGD, DCxxGSP(L), CxxST, C50S,	<i>Price:</i>
	<i>Weight:</i> 1,10 kg

Ashtray – for boilers – Dxx, DxxP, Pxx



Code: P0045 for boilers D15, D15P, D20P, P15, P20 – old version small short	<i>Price:</i>
	<i>Weight:</i> 2,20 kg
Code: S0492 for boilers D20 – old version small long	<i>Price:</i>
	<i>Weight:</i> 2,56 kg
Code: P0065 for boilers D15P, D20P, P15, P20, D15 – dimensions 120x262x381 (by types D15P, D20P, P15, P20 from serial number 120000, u typu D15 od 1.1. 2007)	<i>Price:</i>
	<i>Weight:</i> 2,64 kg
Code: P0066 for boilers D20, D30, D30P, D40P, P30, P40, D21 – dimensions 120x262x381 (since 1.1 2007) - 17 Litres	<i>Price:</i>
	<i>Weight:</i> 2,92 kg
Code: P0068 for boilers D50P, P50 - dimensions 120x262x381	<i>Price:</i>
	<i>Weight:</i> 3,40 kg
Code: P0097 for boilers D14P, D21P, P14, P21 - 11 Litres	<i>Price:</i>
	<i>Weight:</i> 3,32 kg
Code: P0080 for boilers D25P, P25, D31P, P31 - 14 Litres	<i>Price:</i>
	<i>Weight:</i> 3,62 kg
Code: P0050 for boilers D80P, P80 - 28 Litres	<i>Price:</i>
	<i>Weight:</i> 5,90 kg
Code: S0158 ashtray sealing - diameter 6 mm - self adhesive - (1 m)	<i>Price:</i>
	<i>Weight:</i> 0,02 kg

Three-way mixing valve



Code: P0312 VRG 131 - DN25 - Kvs10 - ESBE - brass - screwing	<i>Price:</i> <i>Weight:</i> 0,70 kg
Code: P0333 VRG 131 - DN32 - Kvs16 - ESBE - brass - screwing	<i>Price:</i> <i>Weight:</i> 1,03 kg
Code: P0349 VRG 131 - DN40 - Kvs25 - ESBE - brass - screwing	<i>Price:</i> <i>Weight:</i> 2,18 kg
Code: P0344 3G32 – ESBE – cast iron - screwing	<i>Price:</i> <i>Weight:</i> 2,18 kg

Four-way mixing valve



Code: P0342 VRG 141 - DN32 Kvs16 - ESBE	<i>Price:</i> <i>Weight:</i> 1,11 kg
Code: P0345 VRG 141 - DN40 Kvs25 - ESBE	<i>Price:</i> <i>Weight:</i> 2,00 kg

Actuator



Code: P0415 ARA 661 - 230 V - 120 s - 6 Nm - ESBE (for system circuit)	<i>Price:</i> <i>Weight:</i> 0,50 kg
Code: P0517 ARA 651 - 230 V - 60 s - 6 Nm - ESBE (for boiler circuit)	<i>Price:</i> <i>Weight:</i> 0,50 kg

Thermoregulating valve 60/65/70/72 °C



Recommended sizing of valves	
15 kW — 30 kW	- DN25
30 kW — 45 kW	- DN32
45 kW — 99 kW	- DN40, - DN50
Code: P0021 VTC511 25 - 70 °C - DN25 - Kvs9 - ESBE – cast iron	<i>Price:</i> <i>Weight:</i> 0,86 kg
Code: P0022 VTC511 32 - 60/70 °C - DN32 - Kvs14 - ESBE - cast iron	<i>Price:</i> <i>Weight:</i> 1,06 kg
Code: P0030 VTC512 40/60/70 °C - DN40 - Kvs17 - ESBE - cast iron	<i>Price:</i> <i>Weight:</i> 1,38 kg
Code: P0024 spare thermostat cartridge - VTC500_511_512 / 60 °C - ESBE	<i>Price:</i> <i>Weight:</i> 0,20 kg
Code: P0026 spare thermostat cartridge - VTC500_511_512 / 65 °C - ESBE	<i>Price:</i> <i>Weight:</i> 0,20 kg
Code: P0062 spare thermostat cartridge - VTC500_511_512 / 70 °C - ESBE	<i>Price:</i> <i>Weight:</i> 0,20 kg
Code: P0029 TSV 3 DN25 – 65/72 °C – Regulus – brass - G 1"	<i>Price:</i> <i>Weight:</i> 0,80 kg
Code: P0220 TSV 5 DN32 – 65/72 °C – Regulus – brass - G 5/4"	<i>Price:</i> <i>Weight:</i> 0,92 kg
Code: P0067 TSV 6 DN40 – 65/72 °C – Regulus – brass - G 6/4"	<i>Price:</i> <i>Weight:</i> 1,58 kg
Code: P0018 TSV 8 DN50 – 65/72 °C – Regulus – brass - G 2"	<i>Price:</i> <i>Weight:</i> 2,08 kg

Thermostatic mixing valves for heating DHW and for underfloor heating



Code: P0346 ESBE VTA 322-1"- Kvs1.6 35 - 60 °C	<i>Price:</i> <i>Weight:</i> 0,56 kg
Code: P0347 ESBE VTA 522-1"- Kvs3.2 20 - 43 °C	<i>Price:</i> <i>Weight:</i> 0,86 kg
Code: P0348 ESBE VTA 522-1"- Kvs3.2 50 - 75 °C	<i>Price:</i> <i>Weight:</i> 0,86 kg

Laddomat 21



Spare parts

Code: P0103 spare cartridge 78 °C (1456)	<i>Price:</i>
	<i>Weight: 0,20 kg</i>
Code: P0104 spare cartridge 72 °C (8719)	<i>Price:</i>
	<i>Weight: 0,20 kg</i>
Code: P0105 pump WILO RS25/6 - 3	<i>Price:</i>
	<i>Weight: 1,64 kg</i>
Code: P0228 high efficiency pump WILO Yonos PARA MS/ 7,5 - RKC W M	<i>Price:</i>
	<i>Weight: 1,16 kg</i>
Code: P0106 spare fitting with ball valve (5/4")	<i>Price:</i>
	<i>Weight: 0,40 kg</i>
Code: P0102 sealing under the fitting	<i>Price:</i>
	<i>Weight: 0,01 kg</i>
Code: P0107 thermometer	<i>Price:</i>
	<i>Weight: 0,25 kg</i>
Code: P0109 O-ring for thermostat cartridge	<i>Price:</i>
	<i>Weight: 0,02 kg</i>
Code: P0100 spare cartridge 63 °C (5839)	<i>Price:</i>
	<i>Weight: 0,20 kg</i>
Code: P0108 spare cartridge 83 °C (1467)	<i>Price:</i>
	<i>Weight: 0,20 kg</i>
Code: P0110 spare cartridge 87 °C (8222)	<i>Price:</i>
	<i>Weight: 0,20 kg</i>
Code: P0209 tube for locking the back flap	<i>Price:</i>
	<i>Weight: 0,01 kg</i>

Changing reduction Laddomat 21→ Laddomat 22

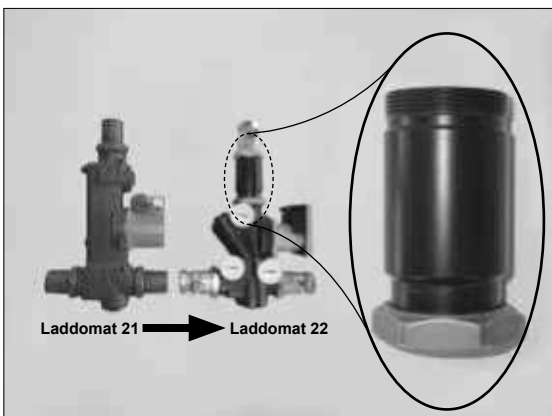

Width of the Laddomat 21 and Laddomat 22 is the same, different is only height which solve this reduction.

Code: P0241 installation reduction from Laddomat 21 to Laddomat 21 without necessary of plumbing changes (no pipe adjustment)	<i>Price:</i>
	<i>Weight: 0,50 kg</i>

Laddomat 22



Code: P0227 Laddomat 22 with high efficiency pump (from 15 up to 100 kW)	<i>Price:</i>
	<i>Weight: 8,82 kg</i>

Spare parts

Code: P0103 spare cartridge 78 °C (1456)	<i>Price:</i>
	<i>Weight: 0,20 kg</i>
Code: P0104 spare cartridge 72 °C (8719)	<i>Price:</i>
	<i>Weight: 0,20 kg</i>
Code: P0225 spare pump RS25/7-3-P	<i>Price:</i>
	<i>Weight: 1,80 kg</i>
Code: P0228 high efficiency pump WILO Yonos PARA MS/ 7,5 - RKC W M	<i>Price:</i>
	<i>Weight: 1,16 kg</i>
Code: P0224 spare screwing with the closing valve (5/4")	<i>Price:</i>
	<i>Weight: 0,72 kg</i>
Code: P0223 spare thermometer	<i>Price:</i>
	<i>Weight: 0,25 kg</i>
Code: P0109 spare O-ring for thermostat cartridge	<i>Price:</i>
	<i>Weight: 0,02 kg</i>
Code: P0235 cartridge holder	<i>Price:</i>
	<i>Weight: 0,05 kg</i>
Code: P0232 spare O-ring for the cap (nut) of the cartridge	<i>Price:</i>
	<i>Weight: 0,01 kg</i>
Code: P0100 spare cartridge 63 °C (5839)	<i>Price:</i>
	<i>Weight: 0,20 kg</i>
Code: P0108 spare cartridge 83 °C (1467)	<i>Price:</i>
	<i>Weight: 0,20 kg</i>
Code: P0110 spare cartridge 87 °C (8222)	<i>Price:</i>
	<i>Weight: 0,20 kg</i>
Code: P0226 blocking clip (spring) for locking the back flap	<i>Price:</i>
	<i>Weight: 0,01 kg</i>
Code: P0231 new version of check valve	<i>Price:</i>
	<i>Weight: 0,14 kg</i>
Code: P0244 plastic tripod	<i>Price:</i>
	<i>Weight: 0,01 kg</i>
Code: P0245 extended spring for cartridge - for version (P0230) without throttle valve and without plastic tripod	<i>Price:</i>
	<i>Weight: 0,04 kg</i>
Code: P0229 complete assembly for storing cartridges including nut - with bypass (throttling valve) and tripod	<i>Price:</i>
	<i>Weight: 0,10 kg</i>
Code: P0230 complete assembly for storing cartridges including nut - without bypass (throttling valve) and tripod	<i>Price:</i>
	<i>Weight: 0,09 kg</i>

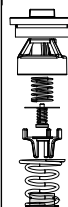

P0229



P0230

High efficiency pump WILO Yonos PICO



Code: P0034 Yonos PICO 25/1 - 4, typ RKA with digital display - without cable - universal type	<i>Price:</i> <i>Weight:</i> 2,20 kg
Code: P0035 Yonos PICO 25/1 - 6, typ RKA with digital display - without cable - universal type	<i>Price:</i> <i>Weight:</i> 2,24 kg

Zone valve with switch



Code: P0384 Z-SF25-2M1-1" - closed without electric income	<i>Price:</i> <i>Weight:</i> 1,14 kg
Code: P0385 O-SF25-2M1-1" - opened without electric income	<i>Price:</i> <i>Weight:</i> 1,16 kg

High efficiency pump WILO Stratos PICO



Code: P0038 Stratos PICO 25/1 - 4, with grafic display - without cable - universal type	<i>Price:</i> <i>Weight:</i> 2,32 kg
Code: P0039 Stratos PICO 25/1 - 6, with grafic display - without cable - universal type	<i>Price:</i> <i>Weight:</i> 2,34 kg

Thermostatic valve for cooling loop



Code: P0073 Honeywell TS 131 – 3/4" ZA 110°C	<i>Price:</i> <i>Weight:</i> 0,93kg
Code: P0081 Honeywell TS 131 – 3/4" ZA 95°C	<i>Price:</i> <i>Weight:</i> 0,76 kg
Code: P0082 WATTS STS 20 – 3/4" 97 °C	<i>Price:</i> <i>Weight:</i> 0,80 kg
Code: P0089 Danfoss BVTS – 3/4"A 95 °C	<i>Price:</i> <i>Weight:</i> 0,90 kg
Code: P0090 Danfoss BVTS – 3/4"A 108 °C	<i>Price:</i> <i>Weight:</i> 0,70 kg

Electric heating spiral



Code: P0125 TJ-M48x2 – 4,5 kW	<i>Price:</i>
	<i>Weight:</i> 2,10 kg
Code: P0126 TJ-M48x2 – 6 kW	<i>Price:</i>
	<i>Weight:</i> 2,30 kg

Ashtray for cleaning tube plate of pellets boilers DxxP



Code: S0548 serves for trouble less cleaning of pellets boilers D15P, D20P, D30P, D40P, D50P, P15, P20, P30, P40, P50	<i>Price:</i>
	<i>Weight:</i> 4,72 kg
Code: S1086 serves for trouble less cleaning of pellets boilers D80P, P80	<i>Price:</i>
	<i>Weight:</i> 4,20 kg

Filling valve G1/2

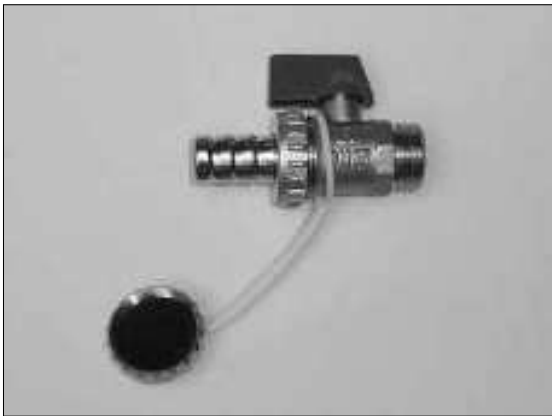

Code: P0211 filling valve for boilers	<i>Price:</i>
	<i>Weight:</i> 0,12 kg

Sealing for ashtray - self adhesive sealing tube



Code: S0158 sealing tube - black - diameter 6 mm - self adhesive - (1 m) for boilers Dxx, DxxP, Pxx	<i>Price:</i>
	<i>Weight:</i> 0,02 kg

Cleaning fire hook - big

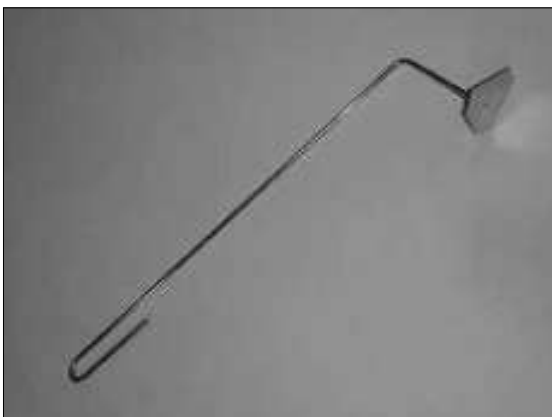

Code: V0343 cleaning fire hook for cleaning burning chamber of the burner A25 or A45 - big	<i>Price:</i>
	<i>Weight:</i> 0,26 kg

Equithermal controller ACD01



Code: P0404 equithermal controller ACD01	<i>Price:-</i>
	<i>Weight: 0,78 kg</i>

it is equithermal controll element for all boilers ATMOS burning solid fuels, which is able to controll heating in two heating circuit, hot domestic water heating, solar heating by solar collectors, optimal charging and discharging of accumulation tanks, automatic switching between two boilers, (e.g. wood boiler and natural gas boiler) and complete operation of the boiler, extraction ventilator when there is need in heating system.

Indoor unit SDW20



Code: P0407 indoor unit SDW20 with display - for controller version 3.0 a 3.3	<i>Price:</i>
	<i>Weight: 0,30 kg</i>

with a digital wall unit you can also remotely control the central unit (e.g. from the living room) to set operation modes, time programs, etc. You can make settings for all the existing heating circuits.

Connection terminal board SCS 12

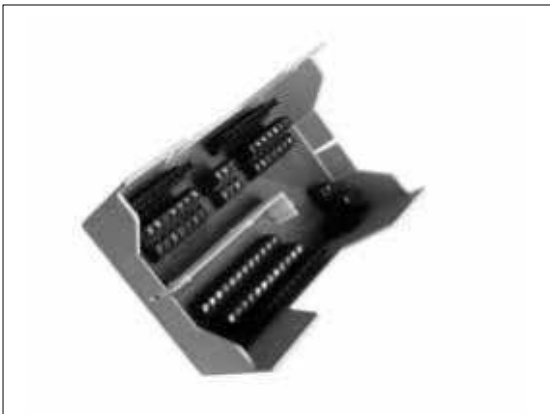

Code: P0405 connection terminal board for equithermal controller ACD01	<i>Price:</i>
	<i>Weight: 0,36 kg</i>

Indoor unit SDW10



Code: P0406 Indoor unit for equithermal controller without screen	<i>Price:</i>
	<i>Weight: 0,25 kg</i>

with a SDW 10 unit you can monitor the room temperature, remotely set the temperature value and change the operation mode of the heating circuit. The settings are only valid for the corresponding heating circuit.

GSM module-controller AB01 ATMOS



Code: P0430 GSM module-controller AB01 ATMOS	<i>Price:</i>
	<i>Weight: 1,60 kg</i>

it is a special multifunction unit, which is use for conntrolling and communication with different units in house or in weekend house over mobile phone (GSM). The main use is for remote control of automatic heating systems with pellets, natural gas and oil boilers. It is special developed for controlling of four-status equithermal regulátor ATMOS ACD 01 or Honeywell type SMILE. It is also able to inform about outside temperature, interior temperature, heating system temperature and communication with other units and appliance. Modul is also equipped with program for optimal controll pellets boiler with acumulation tanks and with program for control two or three boilers in cascade.

Equithermal controller ACD 03 / ACD 04



Code: P0466 Equithermal controller with touchscreen a relay modul ATMOS ACD 03 - complete (A + B with connectors) - without sensors	<i>Price:</i> <i>Weight:</i> 0,67 kg
--	---

Code: P0467 spare - Equithermal controller with touchscreen a relay modul ATMOS ACD 04 - complete (A + B with connectors) - without sensors	<i>Price:</i> <i>Weight:</i> 0,66 kg
--	---

Code: S0105 set of connectors - for controller ATMOS ACD 03/04	<i>Price:</i> <i>Weight:</i> 0,08 kg
---	---

Code: P0463 spare stand alone - equithermal controller with touchscreen ATMOS ACD 03A - without relay modul - without connectors	<i>Price:</i> <i>Weight:</i> 0,38 kg
--	---

Code: P0464 spare stand alone - equithermal controller with touchscreen ATMOS ACD 04A - without relay modul - without connectors	<i>Price:</i> <i>Weight:</i> 0,37 kg
--	---

Code: P0465 spare stand alone - relay modul - ATMOS ACD 03/04-B - without connectors	<i>Price:</i> <i>Weight:</i> 0,22 kg
--	---

Room unit (sensor) - ATMOS ARU5

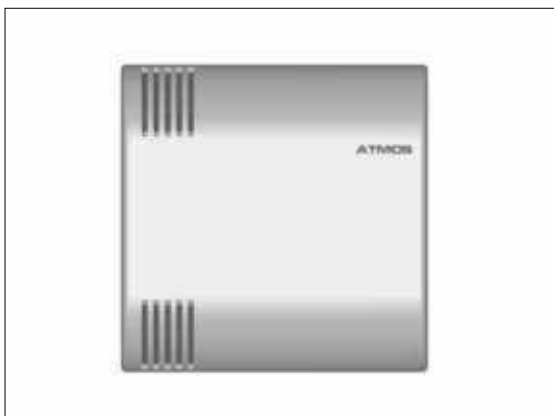

Code: P0471 Room unit (sensor) ATMOS ARU5 - for wired connection	<i>Price:</i> <i>Weight:</i> 0,10 kg
---	---

The ARU5 room unit is a passive room temperature sensor, supplied as an accessory to the ACD 03/04 equithermal controller. It is used to measure the room temperature so that the ACD 03/04 electronic regulation can optimize the heating (water temperature) for the given heating circuit.

Room unit - ATMOS ARU10



Code: P0473 Room unit without touchscreen ATMOS ARU10 - for wired connection	<i>Price:</i> <i>Weight:</i> 0,12 kg
---	---

The ARU10 room unit is intended for simple control of the heating circuit, information about the set modes and for measuring room temperature and humidity. With the help of a rotary wheel, it allows the correction of the desired temperature in the room. By means of the switch button it is possible to change the mode (operation). The ARU10 room unit allows the ACD 03/04 electronic regulation to optimize the heating of the building (water temperature for the given heating circuit).

Room unit - ATMOS ARU30



Code: P0475 Room unit with touchscreen ATMOS ARU30 - for wired connection	<i>Price:</i> <i>Weight:</i> 0,26 kg
--	---

The ARU30 room unit is intended for intuitive control of the heating circuit, informs about the set parameters and modes, for measuring room temperature and humidity. Using the touch screen, it allows you to change the desired temperature in the room depending on time, to change modes using preset functions and to communicate with the ATMOS ACD 03/04 control. The ARU30 room unit allows the ACD 03/04 equithermal controller to optimize the heating of the building (water temperature for the given heating circuit).

Electronic controler AC19



Code: P0449 AC19 controller is designed to control boilers DCxxSR (GSR) or to control pneumatic pellet feeding system APS 250 / 500

<i>Price:</i>
<i>Weight: 0,54 kg</i>

Module AD03



Code: P0436 to control boiler exhaust fan and pump in boiler circuit (solar)

<i>Price:</i>
<i>Weight: 0,20 kg</i>

Module AD01



Code: S0077 elektronic module AD01 for automatic ash removal timing

<i>Price:</i>
<i>Weight: 0,18 kg</i>

Module AD04



Code: P0446 burner module for special functions

<i>Price:</i>
<i>Weight: 0,10 kg</i>

Module AD02



Code: P0432 to control boiler exhaust fan

<i>Price:</i>
<i>Weight: 0,14 kg</i>

Module AD08

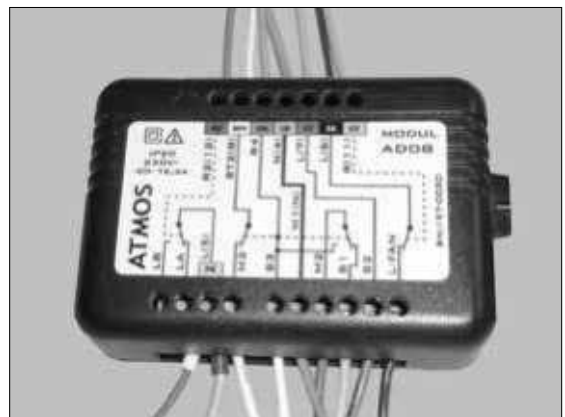

Code: P0450 for special functions of DCxxGSP(L) boilers

<i>Price:</i>
<i>Weight: 0,24 kg</i>

5. Pellet tanks

Pellet tank 250 l

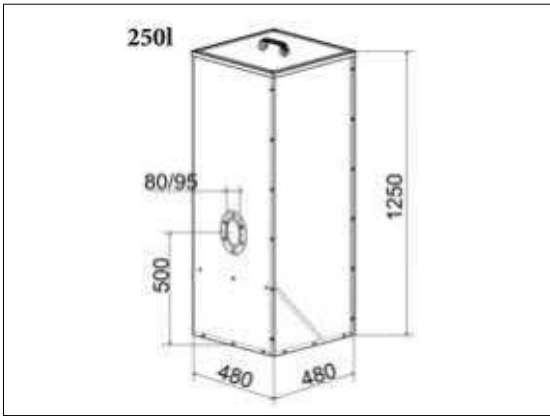

The smallest tank suitable for boilers with output up to 25 kW for smaller boiler-rooms where we can't use bigger silo types. It contains 163 kg of pellets which means approximately 730 kWh.

Code: H0204 volume 250 l - red	<i>Price:</i>
for conveyors DRA50 - 1.7 , 2.5, 4, 5 m DA1500/2000/2500/3000/4000	<i>Weight:</i> 30,00 kg

Code: H0214 volume 250 l - blue	<i>Price:</i>
for conveyors DRA50 - 1.7 , 2.5, 4, 5 m DA1500/2000/2500/3000/4000	<i>Weight:</i> 30,00 kg

Pellet tank 1000 l

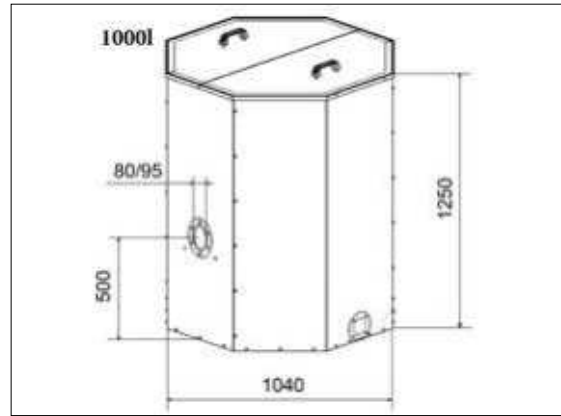

The biggest size tank suitable for boilers with output up to 80 kW. It contains 650 kg of pellets which means approximately 2925 kWh.

Code: H0047 volume 1000 l - red	<i>Price:</i>
for conveyors DRA50 - 1.7 , 2.5, 4, 5 m DA1500/2000/2500/3000/4000	<i>Weight:</i> 68,00 kg

Code: H0046 volume 1000 l - blue	<i>Price:</i>
for conveyors DRA50 - 1.7 , 2.5, 4, 5 m DA1500/2000/2500/3000/4000	<i>Weight:</i> 68,00 kg

Pellet tank 500 l

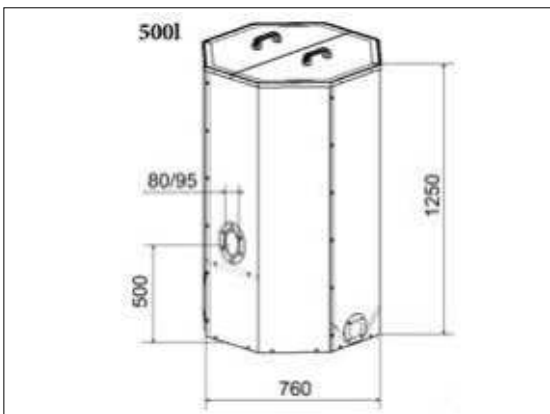

The middle size tank suitable for boilers with output up to 35 kW. It contains 325 kg of pellets which means approximately 1463 kWh.

Code: H0201 volume 500 l - red	<i>Price:</i>
for conveyors DRA50 - 1.7 , 2.5, 4, 5 m DA1500/2000/2500/3000/4000	<i>Weight:</i> 48,00 kg

Code: H0202 volume 500 l - blue	<i>Price:</i>
for conveyors DRA50 - 1.7 , 2.5, 4, 5 m DA1500/2000/2500/3000/4000	<i>Weight:</i> 48,00 kg

Handle



Code: S0230 A) handle for pellet tanks and ash trays	<i>Price:</i>
	<i>Weight:</i> 0,04 kg

Compact pellet tanks - Set AZPD / AZPU

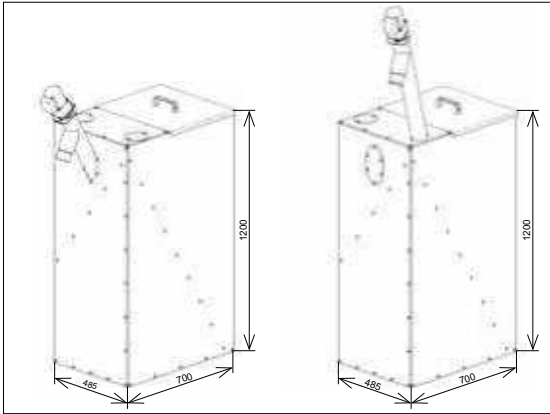

It is a special set of pellet silo of volume 240 litres and a pellet conveyor DRA25. It is designed for small and crowded boiler rooms. It allows placing the pellet tank tightly close to the boiler and needs less space in the boiler room.

The 240 litre silo contains 156 kg of pellets which provides energy of about 700 kWh. (10 bags)

Set AZPD is intended for DxxP pellet boilers and DCxxSP boilers

Code: H0283 Set AZPD 240 R (red) with conveyor DRA25 - 1,3 m (gearbox 25 W)	<i>Price:</i>
	<i>Weight: 54,00 kg</i>

Code: H0284 Set AZPD 240 B (blue) with conveyor DRA25 - 1,3 m (gearbox 25 W)	<i>Price:</i>
	<i>Weight: 54,00 kg</i>

Set AZPU is intended for gasifying boilers with modification for pellet burner

Code: H0280 Set AZPU 240 C (red) with conveyor DRA25 - 1,7 m (gearbox 25 W)	<i>Price:</i>
	<i>Weight: 56,00 kg</i>

Code: H0281 Set AZPU 240 M (blue) with conveyor DRA25 - 1,7 m (gearbox 25 W)	<i>Price:</i>
	<i>Weight: 56,00 kg</i>

Compact pellet tanks - Set AZPD / AZPU

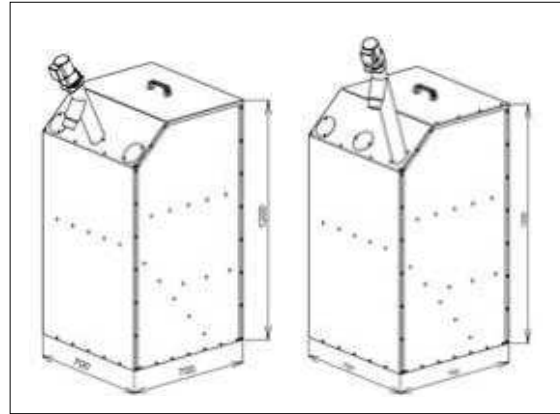

It is a special set of pellet silo of volume 400 litres and a pellet conveyor DRA25. It is designed for small and crowded boiler rooms. It allows placing the pellet tank tightly close to the boiler and needs less space in the boiler room.

The 400 litre silo contains 260 kg of pellets which provides energy of about 1170 kWh. (17 bags)

Set AZPD is intended for DxxP pellet boilers and DCxxSP boilers

Code: H0445 Set AZPD 400 R (red) with conveyor DRA25 - 1,3 m (gearbox 25 W)	<i>Price:</i>
	<i>Weight: 57,50 kg</i>

Code: H0446 Set AZPD 400 B (blue) with conveyor DRA25 - 1,3 m (gearbox 25 W)	<i>Price:</i>
	<i>Weight: 57,50 kg</i>

Set AZPU is intended for gasifying boilers with modification for pellet burner

Code: H0447 Set AZPU 400 C (red) with conveyor DRA25 - 1,7 m (gearbox 25 W)	<i>Price:</i>
	<i>Weight: 58,30 kg</i>

Code: H0448 Set AZPU 400 M (blue) with conveyor DRA25 - 1,7 m (gearbox 25 W)	<i>Price:</i>
	<i>Weight: 58,30 kg</i>

Compact pellet tank - Set AZPD 300 - Design

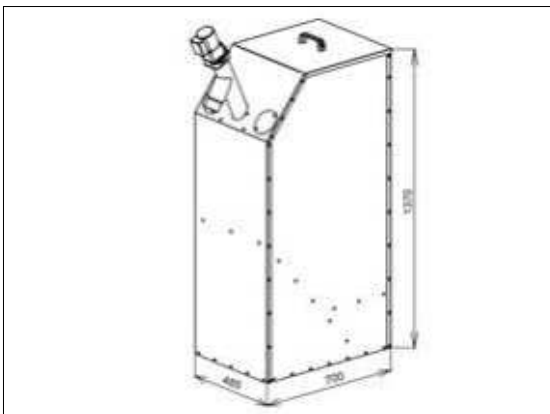

Set AZPD is intended for DxxP pellet boilers and DCxxSP boilers. It is a special set of pellet silo of volume 300 litres and a pellet conveyor DRA25. It is designed for small and crowded boiler rooms. It allows placing the pellet tank tightly close to the boiler and needs less space in the boiler room.

The 300 litres silo contains 195 kg of pellets which provides energy of about 880 kWh. (13 bags)

Code: H0321 Set AZPD 300 R - Design (red) with conveyor DRA25 - 1,3 m (gearbox 25 W)	<i>Price:</i>
	<i>Weight: 55,00 kg</i>

Code: H0322 Set AZPD 300 B - Design (blue) with conveyor DRA25 - 1,3 m (gearbox 25 W)	<i>Price:</i>
	<i>Weight: 55,00 kg</i>

Conveyors for compact pellet tanks AZPD/U



Code: H0287 conveyor with shaft DRA25 - 1,3 m (gearbox 25 W)	<i>Price:</i>
	<i>Weight:</i> 9,54 kg
Code: H0286 conveyor with shaft DRA25 - 1,7 m (gearbox 25 W)	<i>Price:</i>
	<i>Weight:</i> 10,47 kg
Spare auger with shaft for conveyor DRA25	
Code: H0036 spare auger for conveyor DRA25 - 1,3 m	<i>Price:</i>
	<i>Weight:</i> 2,09 kg
Code: H0025 spare auger for conveyor DRA25 - 1,7 m	<i>Price:</i>
	<i>Weight:</i> 2,56 kg
Spare tube of conveyor DRA25	
Code: H0289 spare tube of conveyor DRA25 - 1,3 m	<i>Price:</i>
	<i>Weight:</i> 4,23 kg
Code: H0288 spare tube of conveyor DRA25 - 1,7 m	<i>Price:</i>
	<i>Weight:</i> 5,16 kg
Spare gear box of the conveyor DRA25	
Code: H0107 gearbox of the conveyor 25W for conveyors DRA25 - 1.3 a 1.7 m	<i>Price:</i>
	<i>Weight:</i> 2,72 kg
Spare bearing for conveyor	
Code: H0198 complete set - bearing + pocket - 2 pcs	<i>Price:</i>
	<i>Weight:</i> 0,22 kg
Parts for connectin of the conveyor gearbox	
Code: V0147 flange for DRA25 conveyor - gearbox (25 W)	<i>Price:</i>
	<i>Weight:</i> 0,22 kg
Code: V0529 locking pivot	<i>Price:</i>
	<i>Weight:</i> 0,03 kg
Code: V0140 locking brace for conveyor - DRA	<i>Price:</i>
	<i>Weight:</i> 0,03 kg

Pellet tank for boilers DxxPX, PXxx

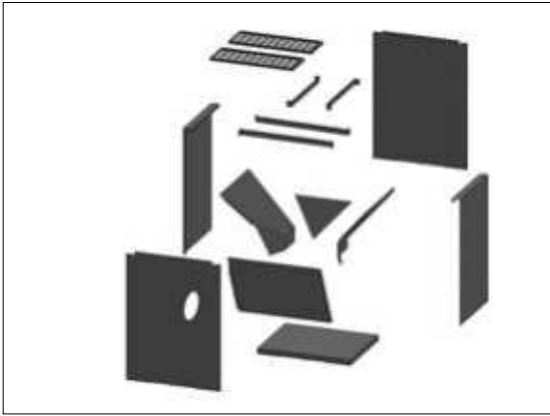

Code: H0339 pellet tank for boilers D10PX, PX10	<i>Price:</i>
	<i>Weight:</i> 23,10 kg
Code: H0300 pellet tank for boilers D15-20PX, PX15-20	<i>Price:</i>
	<i>Weight:</i> 38,80 kg
Code: H0340 pellet tank for boilers D25PX, PX25	<i>Price:</i>
	<i>Weight:</i> 48,90 kg
Code: S1259 insulation under the tank D10PX, PX10	<i>Price:</i>
	<i>Weight:</i> 0,33 kg
Code: S1216 insulation under the tank - Sibral - D15-20PX, PX15-20	<i>Price:</i>
	<i>Weight:</i> 0,64 kg
Code: S1307 insulation under the tank D25PX, PX25	<i>Price:</i>
	<i>Weight:</i> 0,85 kg
Code: S1369 removable protective grid - 1 kus - D10PX, PX10	<i>Price:</i>
	<i>Weight:</i> 3,85 kg
Code: S1290 removable protective grid - 2 pcs - D15-20PX, PX15-20	<i>Price:</i>
	<i>Weight:</i> 3,85 kg
Code: S1370 removable protective grid - 2 kusy - D25PX, PX25	<i>Price:</i>
	<i>Weight:</i> 5,08 kg
Code: S1371 grid holder - 4 parts D10PX, PX10	<i>Price:</i>
	<i>Weight:</i> 2,08 kg
Code: S1291 grid holder - 4 parts D15-20PX, PX15-20	<i>Price:</i>
	<i>Weight:</i> 2,60 kg
Code: S1372 grid holder - 4 parts D25PX, PX25	<i>Price:</i>
	<i>Weight:</i> 2,96 kg

Sibral gasket for conveyor DxxPX, PXxx

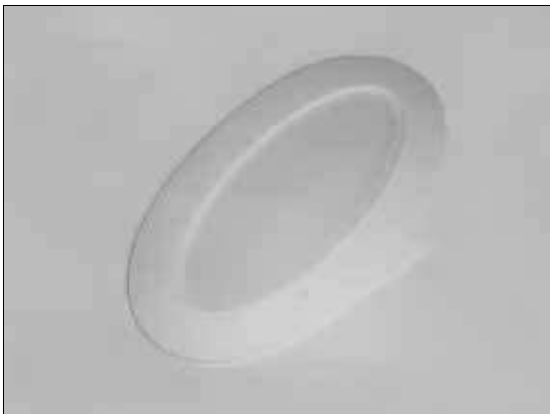

Code: S1258 sibral gasket between conveyor and tank - 4 mm - D10PX	<i>Price:</i>
	<i>Weight:</i> 0,02 kg
Code: S1237 sibral gasket between conveyor and tank - 4 mm - D15-20PX	<i>Price:</i>
	<i>Weight:</i> 0,02 kg
Code: S1257 sibral gasket between conveyor and tank - 4 mm - D25PX	<i>Price:</i>
	<i>Weight:</i> 0,02 kg

Conveyors for boilers DxxPX, PXxx



Code: H0341 conveyor DRA25 for boiler D10PX, PX10 - (gearbox 25 W)	<i>Price:</i>
	<i>Weight:</i> 6,86 kg
Code: H0309 conveyor DRA25 for boiler D15-20PX, PX15-20 - (gearbox 25 W)	<i>Price:</i>
	<i>Weight:</i> 7,47 kg
Code: H0342 conveyor DRA25 for boiler D25PX, PX25 - (gearbox 25 W)	<i>Price:</i>
	<i>Weight:</i> 7,36 kg
Spare auger with shaft for conveyor DRA25	
Code: H0099 spare auger for conveyor DRA25 - D10PX, PX10	<i>Price:</i>
	<i>Weight:</i> 0,89 kg
Code: H0011 spare auger for conveyor DRA25 - D15PX, D20PX, PX15, PX20	<i>Price:</i>
	<i>Weight:</i> 1,05 kg
Code: H0117 spare auger for conveyor DRA25 - D25PX, PX25	<i>Price:</i>
	<i>Weight:</i> 1,09 kg
Spare tube of conveyor DRA25	
Code: H0139 spare tube of conveyor DRA25 - D10PX, PX10	<i>Price:</i>
	<i>Weight:</i> 2,39 kg
Code: H0294 spare tube of conveyor DRA25 - D15PX, D20PX, PX15, PX20	<i>Price:</i>
	<i>Weight:</i> 2,36 kg
Code: H0140 spare tube of conveyor DRA25 - D25PX, PX25	<i>Price:</i>
	<i>Weight:</i> 2,87 kg
Spare gear box of the conveyor DRA25	
Code: H0107 gearbox of the conveyor 25W for conveyors DRA25 - DxxPX, PXxx	<i>Price:</i>
	<i>Weight:</i> 2,72 kg
Spare bearing for conveyor	
Code: H0198 complete set - bearing + pocket - 2 pcs	<i>Price:</i>
	<i>Weight:</i> 0,22 kg
Parts for connectin of the conveyor gearbox	
Code: V0147 flange for DRA25 conveyor - gearbox (25 W)	<i>Price:</i>
	<i>Weight:</i> 0,22 kg
Code: V0529 locking pivot	<i>Price:</i>
	<i>Weight:</i> 0,03 kg
Code: V0140 locking brace for conveyor - DRA	<i>Price:</i>
	<i>Weight:</i> 0,03 kg

6. Accumulation tanks - DH / DZ

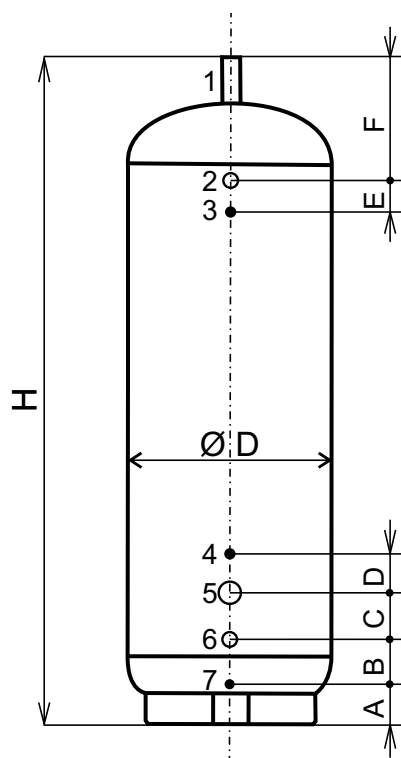

Description:

Volume 500, 600, 750, 800 and 1000 l

1. sleeve piece
2. upper outlet
3. sleeve for thermometer
4. sleeve for thermometer
5. sleeve for electric heating element
6. lower outlet
7. sleeve for bleeding valve

New accumulation tanks type DH

Dimensions of tanks type DH

Type	Dimension (mm)							Diameter (mm)							
	H	A	B	C	D	E	F	Ø D	1	2	3	4	5	6	7
AN 750	1750	140	95	110	130	90	366	790	5/4"	5/4"	1/2"	1/2"	M48x2	5/4"	1"
AN 800	1910	175	101	110	130	90	374	790	5/4"	5/4"	1/2"	1/2"	M48x2	5/4"	1"
AN 1000	2210	140	95	110	130	90	366	790	5/4"	5/4"	1/2"	1/2"	M48x2	5/4"	1"

Uninsulated tanks type DH

Type	Code	Price	Weight
AN 750	P0170		120,00 kg
AN 800	P0199		116,00 kg
AN 1000	P0171		132,00 kg

Insulated tanks type DH

Type	Code tank inc. insulation	Price	Weight	Code of sep. insulation	Price	Weight
AN 750	P0176		142,00 kg	P0173		22,00 kg
AN 800	P0201		138,00 kg	P0200		22,00 kg
AN 1000	P0177		161,00 kg	P0174		25,00 kg

Uninsulated tanks with inner boiler for DHW 200 l – type DH

Type	Code	Price	Weight
AN 500/2	P0178		
AN 750/2	P0179		
AN 800/2	P0202		160,00
AN 1000/2	P0180		

Insulated tanks with inner boiler for DHW 200 l – type DH

Type	Code tank inc. insulation	Price	Weight	Code of sep. insulation	Price	Weight
AN 500/2	P0184		kg	P0181		kg
AN 750/2	P0185		kg	P0182		kg
AN 800/2	P0204		185,00 kg	P0203		25,00 kg
AN 1000/2	P0186		kg	P0183		kg

Uninsulated tanks with inner boiler for DHW 140 l and with coil for connecting solar – type DH

Type	Code	Price	Weight
AN 500/3	P0187		
AN 750/3	P0188		
AN 800/3 - 2,3m ²	P0205		170,00 kg
AN 1000/3	P0189		

Insulated tanks with inner boiler for DHW 140 l and with coil for connecting solar – type DH

Type	Code tank inc. insulation	Price	Weight	Code of sep. insulation	Price	Weight
AN 500/3	P0193		kg	P0190		kg
AN 750/3	P0194		kg	P0191		kg
AN 800/3 - 2,3m ²	P0207		196,00 kg	P0206		25,00 kg
AN 1000/3	P0195		kg	P0192		kg

Acumulation tanks type DZ
Dimensions of tanks type DZ

Type	Dimension (mm)							Diameter (mm)							
	H	A	B	C	D	E	F	Ø D	1	2	3	4	5	6	7
AN 500	1970	127	131	110	130	90	326	600	5/4"	5/4"	1/2"	1/2"	M48x2	5/4"	1/2"
AN 600	1611	169	131	110	130	90	341	750	5/4"	5/4"	1/2"	1/2"	M48x2	5/4"	1/2"
AN 750	1974	154	131	110	130	90	329	750	5/4"	5/4"	1/2"	1/2"	M48x2	5/4"	1/2"
AN 1000	2065	175	108	110	130	90	342	850	5/4"	5/4"	1/2"	1/2"	M48x2	5/4"	1/2"

Uninsulated tanks type DZ

Type	Code	Price	Weight
AN 500	P0139		91,00 kg
AN 600	P0236		82,00 kg
AN 750	P0140		120,00 kg
AN 1000	P0141		136,00 kg

Insulated tanks type DZ

Type	Code	Price	Weight
AN 500	P0142		114,00 kg
AN 600	P0238		100,00 kg
AN 750	P0143		144,00 kg
AN 1000	P0144		161,00 kg

Uninsulated tanks with inner boiler for DHW 200 l – type DZ

Type	Code	Price	Weight
AN 500/2	P0145		133,00 kg
AN 750/2	P0146		168,00 kg
AN 1000/2	P0147		181,00 kg

Insulated tanks with inner boiler for DHW 200 l – type DZ

Type	Code	Price	Weight
AN 500/2	P0148		156,00 kg
AN 750/2	P0149		198,00 kg
AN 1000/2	P0150		206,00 kg

Uninsulated tanks with inner boiler for DHW 140 l and with coil for connecting solar – type DZ

Type	Code	Price	Weight
AN 500/3 - 1,7 m ²	P0160		151,00 kg
AN 750/3 - 2,3 m ²	P0161		185,00 kg
AN 1000/3 - 3,3 m ²	P0162		217,00 kg

Insulated tanks with inner boiler for DHW 140 l and with coil for connecting solar – type DZ

Type	Code	Price	Weight
AN 500/3 - 1,7 m ²	P0163		174,00 kg
AN 750/3 - 2,3 m ²	P0164		215,00 kg
AN 1000/3 - 3,3 m ²	P0165		242,00 kg

Tank type DZ – product of company DZ Dražice - CZ

Tank type DH – product of company HUCH or Dražice – DE/CZ

7. ATMOS A25 pellet burner



Pellet burner - ATMOS A25



Code: H0014 burner – red - (4 - 24 kW)	<i>Price:</i>
	<i>Weight: 17,66 kg</i>
Code: H0044 burner – red - (4 - 24 kW) - for boilers DxxPX, PXxx	<i>Price:</i>
	<i>Weight: 17,70 kg</i>
Code: H0048 burner – red - (4 - 24 kW) - for boilers DCxxSP, CxxSP - model 2018/19	<i>Price:</i>
	<i>Weight: 19,70 kg</i>
Code: H0042 burner – blue - (4 - 24 kW) - for boilers DCxxGSP	<i>Price:</i>
	<i>Weight: 19,70 kg</i>
Code: H0238 fuse for ignitaton spiral – type F3.15A/1500A/5x20 mm – into the burner	<i>Price:</i>
	<i>Weight: 0,01 kg</i>
Code: H0239 fuse for ventilator or conveyor spiral – type F0.8A/1500A/5x20 mm	<i>Price:</i>
	<i>Weight: 0,01 kg</i>
Code: H0251 fuse for conveyor – type F1.0A/1500A/5x20 mm	<i>Price:</i>
	<i>Weight: 0,01 kg</i>

Conveyors for burner ATMOS A25



Code: H0151 pellet conveyor DA1500 - 1,5 m (gearbox 25 W)	<i>Price:</i>
	<i>Weight: 11,50 kg</i>
Code: H0207 pellet conveyor DA2000 - 2 m (gearbox 25 W)	<i>Price:</i>
	<i>Weight: 13,00 kg</i>
Code: H0208 pellet conveyor DA2500 - 2,5 m (gearbox 25 W)	<i>Price:</i>
	<i>Weight: 14,00 kg</i>
Code: H0209 pellet conveyor DA3000 - 3 m (gearbox 40 W)	<i>Price:</i>
	<i>Weight: 15,50 kg</i>
Code: H0212 pellet conveyor DA4000 - 4 m (gearbox 40 W)	<i>Price:</i>
	<i>Weight: 18,50 kg</i>

Electronic unit of the burner

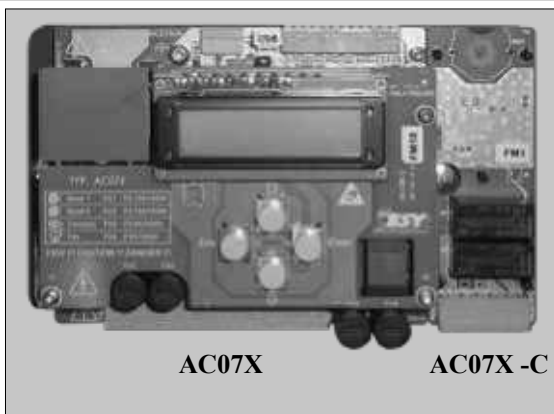

AC07X

AC07X -C

Code: H0222 spare electronic unit of the burner - AC07 (ACO7X - since 2012) from serial number 1375) with a fixation plate	<i>Price:</i>
	<i>Weight: 0,70 kg</i>
Code: H0310 electronic unit ACO7X + MC (Module C (AC07X - C)) with an enlarged fixation plate	<i>Price:</i>
	<i>Weight: 0,85 kg</i>
Code: H0337 additional module ACO7X - C - (R5, R6) to control pneumatic cleaning system of burner or other aplications - separate	<i>Price:</i>
	<i>Weight: 0,10 kg</i>
Code: H0427 additional module ACO7X - C - (R5, R6) with a holder for fixing on plate of electronic unit AC07X - since 2019	<i>Price:</i>
	<i>Weight: 0,14 kg</i>

Gearbox of the conveyor DAxxxx



Code: H0107 gearbox of the conveyor 25W for conveyors DA1500, DA2000, DA2500 diameter of the shaft - 10 mm	<i>Price:</i>
	<i>Weight: 2,72 kg</i>
Code: H0159 gearbox of the conveyor 40W for conveyors DA3000 and DA4000	<i>Price:</i>
	<i>Weight: 4,50 kg</i>
Code: H0113 gearbox capacitor for conveyors DA a DRA	<i>Price:</i>
	<i>Weight: 0,06 kg</i>

Spare spiral for conveyor DAxxxx

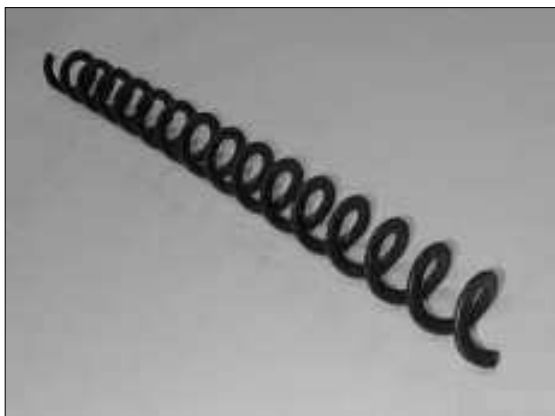

Code: H0254 spiral for conveyor DA1500	<i>Price:</i>
	<i>Weight: 1,08 kg</i>
Code: H0255 spiral for conveyor DA2000	<i>Price:</i>
	<i>Weight: 1,42 kg</i>
Code: H0256 spiral for conveyor DA2500	<i>Price:</i>
	<i>Weight: 1,76 kg</i>
Code: H0263 spiral for conveyor DA3000	<i>Price:</i>
	<i>Weight: 2,16 kg</i>
Code: H0264 spiral for conveyor DA4000	<i>Price:</i>
	<i>Weight: 2,84 kg</i>

Elements for connection spiral of the conveyor type DAxxxx



Code: H0257 complete set – element for connection spiral to the gearbox of engine 25 W + spare special screw (hook), nut and washer + grub screw (2 pcs)	<i>Price:</i>
	<i>Weight: 0,25 kg</i>
Code: H0258 separate spare element - 1 pc - gearbox 25 W	<i>Price:</i>
	<i>Weight: 0,22 kg</i>
Code: H0279 separate spare element – 1 ks - gearbox 40 W	<i>Price:</i>
	<i>Weight: 0,20 kg</i>
Code: H0259 special screw (hook), nut and washer – 1pc	<i>Price:</i>
	<i>Weight: 0,02 kg</i>
Code: S1001 grub screw M5 – 1pc	<i>Price:</i>
	<i>Weight: 0,01 kg</i>

Leg and flange for conveyors - type DA



Code: S0992 flange – separate for conveyors DA1500, DA2000 a DA2500	<i>Price:</i>
	<i>Weight: 1,60 kg</i>
Code: S0962 flange – separate for conveyors DA3000 a DA4000	<i>Price:</i>
	<i>Weight: 1,62 kg</i>
Code: H0414 leg for conveyors DA2000 - DA4000	<i>Price:</i>
	<i>Weight: 2,30 kg</i>
Code: H0415 leg for conveyor DA1500	<i>Price:</i>
	<i>Weight: 2,10 kg</i>

Transparent tube for conveyor DAxxxx



Code: H0261 transparent tube 1 m – without recess	<i>Price:</i>
	<i>Weight: 1,14 kg</i>
Code: H0253 transparent tube 1 m – with recess	<i>Price:</i>
	<i>Weight: 1,20 kg</i>
Code: H0266 transparent tube 1,5 m – without recess	<i>Price:</i>
	<i>Weight: 1,62 kg</i>
Code: H0252 transparent tube 1,5 m – with recess	<i>Price:</i>
	<i>Weight: 1,68 kg</i>
Code: H0273 transparent tube 2 m – without recess	<i>Price:</i>
	<i>Weight: 2,20 kg</i>
Code: H0240 transparent tube 2 m – with recess	<i>Price:</i>
	<i>Weight: 2,26 kg</i>
Code: H0241 transparent tube 2,5 m – with recess	<i>Price:</i>
	<i>Weight: 2,84 kg</i>
Code: V0120 connection for tubes - H0261 and H253 with 6 screws	<i>Price:</i>
	<i>Weight: 0,80 kg</i>
Code: V0133 connection - for conveyor 4 m - perforated - with 6 screws	<i>Price:</i>
	<i>Weight: 2,63 kg</i>

Pellet supply hose



Code: H0066 spare hose between burner and pellet conveyor - lenght 1 m and Ø 65 mm - transparent

Price:
Weight: 0,68 kg

Code: H0302 hose clamp 60 - 80 mm

Price:
Weight: 0,02 kg

Top cover of the burner mouth



Code: H0220 top cover of the burner mouth

Price:
Weight: 0,87 kg

Combustion chamber (pot) of the burner

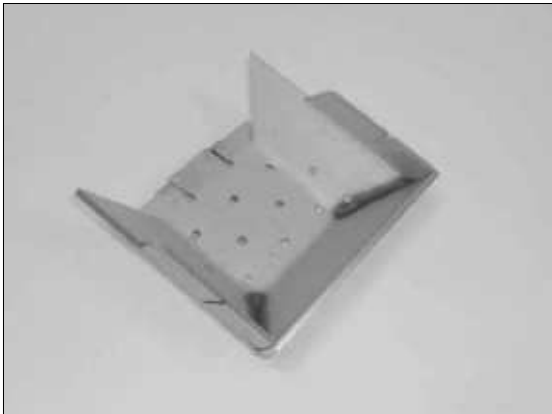

Code: H0228 combustion chamber (pot) of the burner from serial number 160

Price:
Weight: 0,84 kg

Code: H0053 combustion chamber (pot) of the burner to serial number 160

Price:
Weight: 0,80 kg

Code: H0350 combustion chamber (pot) for pellet burners DxxPX, PXxx

Price:
Weight: 0,98 kg

Inner holder of the ignition spiral

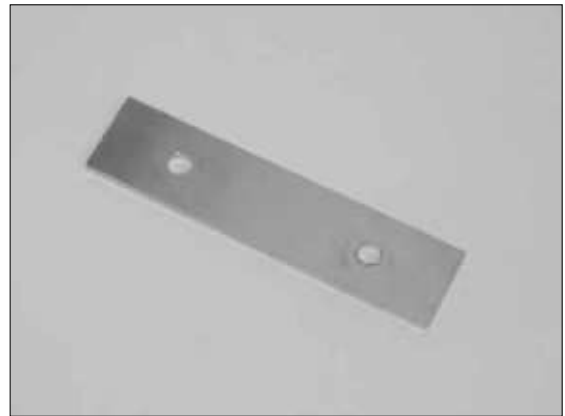

Code: H0227 inner holder of the ignition spiral

Price:
Weight: 0,11 kg

Holder - plate with openings for the ignition spirals



Code: H0225 holder - plate with openings for the ignition spirals

Price:
Weight: 0,85 kg

Ignition spiral cover

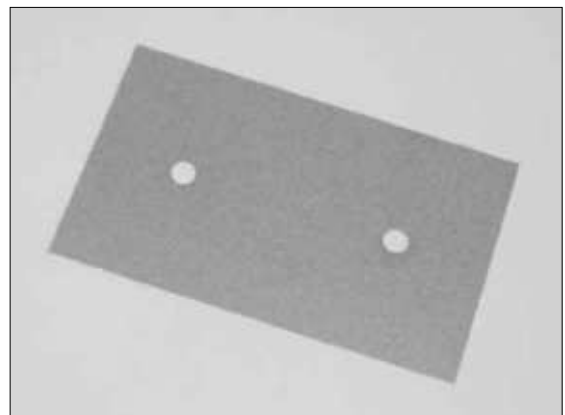

Code: H0226 ignition spiral cover

Price:
Weight: 0,08 kg

Pellet supply pipe



Code: H0223 pellet supply pipe	<i>Price:</i>
	<i>Weight: 0,60 kg</i>

Code: H0297 pellet supply pipe for boilers - DxxPX, Pxxx - straight	<i>Price:</i>
	<i>Weight: 0,50 kg</i>

Fan with a speed sensor and with air flap

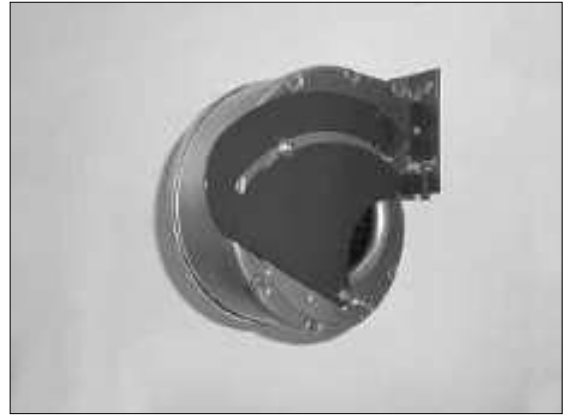

Code: H0058 fan with a speed sensor and with air flap	<i>Price:</i>
	<i>Weight: 1,12 kg</i>

Gasket under the flange of the pellet supply pipe



Code: S0170 gasket under the flange of the pellet supply pipe - sibral paper	<i>Price:</i>
	<i>Weight: 0,01 kg</i>

Gasket under the fan - A25



Code: S0156 gasket under the flange of the burner fan - A25 - 72 x 79 mm	<i>Price:</i>
	<i>Weight: 0,01 kg</i>

End switch stop



Code: H0237 end switch stop	<i>Price:</i>
	<i>Weight: 0,06 kg</i>

Air flap of the fan



Code: H0230 air flap of the fan	<i>Price:</i>
	<i>Weight: 0,10 kg</i>

Ignition spiral



Code: H0229 spare ignition spiral 500W	<i>Price:</i>
	<i>Weight: 0,18 kg</i>
Code: H0108 spare cable for ignition spirals	<i>Price:</i>
	<i>Weight: 0,04 kg</i>

Holder of the electronic unit

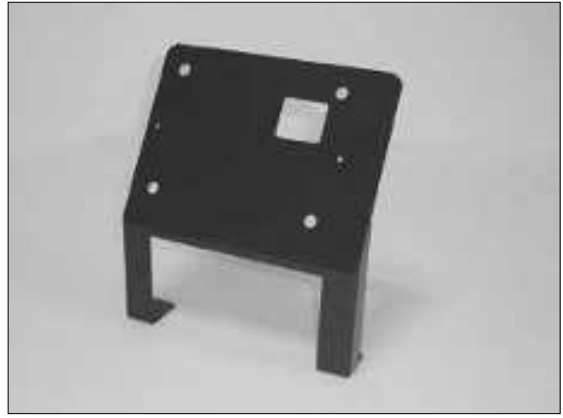

Code: H0221 holder of the electronic unit	<i>Price:</i>
	<i>Weight: 0,70 kg</i>

Safety thermostat cover



Code: H0224 safety thermostat cover	<i>Price:</i>
	<i>Weight: 0,05 kg</i>

Burner cover - A25 - hood with a window for display



Code: H0219 burner cover - hood with a window for the display	<i>Price:</i>
	<i>Weight: 1,50 kg</i>
Code: H0274 burner cover - red - hood with a window for the display - model (AC07X)	<i>Price:</i>
	<i>Weight: 1,50 kg</i>
Code: H0292 burner cover - blue - hood with a window for the display - model (AC07X)	<i>Price:</i>
	<i>Weight: 1,50 kg</i>

Safety thermostat on pellet supply pipe 55 °C / 95 °C



Code: H0059 safety thermostat to burner supply pipe 95 °C	<i>Price:</i>
	<i>Weight: 0,02 kg</i>
Code: H0098 safety thermostat to burner supply pipe 55 °C - for DxxPX, PXxx	<i>Price:</i>
	<i>Weight: 0,02 kg</i>

Display self-sticking label

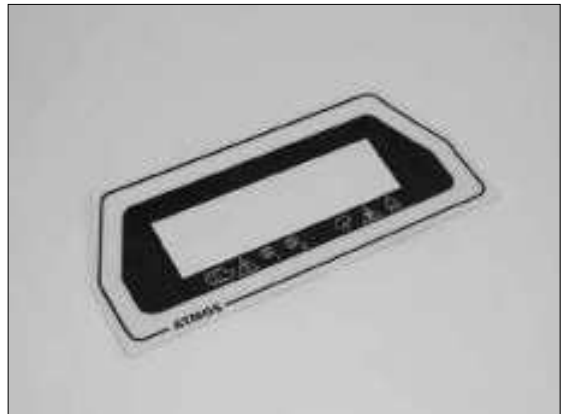

Code: H0236 display self-sticking label	<i>Price:</i>
	<i>Weight: 0,01 kg</i>

Electric wiring of the burner

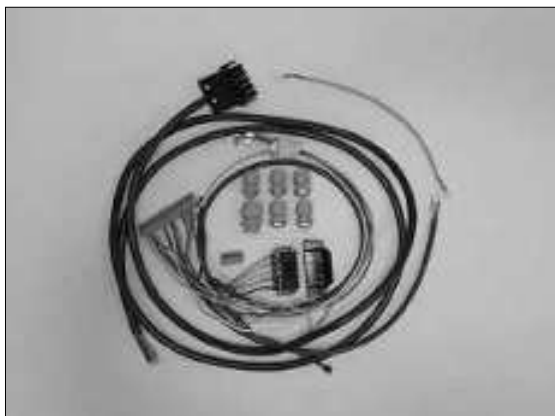

Code: H0216 electric wiring of the burner, incl. bushings and connectors - AC07	<i>Price:</i>
	<i>Weight: 1,00 kg</i>
Code: H0216 electric wiring of the burner, incl. bushings and connectors - AC07X	<i>Price:</i>
	<i>Weight: 1,10 kg</i>
Code: H0296 electric wiring of the burner AC07X - for boilers DxxPX, PXxx	<i>Price:</i>
	<i>Weight: 1,10 kg</i>
Code: H0333 electric wiring of the burner AC07X - for boilers Pxx Compact (EU)	<i>Price:</i>
	<i>Weight: 1,10 kg</i>

AC07 electronic unit connector (1 - 16) PIN – bottom

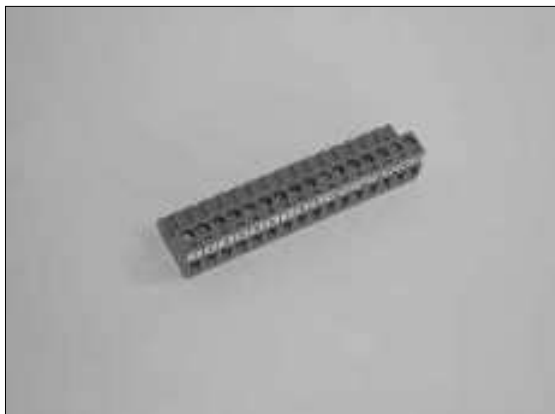

Code: H0234 electronic unit connector (1 - 16) - bottom	<i>Price:</i>
	<i>Weight: 0,03 kg</i>

AC07 and AC07X electronic unit connector

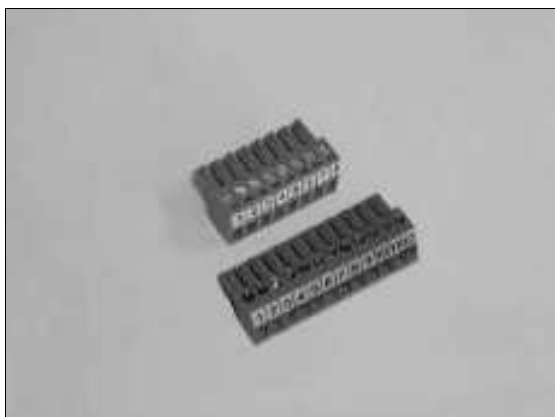

Code: H0235 electronic unit connector (1 - 8) - top for unit AC07	<i>Price:</i>
	<i>Weight: 0,01 kg</i>
Code: H0260 electronic unit connector (1 - 12) - top for unit AC07X	<i>Price:</i>
	<i>Weight: 0,01 kg</i>

Photocell

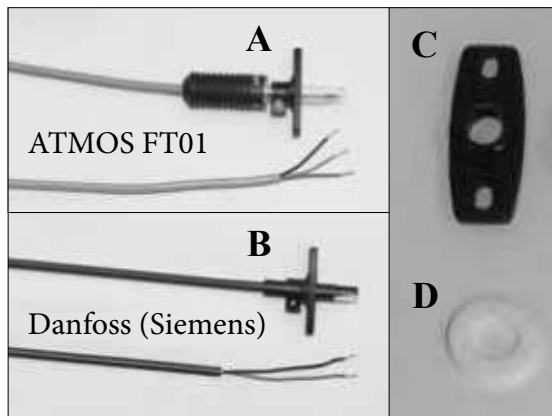

Code: H0330 spare photocell – stand alone ATMOS FT01 - for unit AC07X - with power supply - the polarity of the wires must be observed	<i>Price:</i>
	<i>Weight: 0,05 kg</i>
Code: H0331 A - spare photocell – komplet ATMOS FT01 + holder	<i>Price:</i>
	<i>Weight: 0,07 kg</i>
Code: H0231 spare photocell – stand alone Danfoss (Siemens) - for unit AC07	<i>Price:</i>
	<i>Weight: 0,03 kg</i>
Code: H0055 B - spare photocell – complete Danfoss (Siemens) + holder	<i>Price:</i>
	<i>Weight: 0,07 kg</i>
Code: H0232 C - photocell holder	<i>Price:</i>
	<i>Weight: 0,02 kg</i>
Code: S0155 D - photocell seal	<i>Price:</i>
	<i>Weight: 0,01 kg</i>

The connecting cable for the fan speed sensing



Code: H0109 the connecting cable for the fan speed sensing	<i>Price:</i>
	<i>Weight: 0,05 kg</i>

End switch of the burner



Code: H0210 end switch of the burner – FR501	<i>Price:</i>
	<i>Weight: 0,08 kg</i>

Burner connector with lid - supply - power

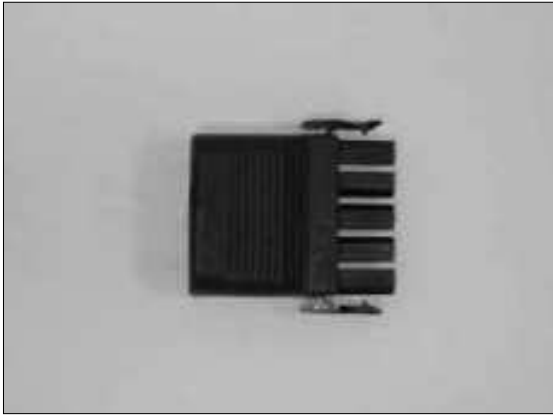

Code: S0902 connector (NAC 52S.B) female with cabel – 5-pin	<i>Price:</i> <i>Weight: 0,44 kg</i>
---	---

Burner connector with bushing - power



Code: S0989 connector - male – 6-pin - for control unit (AC07X)	<i>Price:</i> <i>Weight: 0,02 kg</i>
---	---

Burner connector with bushing - power

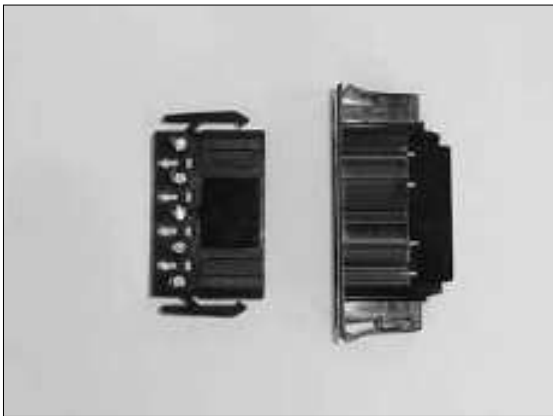

Code: S0914 connector (NAC 51.B) – male with bushing – 5-pin	<i>Price:</i> <i>Weight: 0,02 kg</i>
--	---

Entrance connector with lid - for sensors



Code: S0988 6-pin connector - male - for sensors TSV, TK, TV and TS - for control unit AC07X	<i>Price:</i> <i>Weight: 0,02 kg</i>
---	---

Burner connector with lid - supply - power



Code: S0991 connector - female for cabel 6-pin - for control unit (AC07X)	<i>Price:</i> <i>Weight: 0,02 kg</i>
---	---

Code: S0739 connecting cable between boiler and burner - 2,5 m - complete with connectors type S0985 and S0991	<i>Price:</i> <i>Weight: 0,52 kg</i>
---	---

Burner connector with bushing - for sensors

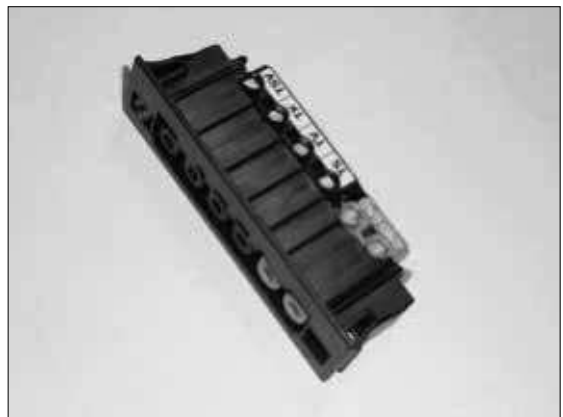

Code: S0987 6-pin connector with bushing - female - for sensors TSV, TK, TV and TS - for control unit AC07X	<i>Price:</i> <i>Weight: 0,02 kg</i>
--	---

Socket for the external conveyor



Code: H0211 socket for the external conveyor

Price:

Weight: 0,05 kg

Closing lid



Code: S0509 intended for closing the air entrance when burning wood in boiler types DC15EP, DC18SP, DC25SP, DC32SP – for burners ATMOS A25 and IWABO VILLA S1

Price:

Weight: 0,20 kg

Grommet



Code: S1191 spare grommet

Price:

Weight: 0,01 kg

Set for reduction of pipes diameter Ø 65 / Ø 75 mm



Code: S0993 set for reduction of hoses diameter for A25 / A45 - Ø 65 / Ø 75 mm

Price:

Weight: 0,65 kg

Cleaning rake - small



Code: V0346 fire hook for cleaning burning chamber of the burner A25 or A45 - small

Price:

Weight: 0,12 kg

Special parts for A25 pellet burner
 - in a version for DCxxGSP boiler
 - in a version for DCxxSP, CxxSP boilers - Model 2018 (from serial nr. 343500)



Complete air flap for closing of pellet burner when burning wood



Code: H0420 complete air flap for closing of pellet burner when burning wood in boilers DCxxGSP, DCxxSP, CxxSP - Model 2018	<i>Price:</i>
	<i>Weight: 1,60 kg</i>

Shaft sealing for air flap



Code: S1053 shaft sealing for air flap	<i>Price:</i>
	<i>Weight: 0,01 kg</i>

Actuator for burner flap

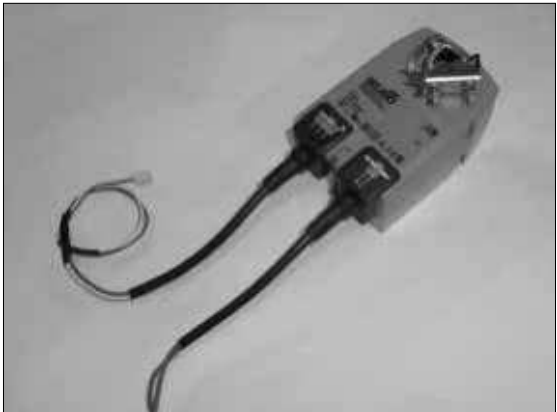

Code: P0074 actuator for closing A25 burner flap - for boilers GSP, SP - 2018	<i>Price:</i>
	<i>Weight: 0,56 kg</i>

Air flap sealing



Code: S1051 air flap inner sealing between burner and intermediate flange	<i>Price:</i>
	<i>Weight: 0,01 kg</i>

Sealing between flap and burner

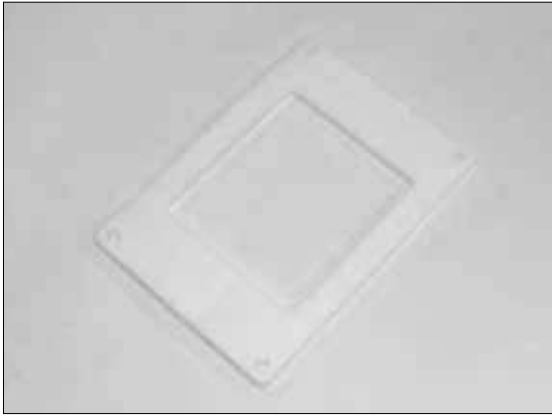

Code: S1052 sealing between flap and burner

Price:
Weight: 0,01 kg

AD04 module



Code: P0446 burner module for special functions

Price:
Weight: 0,10 kg

R3 and R4 connector for burner

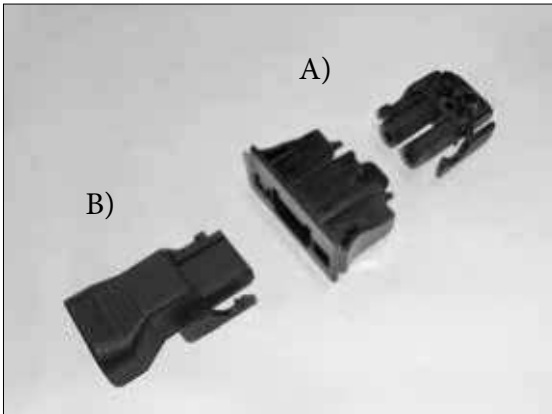

Code: S1090 A) female connector with bushing in to burner for R3 and R4 support outputs of ventilator - for burner

Price:
Weight: 0,01 kg

Code: S1091 B) male connector for cable

Price:
Weight: 0,01 kg

Electric wiring of the burner A25 - GSP, SP - 2018



Code: H0233 electric wiring of the burner, incl. bushings and connectors - AC07X (GSP)

Price:
Weight: 1,10 kg

R3 and R4 connecting cable for boilers DCxxGSP



Code: S1084 additional connecting cable with 2-pin connectors (S1091 and S1093) R3 and R4 between boiler and burner

Price:
Weight: 0,16 kg

Burner cover - A25 - hood with a window for display



Code: H0421 A25 burner cover - blue DCxxGSP

Price:
Weight: 2,09 kg

Code: H0423 A25 burner cover - red DCxxSP, CxxSP - Model 2018

Price:
Weight: 2,09 kg

Parts for pneumatic cleaning of the ATMOS A25 pellet burner

(for pellet burners from serial nr. 05627 (04/2013))



Holder - plate with openings for the ignition spirals - for pneumatic cleaning

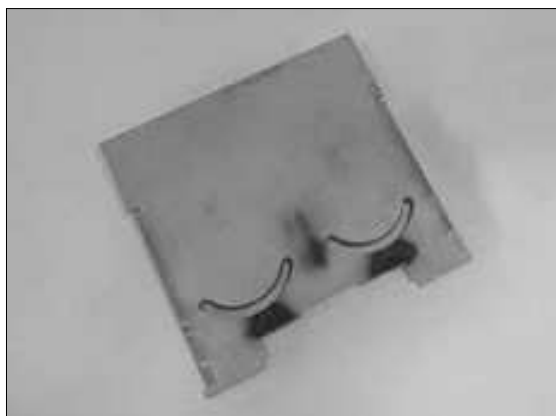

Code: H0277 holder - plate with openings for the ignition spirals - for burner with pneumatic cleaning	<i>Price:</i>
	<i>Weight:</i> 1,00 kg

Combustion chamber (pot) of the burner - for pneumatic cleaning

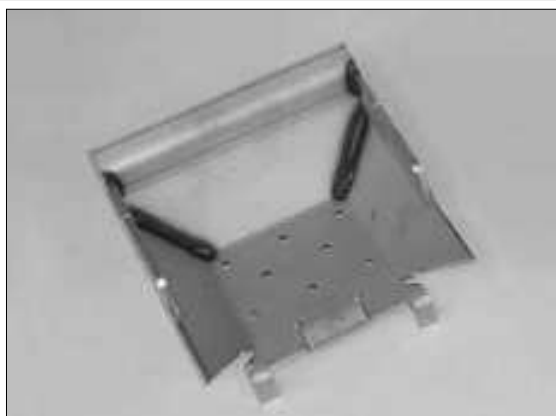

Code: H0276 spare combustion chamber (pot) of the burner with pneumatic cleaning	<i>Price:</i>
	<i>Weight:</i> 0,92 kg

Pneumatic cleaning duct



Code: H0533 pneumatic cleaning duct with locking nut and washer	<i>Price:</i>
	<i>Weight:</i> 1,32 kg

Electromagnetic valve of the pneumatic cleaning



Code: S1078 complete fittings (3/4") with control electro-valve - A85	<i>Price:</i>
	<i>Weight:</i> 1,48 kg
Code: S1062 electro-valve	<i>Price:</i>
	<i>Weight:</i> 0,93 kg

Connecting air hose for pneumatic cleaning



Code: S0767 connecting air hose between burner and compressor - 1 m (Ø 28 mm)	<i>Price:</i>
	<i>Weight:</i> 1,10 kg
Code: S0768 connecting air hose between burner and compressor - 1,5 m (Ø 28 mm)	<i>Price:</i>
	<i>Weight:</i> 1,36 kg

Burner body lid with gasket



Code: S0996 cover (lid) hole of burner body for pneumatic cleaning	<i>Price:</i>
	<i>Weight:</i> 0,10 kg
Code: S1031 gasket under cover (lid)	<i>Price:</i>
	<i>Weight:</i> 0,01 kg

Supply cable for compressor



Code: S0747 connecting cable with 3-pin connector (female) between compressor, boiler and socket on the wall	<i>Price:</i>
	<i>Weight:</i> 0,52 kg

Closing mechanism - slide valve



For gasification boilers with an in-built burner in the upper doors and pneumatic burner cleaner

Code: H0535 for boilers: DC18S, DC22S, DC25S, DC30SX, C18S, C20S, C25ST, C30S, C32ST, C40S, AC25S, AC35S, KC25S, KC35S, DC30RS	<i>Price:</i>
	<i>Weight:</i> 0,34 kg
Code: H0537 for boilers: DC30SE, DC32S, DC40SX, DC50S	<i>Price:</i>
	<i>Weight:</i> 0,36 kg

Compressor for pneumatic cleaning



Code: H0305 compressor (H2/6) for burner pneumatic cleaning - A25 and A45	<i>Price:</i>
	<i>Weight:</i> 19,00 kg
Code: H0325 oil-free compressor OLT (89/6) for pneumatic cleaning of the burner A25 and A45	<i>Price:</i>
	<i>Weight:</i> 19,00 kg
Code: H0576 hooded oil-free compressor OLT (89/6) for pneumatic cleaning of the burner A25 a A45 for boilers P14, P21, P25	<i>Price:</i>
	<i>Weight:</i> 28,20 kg
Code: S1598 hood for oil-free compressor OLT (89/6)	<i>Price:</i>
	<i>Weight:</i> 9,20 kg

Connector for the compressor



Code: S0647 connector for the compressor (male)	<i>Price:</i>
	<i>Weight:</i> 0,02 kg

Special grate (nozzle cover)



Code: H0534 special grate that prevents clogging of the DCxxS(X) gasification nozzle with sinter thrown from the combustion chamber	<i>Price:</i>
	<i>Weight:</i> 1,40 kg

8. ATMOS A45 pellet burner



Pellet burner - ATMOS A45



Code: H0015 burner - red - (8,5 - 49 kW)	<i>Price:</i>
	<i>Weight: 23,00 kg</i>
Code: H0238 fuse for ignitaton spiral – type F3.15A/1500A/5x20 mm – into the burner	<i>Price:</i>
	<i>Weight: 0,01 kg</i>
Code: H0239 fuse for ventilator or conveyor spiral – type F0.8A/1500A/5x20 mm	<i>Price:</i>
	<i>Weight: 0,01 kg</i>
Code: H0251 fuse for conveyor – type F1.0A/1500A/5x20 mm	<i>Price:</i>
	<i>Weight: 0,01 kg</i>

Electronic unit of the burner

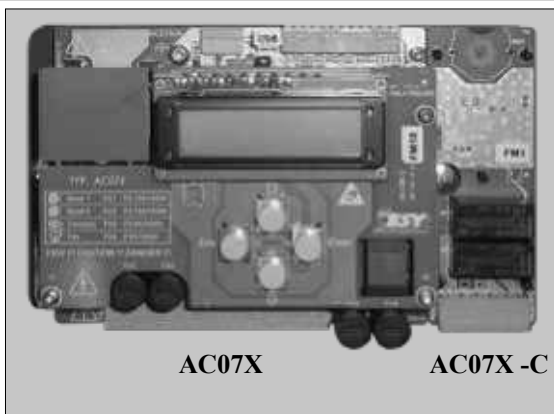

AC07X

AC07X - C

Code: H0222 spare electronic unit of the burner - AC07 (ACO7X - since 2012) from serial nr. 1375) with a fixation plate	<i>Price:</i>
	<i>Weight: 0,70 kg</i>
Code: H0310 electronic unit ACO7X + MC (Module C (AC07X - C)) with an enlarged fixation plate	<i>Price:</i>
	<i>Weight: 0,85 kg</i>
Code: H0337 additional module AC07X - C - (R5, R6) to control pneumatic cleaning system of burner or other aplications - separate	<i>Price:</i>
	<i>Weight: 0,10 kg</i>
Code: H0427 additional module AC07X - C - (R5, R6) with a holder for fixing on plate of electronic unit AC07X - since 2019	<i>Price:</i>
	<i>Weight: 0,14 kg</i>

Conveyors for burner ATMOS A45



Code: H0039 conveyor for burner with shaft DRA50 - 1,7 m (gearbox 40 W)	<i>Price:</i>
	<i>Weight: 17,00 kg</i>
Code: H0037 conveyor for burner with shaft DRA50 - 2,5 m (gearbox 40 W)	<i>Price:</i>
	<i>Weight: 23,00 kg</i>
Code: H0004 conveyor for burner with shaft DRA50 - 4 m (gearbox 40 W)	<i>Price:</i>
	<i>Weight: 36,80 kg</i>
Code: H0005 conveyor for burner with shaft DRA50 - 5 m (gearbox 40 W)	<i>Price:</i>
	<i>Weight: 40,00 kg</i>

Gearbox of the conveyor DRA50



Code: H0107 gearbox of the conveyor 25W - DRA50 - 1,7 a 2,5 m	<i>Price:</i>
	<i>Weight: 2,72 kg</i>
Code: H0159 gearbox of the conveyor 40W - DRA50 - 1,7 a 2,5 m	<i>Price:</i>
	<i>Weight: 4,50 kg</i>
Code: H0113 gearbox capacitor for conveyors DA a DRA	<i>Price:</i>
	<i>Weight: 0,06 kg</i>

Pellet supply hose



Code: H0175 spare pipe between burner and pellet conveyor - lenght 1 m and Ø 75 mm - transparent	<i>Price:</i>
	<i>Weight:</i> 0,78 kg
Code: H0304 hose clamp 70 - 90 mm	<i>Price:</i>
	<i>Weight:</i> 0,03 kg

Leg and collar for conveyors - type DRA



Code: H0416 collar – separate for conveyors DRA	<i>Price:</i>
	<i>Weight:</i> 0,20 kg
Code: H0415 leg for conveyor type DRA - for conveyors DRA1,7 m, DRA2,5 m, DRA4 m, DRA5 m and DA1500	<i>Price:</i>
	<i>Weight:</i> 2,10 kg

Spare bearing for conveyor



Code: V0104 bearing	<i>Price:</i>
	<i>Weight:</i> 0,12 kg
Code: V0105 pocket - 2 pcs	<i>Price:</i>
	<i>Weight:</i> 0,10 kg
Code: H0198 complete set - bearing + pocket - 2 pcs	<i>Price:</i>
	<i>Weight:</i> 0,22 kg

Spare auger with shaft for conveyor DRA50

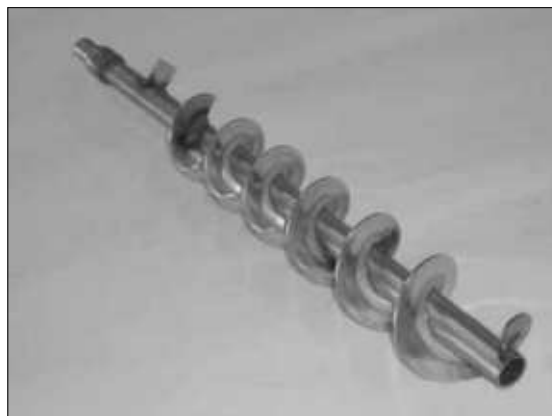

Code: H0007 spare auger for conveyor 1,7 m	<i>Price:</i>
	<i>Weight:</i> 4,41 kg
Code: H0008 spare auger for conveyor 2,5 m	<i>Price:</i>
	<i>Weight:</i> 6,26 kg
Code: H0009 spare auger for conveyor 4 m	<i>Price:</i>
	<i>Weight:</i> 8,45 kg
Code: H0010 spare auger for conveyor 5 m	<i>Price:</i>
	<i>Weight:</i> 10,28 kg

Spare tube of conveyor DRA50

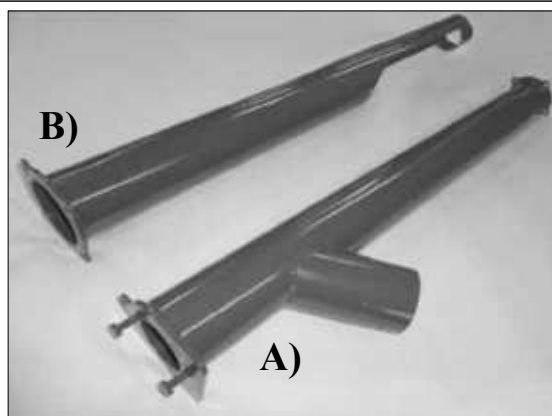

Code: H0267 spare tube of conveyor DRA50 - 1,7 m	<i>Price:</i>
	<i>Weight:</i> 5,87 kg
Code: H0268 spare tube of conveyor DRA50 - 2,5 m	<i>Price:</i>
	<i>Weight:</i> 8,19 kg
Code: H0269 spare tube of conveyor DRA50 - 4 m - part A)	<i>Price:</i>
	<i>Weight:</i> 6,65 kg
Code: H0270 spare tube of conveyor DRA50 - 4 m - part B)	<i>Price:</i>
	<i>Weight:</i> 6,22 kg
Code: H0271 spare tube of conveyor DRA50 - 5 m - part A)	<i>Price:</i>
	<i>Weight:</i> 8,09 kg
Code: H0272 spare tube of conveyor DRA50 - 5 m - part B)	<i>Price:</i>
	<i>Weight:</i> 7,66 kg

Parts for connectin of the conveyor gearbox



Code: V0139 flange for conveyor gearbox - DRA	<i>Price:</i>
	<i>Weight: 0,28 kg</i>
Code: V0529 locking pivot	<i>Price:</i>
	<i>Weight: 0,03 kg</i>
Code: V0140 locking brace for conveyer - DRA	<i>Price:</i>
	<i>Weight: 0,03 kg</i>

Top cover of the burner mouth

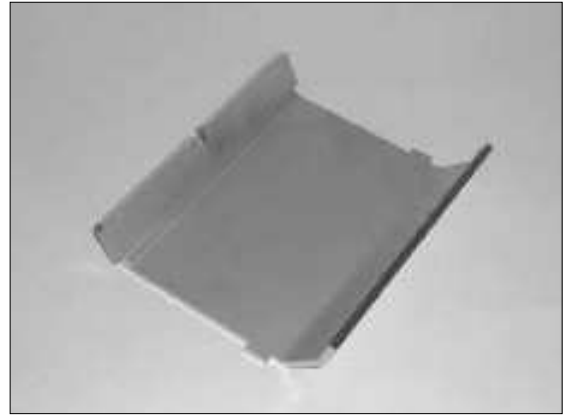

Code: H0404 top cover of the burner mouth - A45	<i>Price:</i>
	<i>Weight: 1,48 kg</i>

Combustion chamber (pot) of the burner

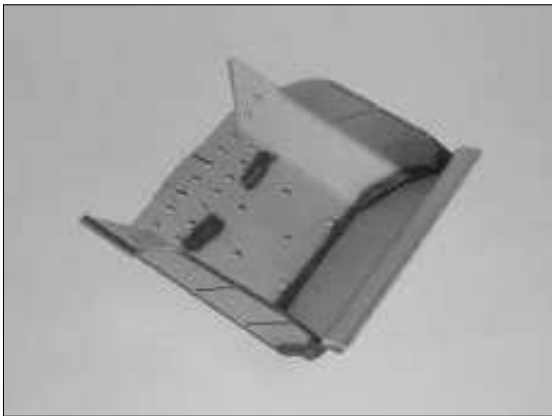

Code: H0410 spare combustion chamber (pot) of the burner - A45	<i>Price:</i>
	<i>Weight: 2,00 kg</i>

Inner holder of the ignition spiral

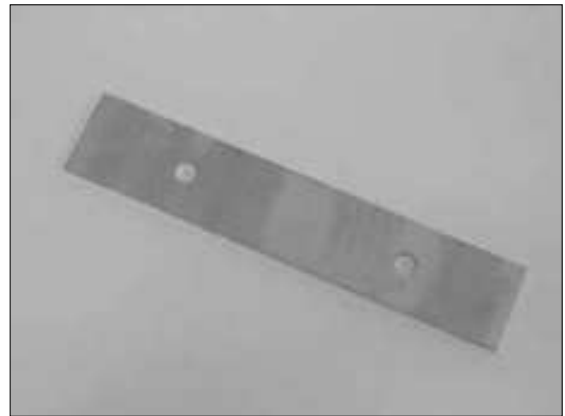

Code: H0409 inner holder of the ignition spiral	<i>Price:</i>
	<i>Weight: 0,14 kg</i>

Holder - plate with openings for the ignition spirals



Code: H0407 holder - plate with openings for the ignition spirals - A45	<i>Price:</i>
	<i>Weight: 1,26 kg</i>

Ignition spiral cover

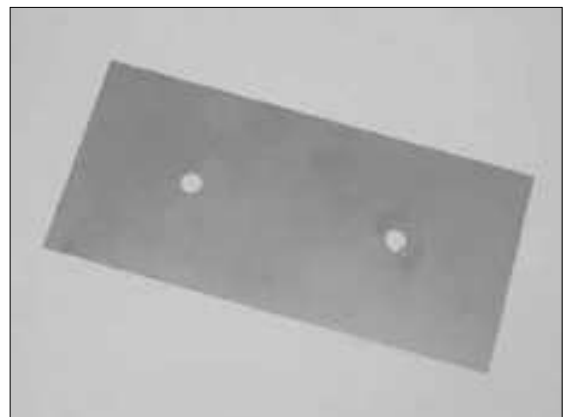

Code: H0408 ignition spiral cover	<i>Price:</i>
	<i>Weight: 0,10 kg</i>

Pellet supply pipe



Code: H0406 pellet supply pipe

Price:

Weight: 0,72 kg

Fan with a speed sensor and with air flap



Code: H0041 spare fan with a speed sensor
and with air flap

Price:

Weight: 2,04 kg

Gasket under the flange of the pellet supply pipe



Code: S0181 gasket under the flange of the
pellet supply pipe - sibril paper

Price:

Weight: 0,01 kg

Gasket under the fan - A45

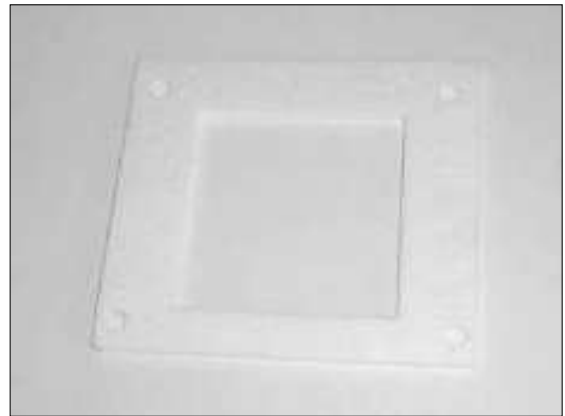

Code: S0157 gasket under the flange of the
burner fan - A45 - 84 x 94 mm

Price:

Weight: 0,01 kg

End switch stop



Code: H0412 end switch stop

Price:

Weight: 0,07 kg

Air flap of the fan



Code: H0441 air flap of the fan

Price:

Weight: 0,16 kg

Ignition spiral



Code: H0229 spare ignition spiral 500W	<i>Price:</i>
	<i>Weight: 0,18 kg</i>
Code: H0108 spare cable for ignition spirals	<i>Price:</i>
	<i>Weight: 0,04 kg</i>

Holder of the electronic unit

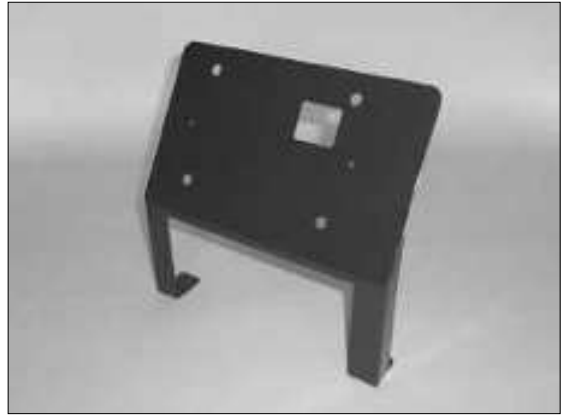

Code: H0405 holder of the electronic unit	<i>Price:</i>
	<i>Weight: 0,54 kg</i>

Safety thermostat cover



Code: H0224 safety thermostat cover	<i>Price:</i>
	<i>Weight: 0,05 kg</i>

Burner cover - A45 - hood with a window for display

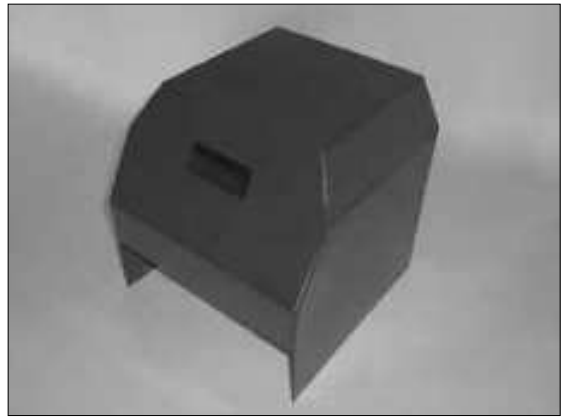

Code: H0403 burner cover - hood with a window for the display	<i>Price:</i>
	<i>Weight: 1,76 kg</i>
Code: H0413 burner cover - red - hood with a window for the display - model (AC07X)	<i>Price:</i>
	<i>Weight: 1,76 kg</i>
Code: H0422 burner cover - blue - hood with a window for the display - model (AC07X)	<i>Price:</i>
	<i>Weight: 1,76 kg</i>

Safety thermostat 95 °C



Code: H0059 safety thermostat to burner supply pipe (two possible types) - can be changed	<i>Price:</i>
	<i>Weight: 0,02 kg</i>

Display self-sticking label

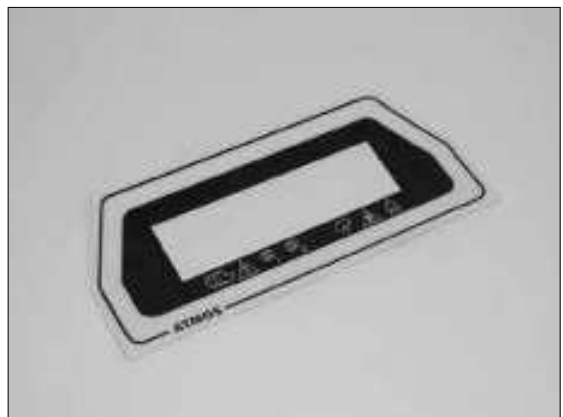

Code: H0236 display self-sticking label	<i>Price:</i>
	<i>Weight: 0,01 kg</i>

Electric wiring of the burner

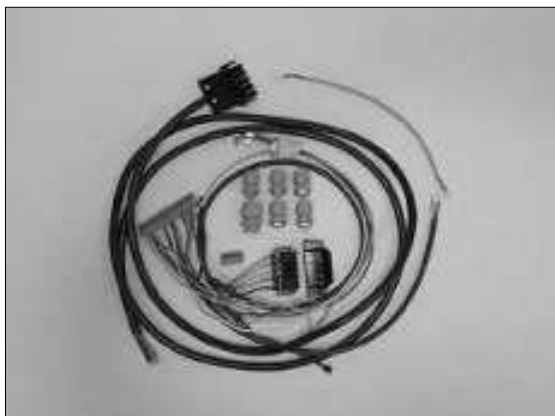

Code: H0216 electric wiring of the burner, incl. bushings and connectors - AC07 *Price:*
Weight: 1,00 kg

Code: H0216 electric wiring of the burner, incl. bushings and connectors - AC07X *Price:*
Weight: 1,10 kg

AC07 electronic unit connector (1 - 16) PIN – bottom

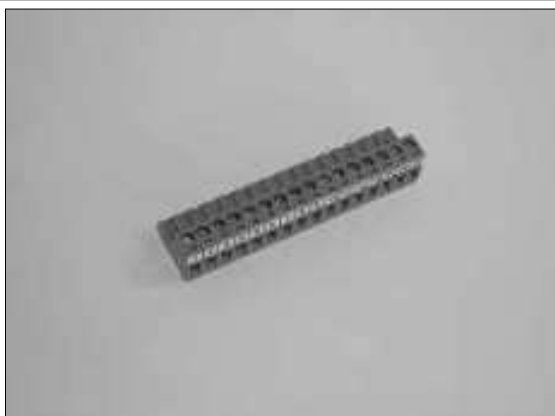

Code: H0234 electronic unit connector (1 - 16) PIN – bottom *Price:*
Weight: 0,03 kg

AC07 and AC07X electronic unit connector

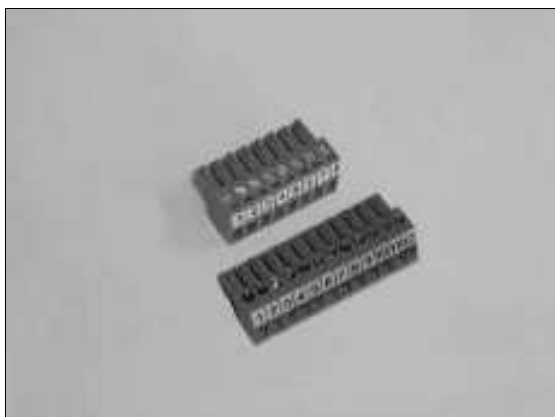

Code: H0235 electronic unit connector (1 - 8) - top for unit AC07 *Price:*
Weight: 0,01 kg

Code: H0260 electronic unit connector (1 - 12) - top for unit AC07X *Price:*
Weight: 0,01 kg

Photocell

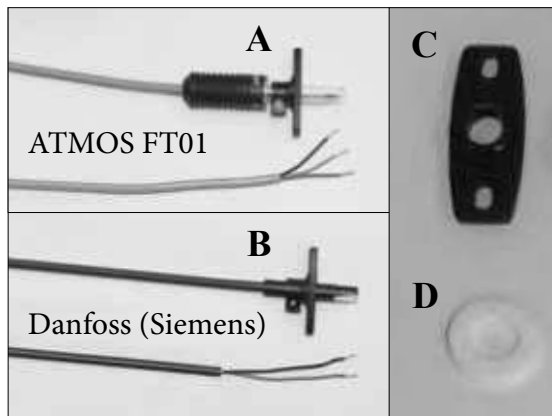

Code: H0330 spare photocell – stand alone *Price:*
ATMOS FT01 - for unit AC07X *Weight:* 0,05 kg
- with power supply - the polarity of the wires must be observed

Code: H0331 A - spare photocell *Price:*
– komplet ATMOS FT01 + holder *Weight:* 0,07 kg

Code: H0231 spare photocell – stand alone *Price:*
Danfoss (Siemens) - for unit AC07 *Weight:* 0,03 kg

Code: H0055 B - spare photocell *Price:*
– complete Danfoss (Siemens) + holder *Weight:* 0,07 kg

Code: H0232 C - photocell holder *Price:*
Weight: 0,02 kg

Code: S0155 D - photocell seal *Price:*
Weight: 0,01 kg

The connecting cable for the fan speed sensing



Code: H0109 the connecting cable for the fan speed sensing *Price:*
Weight: 0,05 kg

End switch of the burner



Code: H0210 end switch of the burner – FR501 *Price:*
Weight: 0,08 kg

Burner connector with lid - supply - power

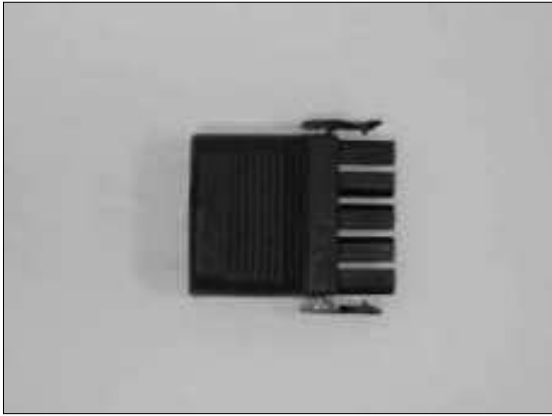

Code: S0902 connector (NAC 52S.B)
female with cabel – 5-pin

Price:
Weight: 0,44 kg

Burner connector with bushing - power

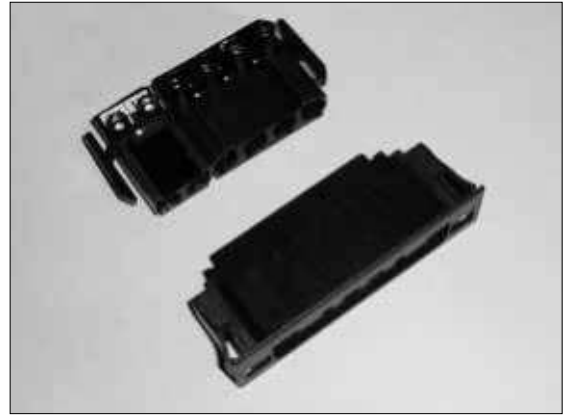

Code: S0989 connector - male – 6-pin
- for control unit (AC07X)

Price:
Weight: 0,02 kg

Burner connector with bushing - power

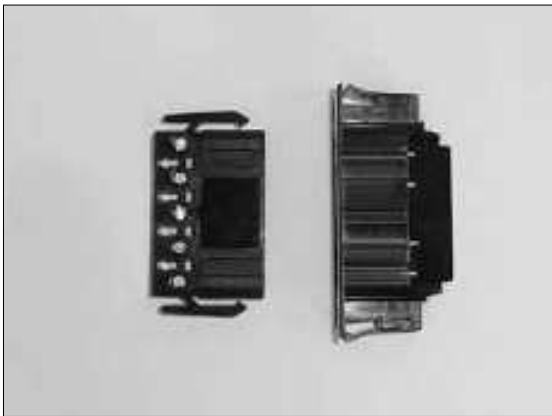

Code: S0914 connector (NAC 51.B) – male
with bushing – 5-pin

Price:
Weight: 0,02 kg

Entrance connector with lid - for sensors



Code: S0988 6-pin connector - male
- for sensors TSV, TK, TV and TS
- for control unit AC07X

Price:
Weight: 0,02 kg

Burner connector with lid - supply - power



Code: S0991 connector - female for cabel
6-pin - for control unit (AC07X)

Price:
Weight: 0,02 kg

Code: S0739 connecting cable between
boiler and burner - 2,5 m - complete
with connectors type S0985 and S0991

Price:
Weight: 0,52 kg

Burner connector with bushing - for sensors



Code: S0987 6-pin connector with
bushing - female - for sensors TSV,
TK, TV and TS - for control unit AC07X

Price:
Weight: 0,02 kg

Socket for the external conveyor



Code: H0211 socket for the external conveyor

Price:
Weight: 0,05 kg

Set for reduction of pipes diameter Ø 65 / Ø 75 mm



Code: S0993 set for reduction of pipes diameter for A25 / A45 - Ø 65 / Ø 75 mm

Price:
Weight: 0,65 kg

Grommet



Code: S1191 spare grommet

Price:
Weight: 0,01 kg

Cleaning fire hook - small



Code: V0346 fire hook for cleaning burning chamber of the burner A25 or A45 - small

Price:
Weight: 0,12 kg

Roof for conveyor DA a DRA



Code: H0275 it is roof for conveyor in pellet silo with pellet level more than 2 m

Price:
Weight: 3,60 kg

Parts for pneumatic cleaning of the ATMOS A45 pellet burner

(for pellet burners from serial nr. 00688 (04/2013))



Holder - plate with openings for the ignition spirals - for pneumatic cleaning

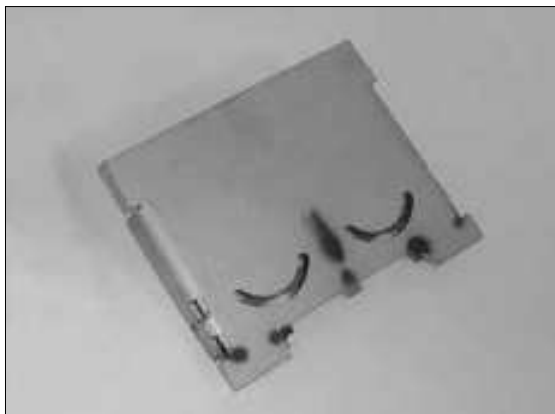

Code: H0417 holder - plate with openings for the ignition spirals - for burner with pneumatic cleaning

<i>Price:</i>
<i>Weight:</i> 1,16 kg

Pneumatic cleaning duct



Code: H0536 pneumatic cleaning duct with locking nut and washer

<i>Price:</i>
<i>Weight:</i> 1,74 kg

Combustion chamber (pot) of the burner - for pneumatic cleaning



Code: H0418 spare combustion chamber (pot) of the burner with pneumatic cleaning

<i>Price:</i>
<i>Weight:</i> 1,92 kg

Electromagnetic valve of the pneumatic cleaning



Code: S1078 complete fittings (3/4") with control electro-valve - A85

<i>Price:</i>
<i>Weight:</i> 1,48 kg

Code: S1062 electro-valve

<i>Price:</i>
<i>Weight:</i> 0,93 kg

Connecting air hose for pneumatic cleaning



Code: S0767 connecting air hose between burner and compressor - 1 m (Ø 28 mm) *Price:*
Weight: 1,10 kg

Code: S0768 connecting air hose between burner and compressor - 1,5 m (Ø 28 mm) *Price:*
Weight: 1,36 kg

Connector for the compressor



Code: S0647 connector for the compressor (male) *Price:*
Weight: 0,02 kg

Burner body lid with gasket



Code: S0996 cover (lid) hole of burner body for pneumatic cleaning *Price:*
Weight: 0,10 kg

Code: S1031 gasket under cover (lid) *Price:*
Weight: 0,01 kg

Supply cable for compressor



Code: S0747 connecting cable with 3-pin connector (female) between compressor, boiler and socket on the wall *Price:*
Weight: 0,52 kg

Compressor for pneumatic cleaning



Code: H0305 compressor (H2/6) for burner pneumatic cleaning - A25 and A45 *Price:*
Weight: 19,00 kg

Code: H0325 oil-free compressor OLT (89/6) for pneumatic cleaning of pellet burner A25 and A45 *Price:*
Weight: 19,00 kg

Closing mechanism - slide valve



For gasification boilers with an in-built burner in the upper doors and pneumatic burner cleaner

Code: H0535 for boilers: DC18S, DC22S, DC25S, DC30SX, C18S, C20S, C25ST, C30S, C32ST, C40S, AC25S, AC35S, KC25S, KC35S, DC30RS *Price:*
Weight: 0,34 kg

Code: H0537 for boilers: DC30SE, DC32S, DC40SX, DC50S *Price:*
Weight: 0,36 kg

9. ATMOS A85 pellet burner with pneumatic cleaning



ATMOS A85 pellet burner



Code: H0033 burner - red - (24 - 80 kW) with pneumatic cleaning	<i>Price:</i>
since 1.3. 2019 (s. n. 00258) with additional module ACO7X - C	<i>Weight:</i> 46,00 kg
Code: H0238 fuse for ignition spiral – type F3.15A/1500A/5x20 mm – into the burner	<i>Price:</i>
	<i>Weight:</i> 0,01 kg
Code: H0239 fuse for conveyor - type F0.8A/1500A/5x20 mm	<i>Price:</i>
	<i>Weight:</i> 0,01 kg
Code: H0251 fuse for fan – type F1.0A/1500A/5x20 mm	<i>Price:</i>
	<i>Weight:</i> 0,01 kg

Electronic unit of the burner

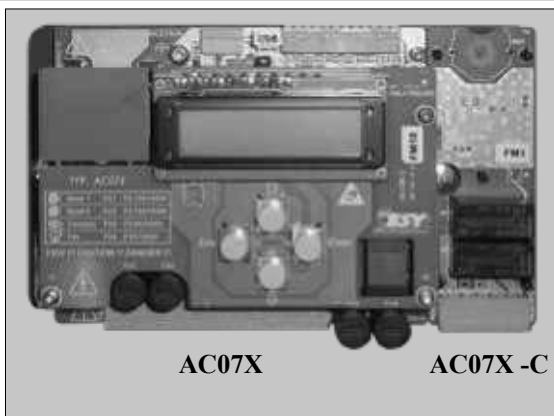

Code: H0222 spare electronic unit of the burner - AC07 (ACO7X - since 2012) from serial nr. 1375) with a fixation plate	<i>Price:</i>
	<i>Weight:</i> 0,70 kg
Code: H0310 electronic unit ACO7X + MC (Module C (AC07X - C)) with an enlarged fixation plate	<i>Price:</i>
	<i>Weight:</i> 0,85 kg
Code: H0337 additional module ACO7X - C - (R5, R6) to control pneumatic cleaning system of burner or other applications - separate	<i>Price:</i>
	<i>Weight:</i> 0,10 kg
Code: H0427 additional module ACO7X - C - (R5, R6) with a holder for fixing on plate of electronic unit AC07X - since 2019	<i>Price:</i>
	<i>Weight:</i> 0,14 kg

Conveyors for ATMOS A85 burner



Code: H0039 conveyor for burner with shaft DRA50 - 1,7 m (gearbox 40 W)	<i>Price:</i>
	<i>Weight:</i> 17,00 kg
Code: H0037 conveyor for burner with shaft DRA50 - 2,5 m (gearbox 40 W)	<i>Price:</i>
	<i>Weight:</i> 23,00 kg
Code: H0004 conveyor for burner with shaft DRA50 - 4 m (gearbox 40 W)	<i>Price:</i>
	<i>Weight:</i> 36,80 kg
Code: H0005 conveyor for burner with shaft DRA50 - 5 m (gearbox 40 W)	<i>Price:</i>
	<i>Weight:</i> 40,00 kg

Gear box of the conveyor DRA50



Code: H0107 gearbox of the conveyor 25W - DRA50 - 1,7 a 2,5 m	<i>Price:</i>
	<i>Weight:</i> 2,72 kg
Code: H0159 gearbox of the conveyor 40W - DRA50 - 1,7 a 2,5 m	<i>Price:</i>
	<i>Weight:</i> 4,50 kg
Code: H0113 gearbox capacitor for conveyors DA a DRA	<i>Price:</i>
	<i>Weight:</i> 0,06 kg

Pellet supply hose



Code: H0175 spare pipe between burner and pellet conveyor - lenght 1 m and Ø 75 mm - transparent	<i>Price:</i>
	<i>Weight:</i> 0,78 kg
Code: H0304 hose clamp 70 - 90 mm	<i>Price:</i>
	<i>Weight:</i> 0,03 kg

Leg and collar for conveyors - type DRA



Code: H0416 collar – separate for conveyors DRA	<i>Price:</i>
	<i>Weight:</i> 0,20 kg
Code: H0415 leg for conveyor type DRA - for conveyors DRA1,7 m, DRA2,5 m, DRA4 m, DRA5 m and DA1500	<i>Price:</i>
	<i>Weight:</i> 2,10 kg

Spare bearing for conveyor



Code: V0104 bearing	<i>Price:</i>
	<i>Weight:</i> 0,12 kg
Code: V0105 pocket - 2 pcs	<i>Price:</i>
	<i>Weight:</i> 0,10 kg
Code: H0198 complete set - bearing + pocket - 2 pcs	<i>Price:</i>
	<i>Weight:</i> 0,22 kg

Spare auger with shaft for conveyor DRA50

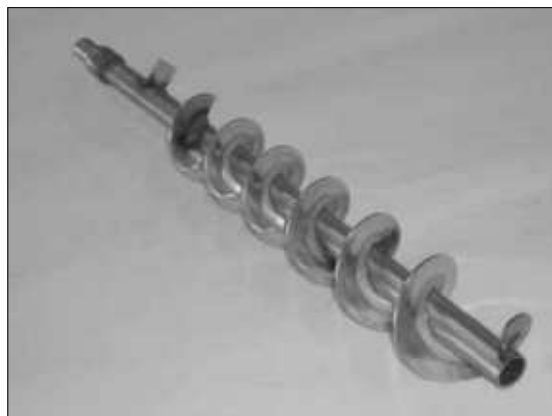

Code: H0007 spare auger for conveyor 1,7 m	<i>Price:</i>
	<i>Weight:</i> 4,41 kg
Code: H0008 spare auger for conveyor 2,5 m	<i>Price:</i>
	<i>Weight:</i> 6,26 kg
Code: H0009 spare auger for conveyor 4 m	<i>Price:</i>
	<i>Weight:</i> 8,45 kg
Code: H0010 spare auger for conveyor 5 m	<i>Price:</i>
	<i>Weight:</i> 10,28 kg

Spare tube of conveyor DRA50

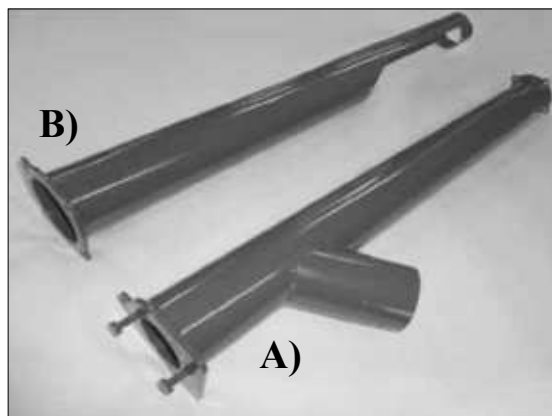

Code: H0267 spare tube of conveyor DRA50 - 1,7 m	<i>Price:</i>
	<i>Weight:</i> 5,87 kg
Code: H0268 spare tube of conveyor DRA50 - 2,5 m	<i>Price:</i>
	<i>Weight:</i> 8,19 kg
Code: H0269 spare tube of conveyor DRA50 - 4 m - part A)	<i>Price:</i>
	<i>Weight:</i> 6,65 kg
Code: H0270 spare tube of conveyor DRA50 - 4 m - part B)	<i>Price:</i>
	<i>Weight:</i> 6,22 kg
Code: H0271 spare tube of conveyor DRA50 - 5 m - part A)	<i>Price:</i>
	<i>Weight:</i> 8,09 kg
Code: H0272 spare tube of conveyor DRA50 - 5 m - part B)	<i>Price:</i>
	<i>Weight:</i> 7,66 kg

Parts for connectin of the conveyor gearbox



Code: V0139 flange for conveyor gearbox - DRA	<i>Price:</i>
	<i>Weight: 0,28 kg</i>
Code: V0529 locking pivot	<i>Price:</i>
	<i>Weight: 0,03 kg</i>
Code: V0140 locking brace for conveyer - DRA	<i>Price:</i>
	<i>Weight: 0,03 kg</i>

Top cover of the burner mouth

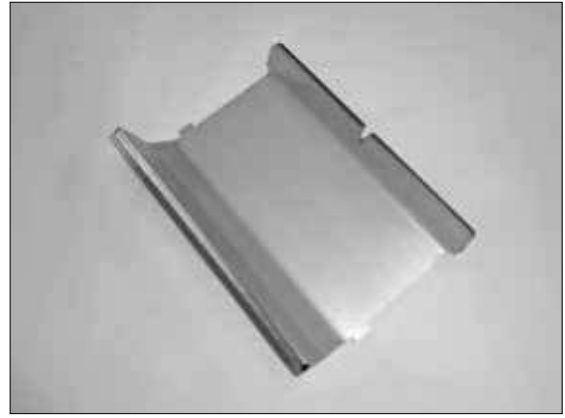

Code: H0430 top cover of the burner mouth - A85	<i>Price:</i>
	<i>Weight: 2,59 kg</i>

Combustion chamber (pot) of the burner

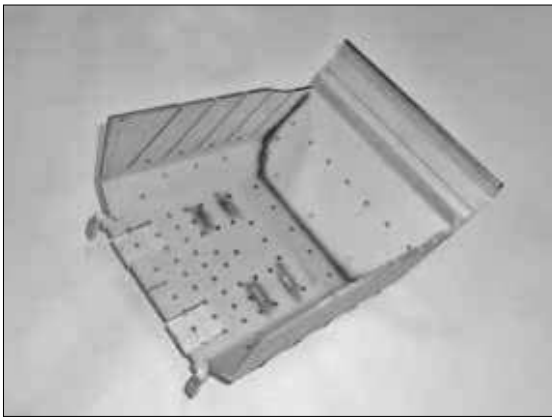

Code: H0431 spare combustion chamber (pot) of the burner - A85	<i>Price:</i>
	<i>Weight: 5,25 kg</i>

Inner holder of the ignition spiral

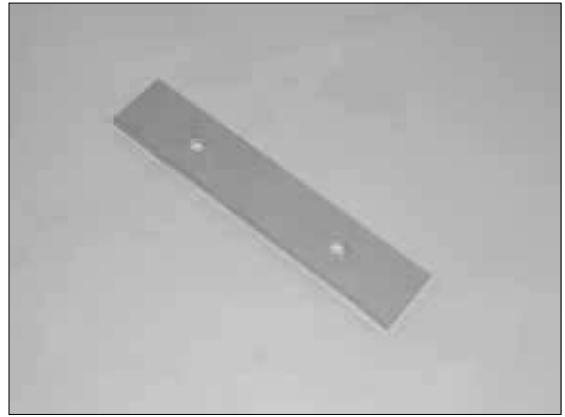

Code: H0432 inner holder of the ignition spiral	<i>Price:</i>
	<i>Weight: 0,18 kg</i>

Holder - plate with openings for the ignition spirals

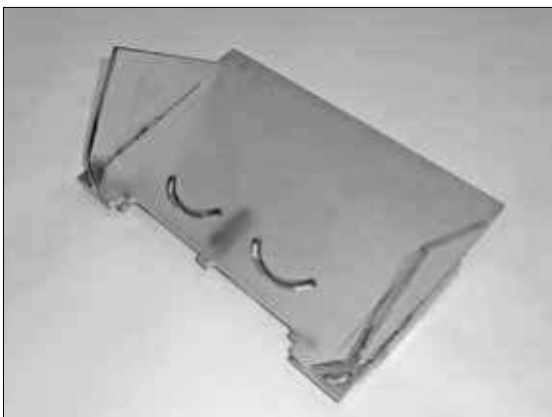

Code: H0433 holder - plate with openings for the ignition spirals - A85	<i>Price:</i>
	<i>Weight: 2,25 kg</i>

Ignition spiral cover

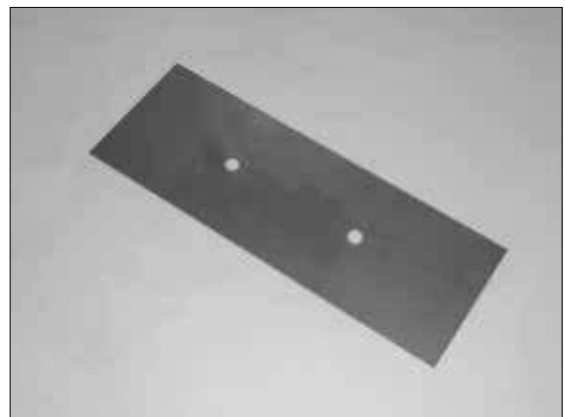

Code: H0434 ignition spiral cover	<i>Price:</i>
	<i>Weight: 0,14 kg</i>

Pellet supply pipe



Code: H0406 pellet supply pipe

Price:

Weight: 0,72 kg

Fan with a speed sensor and with air flap



Code: H0043 spare fan with a speed sensor and with air flap

Price:

Weight: 2,08 kg

Code: S0173 spare starting capacitor for burner fan - 2 μ F

Price:

Weight: 0,06 kg

Gasket under flange of pellet supply pipe - A45/85



Code: S0181 gasket under the flange of the pellet supply pipe - sibral paper

Price:

Weight: 0,01 kg

Capacitor for burner fan



Code: S0173 starting capacitor for burner fan - 2 μ F

Price:

Weight: 0,06 kg

Air flap of the fan

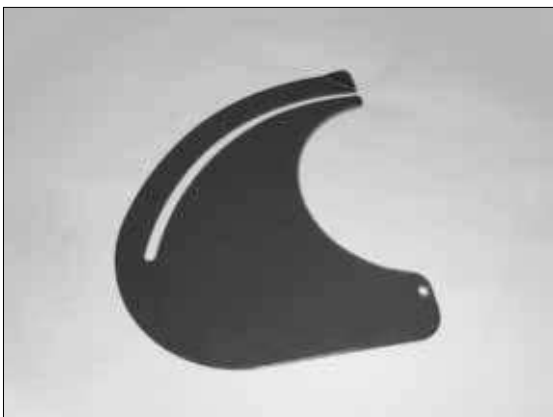

Code: H0435 air flap of the fan

Price:

Weight: 0,21 kg

Gasket under the fan - A85

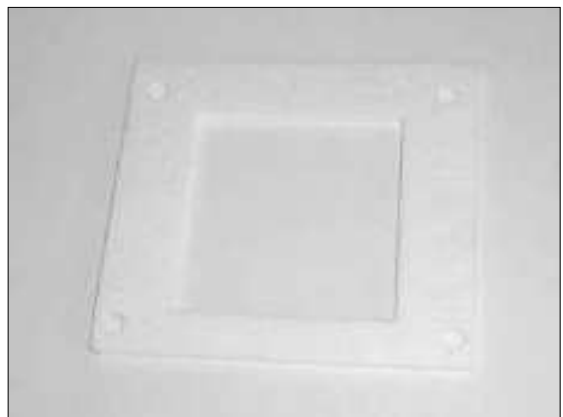

Code: S1058 gasket under the flange of the burner fan - A85 - 93 x 95 mm

Price:

Weight: 0,01 kg

Ignition spiral



Code: H0229 spare ignition spiral 500W	<i>Price:</i>
	<i>Weight: 0,18 kg</i>
Code: H0108 spare cable for ignition spirals	<i>Price:</i>
	<i>Weight: 0,04 kg</i>

Holder of the electronic unit

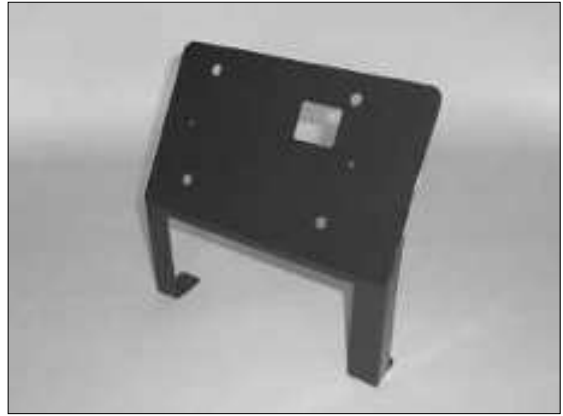

Code: H0405 holder of the electronic unit	<i>Price:</i>
	<i>Weight: 0,54 kg</i>

Safety thermostat cover



Code: H0224 safety thermostat cover	<i>Price:</i>
	<i>Weight: 0,05 kg</i>

Burner cover - A85 - hood with a window for display

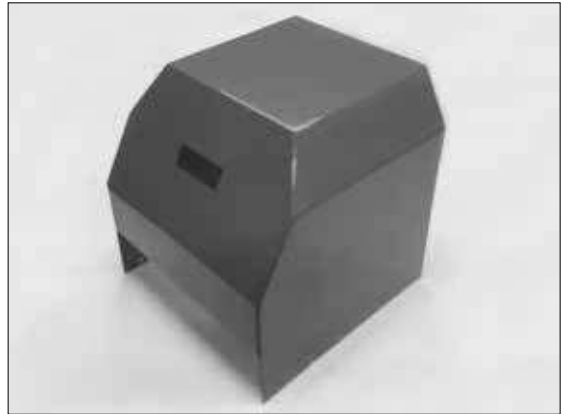

Code: H0436 burner cover - hood with a space for display - model 2012 (AC07X)	<i>Price:</i>
	<i>Weight: 2,60 kg</i>

Safety thermostat 95 °C



Code: H0059 safety thermostat to burner supply pipe (two possible types) - can be changed	<i>Price:</i>
	<i>Weight: 0,02 kg</i>

Display sticker

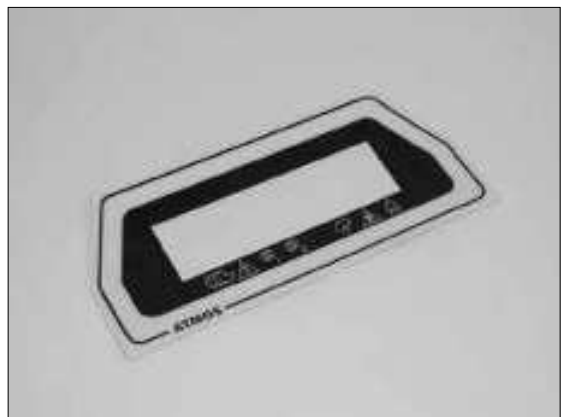

Code: H0236 display sticker	<i>Price:</i>
	<i>Weight: 0,01 kg</i>

Electric wiring of the burner A85

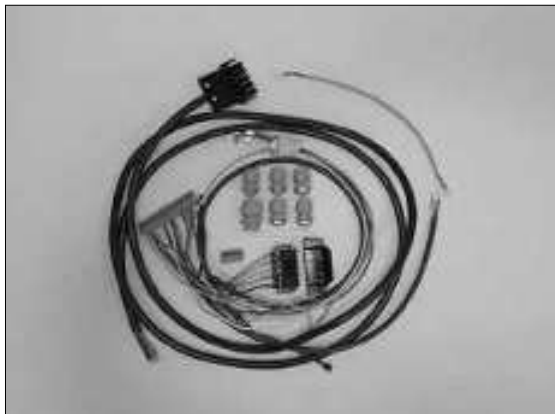

Code: H0265 electric wiring of the burner, incl. bushings and connectors - AC07X

<i>Price:</i>
<i>Weight:</i> 1,10 kg

AC07 electronic unit connector (1 - 16) PIN – bottom



Code: H0234 electronic unit connector (1 - 16) PIN – bottom

<i>Price:</i>
<i>Weight:</i> 0,03 kg

AC07X electronic unit connector

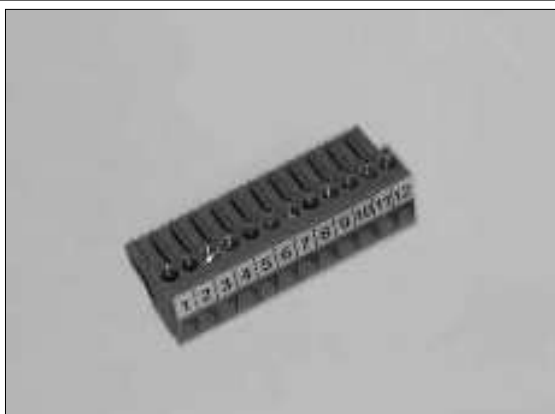

Code: H0260 electronic unit connector (1 - 12) - top for unit AC07X

<i>Price:</i>
<i>Weight:</i> 0,01 kg

Photocell

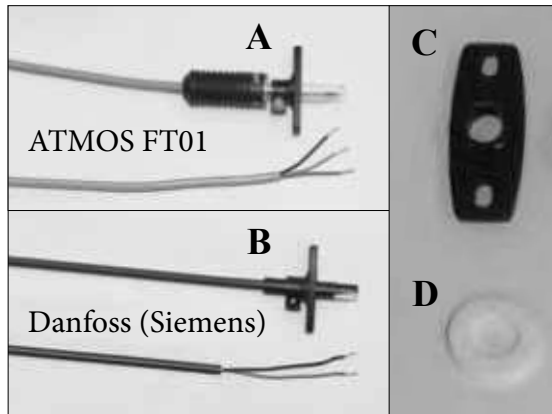

Code: H0330 spare photocell – stand alone ATMOS FT01 - for unit AC07X - with power supply - the polarity of the wires must be observed	<i>Price:</i>
	<i>Weight:</i> 0,05 kg
Code: H0331 A - spare photocell – komplet ATMOS FT01 + holder	<i>Price:</i>
	<i>Weight:</i> 0,07 kg
Code: H0231 spare photocell – stand alone Danfoss (Siemens) - for unit AC07	<i>Price:</i>
	<i>Weight:</i> 0,03 kg
Code: H0055 B - spare photocell – complete Danfoss (Siemens) + holder	<i>Price:</i>
	<i>Weight:</i> 0,07 kg
Code: H0232 C - photocell holder	<i>Price:</i>
	<i>Weight:</i> 0,02 kg
Code: S0155 D - photocell seal	<i>Price:</i>
	<i>Weight:</i> 0,01 kg

The connecting cable for the fan speed sensing



Code: H0109 the connecting cable for the fan speed sensing for burner

<i>Price:</i>
<i>Weight:</i> 0,05 kg

End switch stop



Code: H0437 end switch stop for A85 pellet burner

<i>Price:</i>
<i>Weight:</i> 0,07 kg

End switch of the burner



Code: H0210 end switch of the burner – FR501	<i>Price:</i>
	<i>Weight:</i> 0,08 kg

Burner connector with bushing - for sensors

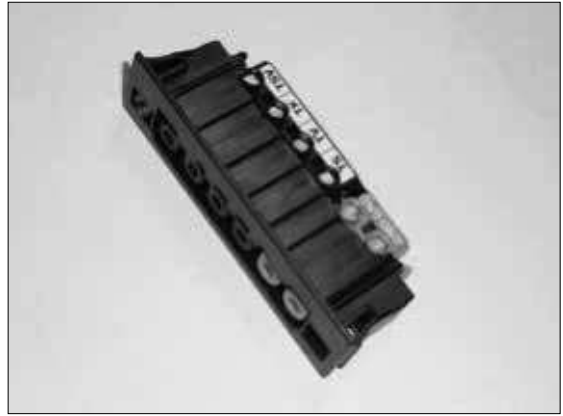

Code: S0987 6-pin connector with bushing - female - for sensors TSV, TK, TV and TS - for control unit AC07X	<i>Price:</i>
	<i>Weight:</i> 0,02 kg

Burner connector with lid - supply - power



Code: S0991 connector - female for cabel 6-pin - for control unit (AC07X)	<i>Price:</i>
	<i>Weight:</i> 0,02 kg
Code: S0739 connecting cable between boiler and burner - 2,5 m - complete with connectors type S0985 and S0991	<i>Price:</i>
	<i>Weight:</i> 0,52 kg

Entrance connector with lid - for sensors



Code: S0988 6-pin connector - male - for sensors TSV, TK, TV and TS - for control unit AC07X	<i>Price:</i>
	<i>Weight:</i> 0,02 kg

Burner connector with bushing - power



Code: S0989 connector - male – 6-pin - for control unit (AC07X)	<i>Price:</i>
	<i>Weight:</i> 0,02 kg

Connector for connection of speed sensor - A85

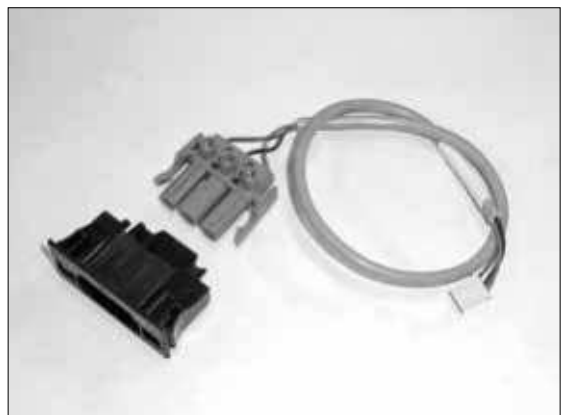

Code: S0662 3-pin connector - without cable - connecting cable for the exhaust fan speed sensing (UCJ4C82B) - boiler D80P, P80	<i>Price:</i>
	<i>Weight:</i> 0,02 kg
Code: S1094 3-pin connector - separate - without cable	<i>Price:</i>
	<i>Weight:</i> 0,01 kg

Socket for the external conveyor



Code: H0211 socket for the external conveyor

Price:
Weight: 0,05 kg

Cleaning fire hook - small



Code: V0346 fire hook for cleaning burning chamber of burner A25/A45/A85 - small

Price:
Weight: 0,12 kg

Module AD04



Code: P0446 burner module for special functions

Price:
Weight: 0,10 kg

Dilatation cover for burner chamber

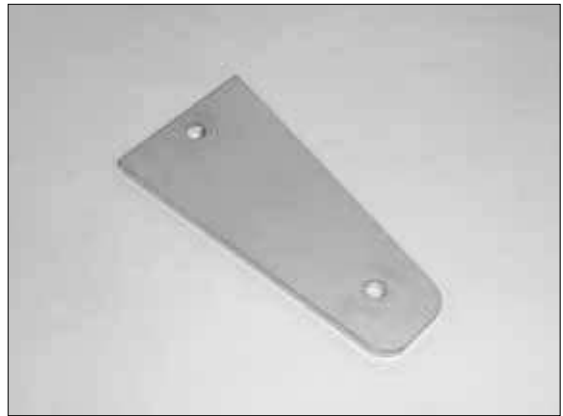

Code: H0438 dilatation cover for burner mouth (chamber) A85

Price:
Weight: 0,21 kg

Roof for conveyor DA a DRA



Code: H0275 it is roof for conveyor in pellet silo with pellet level more than 2 m

Price:
Weight: 3,60 kg

Shield for secondary air inlet



Code: H0439 shield for secondary air inlet for burner A85

Price:
Weight: 0,02 kg

Pneumatic cleaning duct



Code: H0440 pneumatic cleaning duct with locking nut and washer

<i>Price:</i>
<i>Weight:</i> 5,49 kg

Electromagnetic valve of the pneumatic cleaning



Code: S1078 complete fittings (3/4") with control electro-valve - A85	<i>Price:</i>
	<i>Weight:</i> 1,48 kg
Code: S1062 electro-valve	<i>Price:</i>
	<i>Weight:</i> 0,93 kg

Supply cable for compressor



Code: S0747 connecting cable with 3-pin connector (female) between compressor, boiler and socket on the wall

<i>Price:</i>
<i>Weight:</i> 0,52 kg

Connecting air hose for pneumatic cleaning



Code: S0767 connecting air hose between burner and compressor - 1 m (Ø 28 mm)	<i>Price:</i>
	<i>Weight:</i> 1,10 kg
Code: S0768 connecting air hose between burner and compressor - 1,5 m (Ø 28 mm)	<i>Price:</i>
	<i>Weight:</i> 1,36 kg

Connector for the compressor



Code: S0647 conector for the compressor (male)

<i>Price:</i>
<i>Weight:</i> 0,02 kg

Compressor for pneumatic cleaning - A85



Code: H0308 compressor (H2/24) for burner pneumatic cleaning - A85

<i>Price:</i>
<i>Weight:</i> 19,00 kg

10. IWABO pellet burner



Pellet burner - IWABO



Code: H0012 red color burner -(6 - 22 kW)	<i>Price:</i>
	<i>Weight:</i> 17,00 kg
Code: H0013 grey color burner -(6 - 22 kW)	<i>Price:</i>
	<i>Weight:</i> 17,00 kg
Code: H0022 pellet conveyor 1,5 m	<i>Price:</i>
	<i>Weight:</i> 10,00 kg
Code: H0032 pellet conveyor 2,5 m	<i>Price:</i>
	<i>Weight:</i> 14,00 kg
Code: H0060 fuse 6,3 A – into burner	<i>Price:</i>
	<i>Weight:</i> 0,01 kg
Code: H0061 fuse 2 A – into burner	<i>Price:</i>
	<i>Weight:</i> 0,01 kg

Photocell

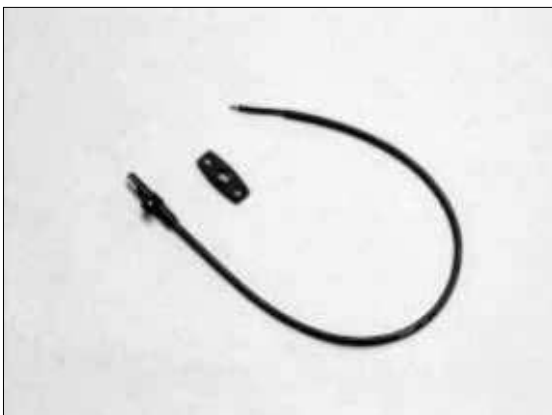

Code: H0055 spare photocell - complete (H0231 + H0232)	<i>Price:</i>
	<i>Weight:</i> 0,03 kg

Electronic unit PCB board IWABO



Code: H0051 electronic unit PCB board – old version till prod no.7899	<i>Price:</i>
	<i>Weight:</i> 0,20 kg
Code: H0064 electronic unit PCB – new from no. 7900 to prod. no. 15809	<i>Price:</i>
	<i>Weight:</i> 0,28 kg
Code: H0070 electronic unit PCB from prod no. 15810	<i>Price:</i>
	<i>Weight:</i> 0,28 kg
Code: H0242 set for change to the electronic unit ATMOS AC07X (AC07)	<i>Price:</i>
	<i>Weight:</i> 1,74 kg

Pellet supply hose



Code: H0066 spare pipe between burner and pellet conveyor - lenght 1 m and Ø 65 mm - transparent	<i>Price:</i>
	<i>Weight:</i> 0,68 kg
Code: H0302 hose clamp 60 - 80 mm	<i>Price:</i>
	<i>Weight:</i> 0,02 kg

Heating spiral



Code: H0052 heating spiral	<i>Price:</i>
	<i>Weight: 0,16 kg</i>
Code: H0108 connection wires for ignition spiral IWABO	<i>Price:</i>
	<i>Weight: 0,04 kg</i>

Blow fan

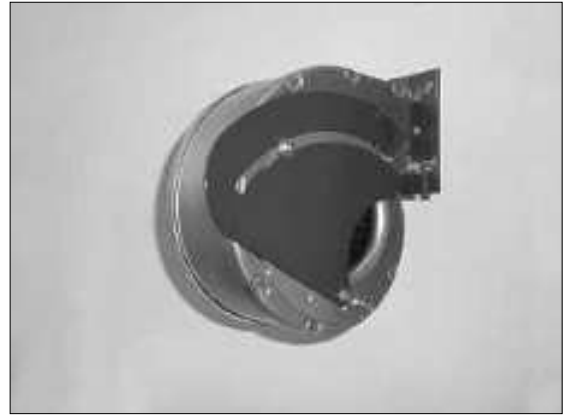

Code: H0058 blower fan with speed sensor for burners with production number from 15810 - replacement for fan H0056	<i>Price:</i>
	<i>Weight: 1,12 kg</i>

Combustion chamber (pot) of the burner

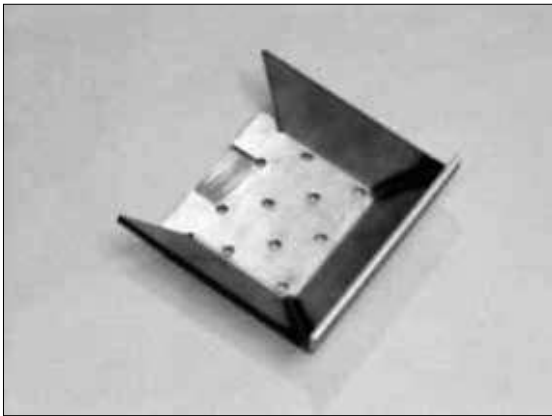

Code: H0053 spare combustion chamber (pot) of the burner	<i>Price:</i>
	<i>Weight: 0,80 kg</i>

Heating spiral cover

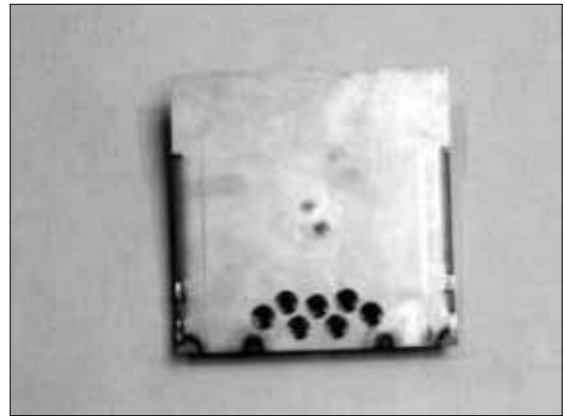

Code: H0062 heating spiral cover	<i>Price:</i>
	<i>Weight: 0,78 kg</i>

Safety thermostat 95 °C



Code: H0059 safety thermostat to burner supply pipe (two possible types) - can be changed	<i>Price:</i>
	<i>Weight: 0,02 kg</i>

Gear box of the conveyor- new version



Code: H0107 gearbox of the conveyor lenght 1,5 and 2,5 m - new version from 2006 - axle diameter 10 mm	<i>Price:</i>
	<i>Weight: 2,72 kg</i>

Relay with varistor

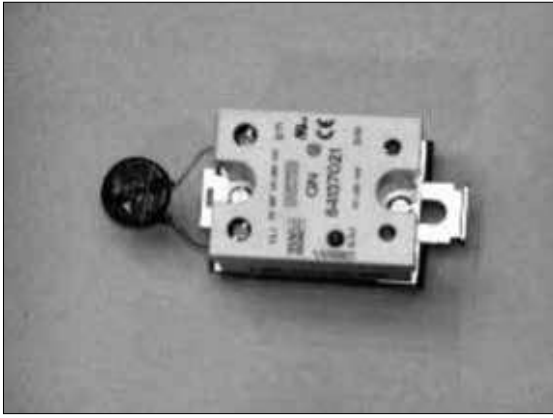

Code: H0057 spare part for replacing all old relays (blue, white etc.) – for old versions of the PCB boards of IWABO burners

Price:

Weight: 0,02 kg

L – part

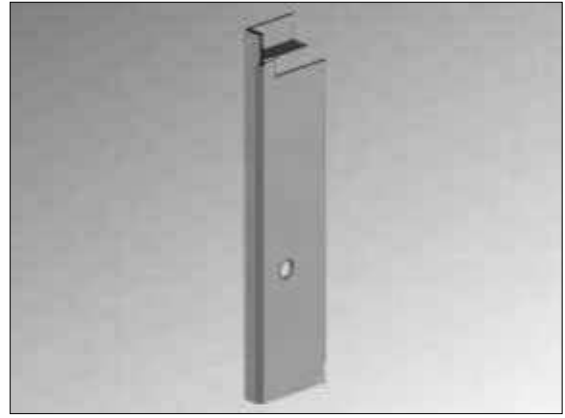

Code: S0454 for boilers D15P, D20P, DC15EP, DC18SP, DC25SP, DC32SP with pellet burner IWABO, as a stop for end switch

Price:

Weight: 0,14 kg

End-switch of the burner

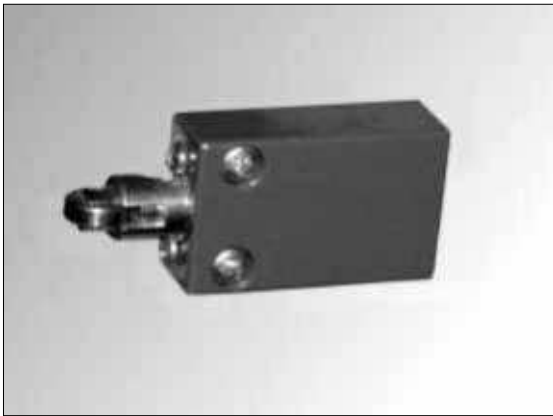

Code: H0065 end-switch of the burner

Price:

Weight: 0,34 kg

Closing flap



Code: S0509 intended for closing the air supply when heating with wood in boiler DC15EP, DC18SP, DC25SP, DC32SP – for burner ATMOS A25 and IWABO VILLA S1

Price:

Weight: 0,20 kg

11. ERATO GP20 pellet burner



Pellet burner - ERATO GP20



Code: H0016 red burner output (6-25 kW) —delivered with 2 m pellet conveyor, —included in the burner price	<i>Price:</i> <i>Weight:</i> 20,00 kg
---	--

Power converter



Code: H0028 new type power converter unit - interchangeable with the old version	<i>Price:</i> <i>Weight:</i> 0,28 kg
--	---

Electronic unit of the burner



Code: H0027 new version of the electronic unit - interchangeable with the old version	<i>Price:</i> <i>Weight:</i> 0,24 kg
---	---

Code: H0262 set for change to the electronic unit ATMOS AC07X (AC07)	<i>Price:</i> <i>Weight:</i> 1,20 kg
--	---

Set for change to the electronic unit ATMOS AC07X

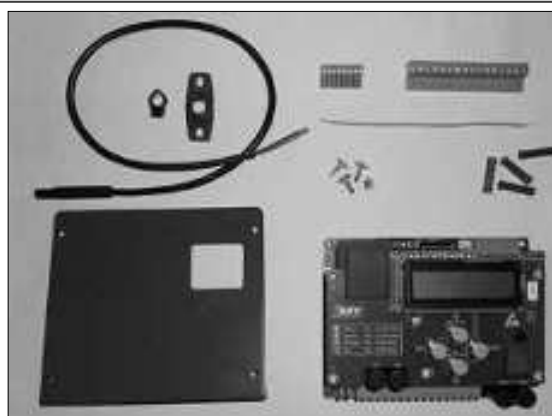

Code: H0262 set for change to the electronic unit ATMOS AC07X (AC07)	<i>Price:</i> <i>Weight:</i> 1,20 kg
--	---

Heating spirale

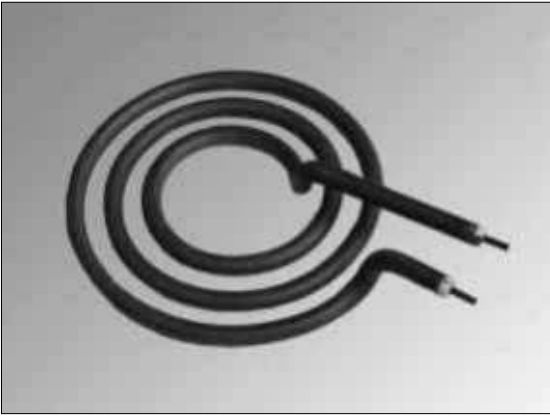

Code: H0020 spare heating spirale

Price:

Weight: 0,28 kg

Photocell with a rubber ring - old



Code: H0026 spare photocell - old

Price:

Weight: 0,15 kg

Heating spiral cover

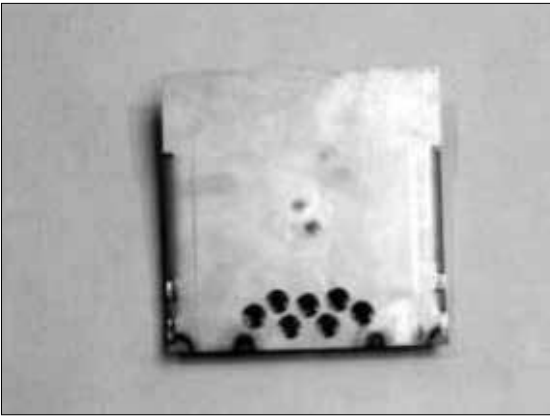

Code: H0024 heating spiral cover

Price:

Weight: 0,78 kg

Photocell - new



Code: H0231 spare photocell

Price:

Weight: 0,05 kg

Code: H0232 photocell holder

Price:

Weight: 0,02 kg

Code: H0055 photocell with holder - complete

Price:

Weight: 0,07 kg

Combustion chamber (pot) of the burner

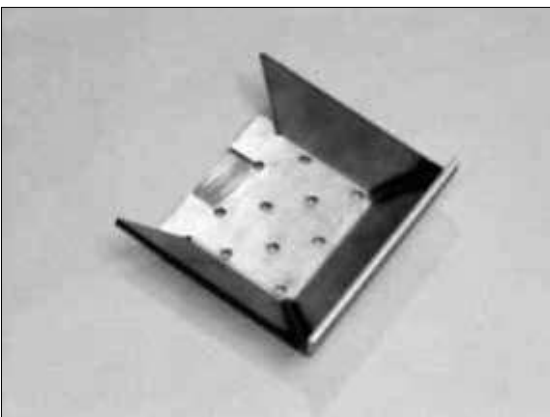

Code: H0054 spare combustion (pot) of the burner

Price:

Weight: 0,78 kg

Burner blower fan



Code: H0031 spare burner blower fan

Price:

Weight: 1,44 kg

Safety temperature thermostat – on the feeding pipe



Code: H0038 safety thermostat – on the feeding pipe – (2 types) – interchangeable with type H0059 – necessary to bent the connectors up!!!

<i>Price:</i>
<i>Weight:</i> 0,03 kg

Pellet supply hose



Code: H0066 spare pipe between burner and pellet conveyor - lenght 1 m and Ø 65 mm - transparent

<i>Price:</i>
<i>Weight:</i> 0,68 kg

Code: H0302 hose clamp 60 - 80 mm

<i>Price:</i>
<i>Weight:</i> 0,02 kg

End-switch of the burner



Code: H0030 end-switch of the burner

<i>Price:</i>
<i>Weight:</i> 0,34 kg

Pilot light



Code: H0190 spare pilot light – green

<i>Price:</i>
<i>Weight:</i> 0,01 kg

Code: H0191 spare pilot light – red

<i>Price:</i>
<i>Weight:</i> 0,01 kg

Code: H0192 spare pilot light – orange

<i>Price:</i>
<i>Weight:</i> 0,01 kg

Gearbox for conveyor – old version



Code: H0029 gearbox for conveyor 1,5 - 2 m

<i>Price:</i>
<i>Weight:</i> 1,46 kg

Connectors

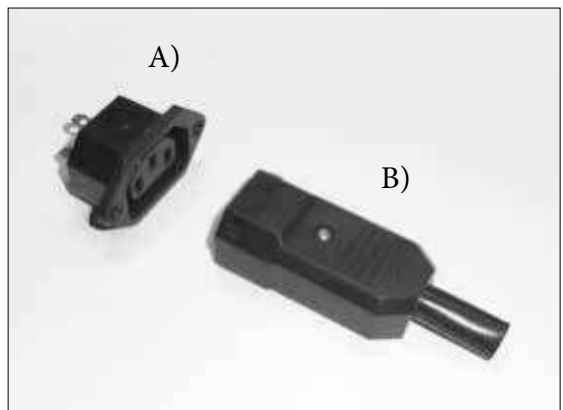

Code: H0193 A) connector - socket - female

<i>Price:</i>
<i>Weight:</i> 0,01 kg

Code: H0194 B) connector - plug - male

<i>Price:</i>
<i>Weight:</i> 0,02 kg

12. ATMOS A50 pellet burner



Pellet burner - ATMOS A50



Code: H0034 pellet burner - (13 - 48 kW)	<i>Price:</i>
	<i>Weight: 35,00 kg</i>
Code: H0025 pellet conveyor without shaft $\text{DA50} = 1,7\text{m}$	<i>Price:</i>
	<i>Weight: 16,50 kg</i>
Code: H0039 pellet conveyor with shaft DRA50 - 1,7m	<i>Price:</i>
	<i>Weight: 17,00 kg</i>
Code: H0037 pellet conveyor with shaft DRA50 - 2,5m	<i>Price:</i>
	<i>Weight: 23,00 kg</i>

Elektronik unit PCB board



Code: H0131 new electronic unit PCB board	<i>Price:</i>
	<i>Weight: 1,58 kg</i>

Photocell

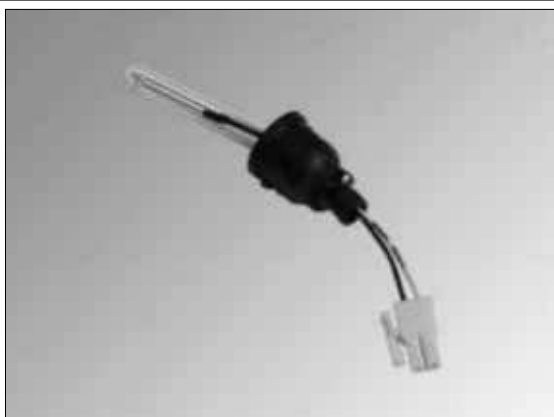

Code: H0130 spare photocell	<i>Price:</i>
	<i>Weight: 0,02 kg</i>

Pellet supply hose



Code: H0196 spare hose between burner and pellet conveyor - length 1 m and $\text{Ø} 73 \text{ mm}$ - non-transparent	<i>Price:</i>
	<i>Weight: 0,68 kg</i>

Pot – combustion chamber

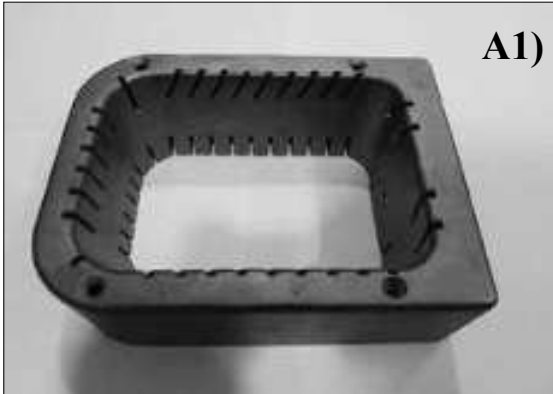

A1)

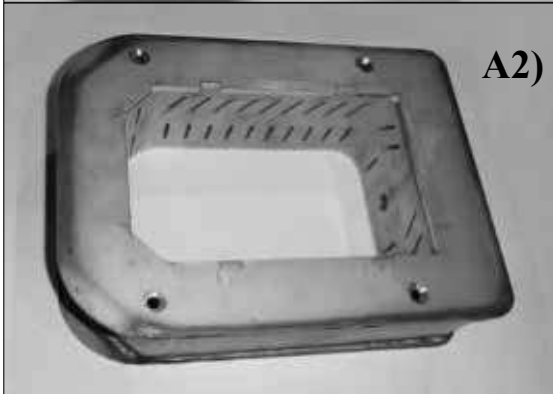

A2)



B)

Code: H0149 A) combustion chamber - upper part	<i>Price:</i>
	<i>Weight: 4,24 kg</i>
Code: H0149 A) combustion chamber - upper part - ATMOS	<i>Price:</i>
	<i>Weight: 4,86 kg</i>
Code: H0150 B) combustion chamber - lower part	<i>Price:</i>
	<i>Weight: 3,80 kg</i>

Spare internal pushing auger - bottom

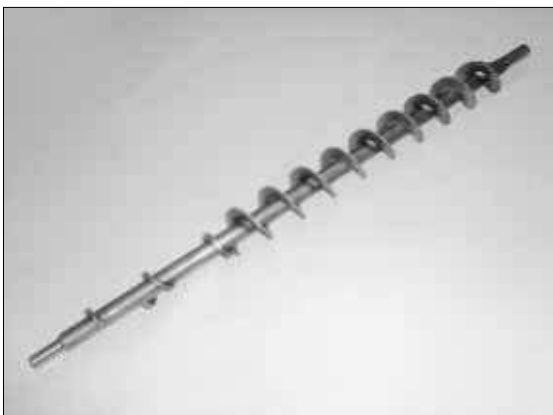

Code: H0200 spare internal pushing auger	<i>Price:</i>
	<i>Weight: 1,84 kg</i>

Ignition spiral



Code: H0128 spare ignition spiral	<i>Price:</i>
	<i>Weight: 0,20 kg</i>

Primary air blower fan – without crosshatch



Code: H0126 primary air blower fan – without crosshatch	<i>Price:</i>
	<i>Weight: 1,50 kg</i>

Secondary air blower fan – with crosshatch



Code: H0125 secondary air blower fan – with crosshatch	<i>Price:</i>
	<i>Weight: 1,38 kg</i>

Optical sensor for measuring of pellet level

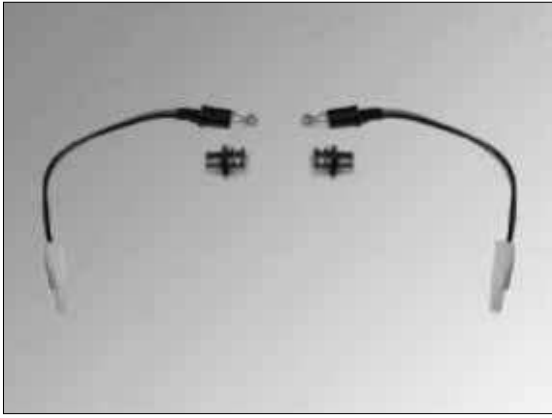

Code: H0129 optical sensor for pellet level – 2 pcs	<i>Price:</i> <i>Weight:</i> 0,02 kg
---	---

Data cable for sensors



Code: H0144 data cable for sensors	<i>Price:</i> <i>Weight:</i> 0,10 kg
---	---

Waste gas temperature sensor

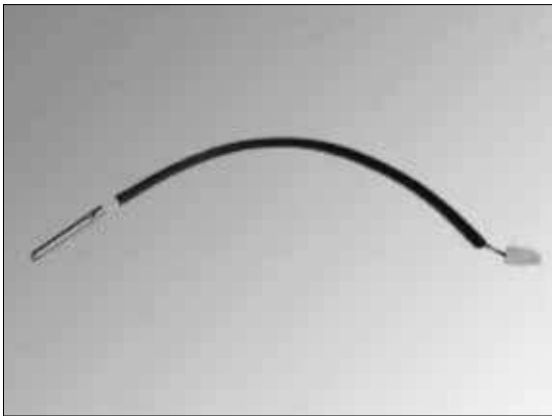

Code: H0141 waste gas temperature sensor	<i>Price:</i> <i>Weight:</i> 0,08 kg
--	---

Adapter from connector to connector Faston

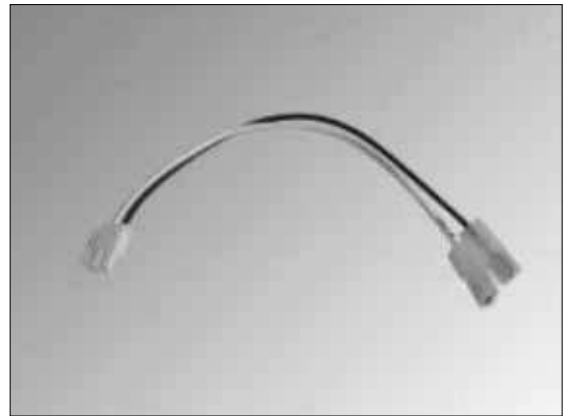

Code: H0145 adapter from connector to connector Faston	<i>Price:</i> <i>Weight:</i> 0,03 kg
--	---

Supply cable from the boiler to the burner



Code: H0143 incoming cable into burner	<i>Price:</i> <i>Weight:</i> 0,45 kg
---	---

Jumper for extra safety thermostat



Code: H0146 jumper for extra safety thermostat (brown/white wire)	<i>Price:</i> <i>Weight:</i> 0,07 kg
---	---

Extension cable for for waste gas sensor

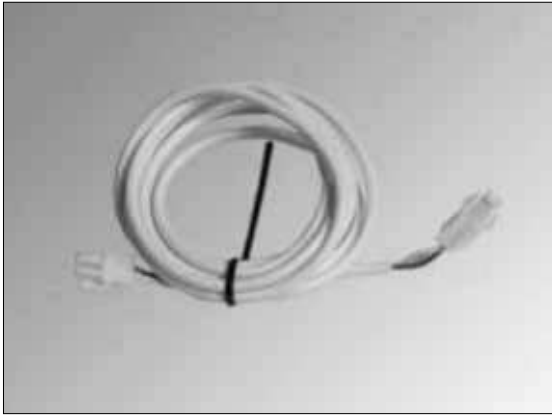

Code: H0147 extension cable for waste gas sensor with lenght – 1,8 m	<i>Price:</i>
	<i>Weight: 0,25 kg</i>
Code: H0148 extension cable for waste gas sensor with lenght – 1 m	<i>Price:</i>
	<i>Weight: 0,20 kg</i>

Cog wheels



Code: H0133 cog wheel with 12 cogs – inner auger – tourniquet	<i>Price:</i>
	<i>Weight: 0,30 kg</i>
Code: H0134 cog wheel with 17 cogs – engine + gearbox	<i>Price:</i>
	<i>Weight: 0,35 kg</i>
Code: H0135 cog wheel with 18 cogs – main auger to the combustion chamber	<i>Price:</i>
	<i>Weight: 0,35 kg</i>
Code: H0136 cog wheel with 24 cogs – upper auger of the filling	<i>Price:</i>
	<i>Weight: 0,40 kg</i>

Slide bearing



Code: H0138 A set of sliding bearings (6 pcs) – 3 types	<i>Price:</i>
	<i>Weight: 0,09 kg</i>

Inner blades of the turnstile

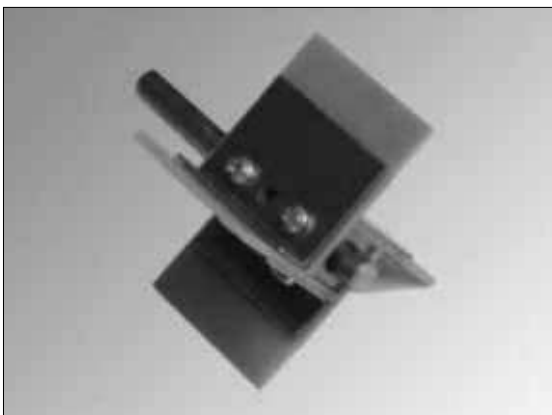

Code: H0132 inner blades of the tourniquet – shaft with blades	<i>Price:</i>
	<i>Weight: 0,18 kg</i>

Chain with clip

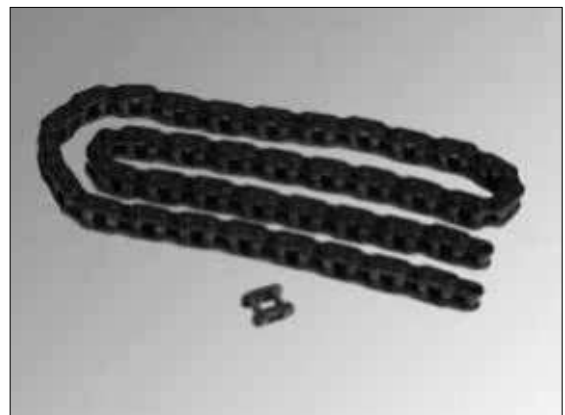

Code: H0137 chain with clip	<i>Price:</i>
	<i>Weight: 0,32 kg</i>

Gearbox for pellet conveyor type DA



Code: H0186 gearbox for pellet conveyor DA length 1,7m and for 2,5m. Diameter of the shaft - 10 mm
 Attention – if changing the red one by the grey one you have to change the running direction in the motor of the gearbox after the electric diagram of the engine.

<i>Price:</i>
<i>Weight:</i> 3,50 kg

Incoming module AC05

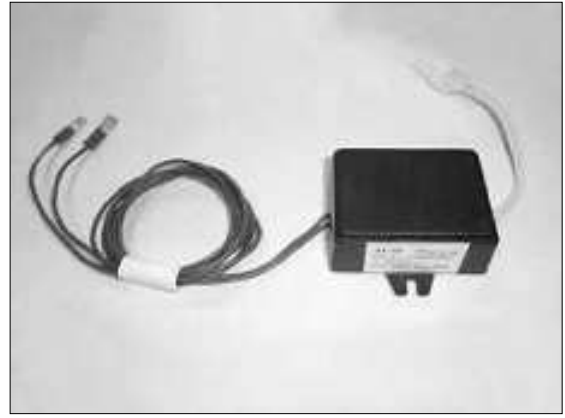

Code: S0076 conversion module AC05 for controlling the burner by the boiler's regulating thermostat

<i>Price:</i>
<i>Weight:</i> 0,07 kg

Spare gear box for conveyor DA – 40W



Code: H0159 spare gearbox for pellets conveyor DA50 1,7m a 2,5m with input 40W. Diameter of the shaft - 12 mm.

<i>Price:</i>
<i>Weight:</i> 4,50 kg

Flange gasket

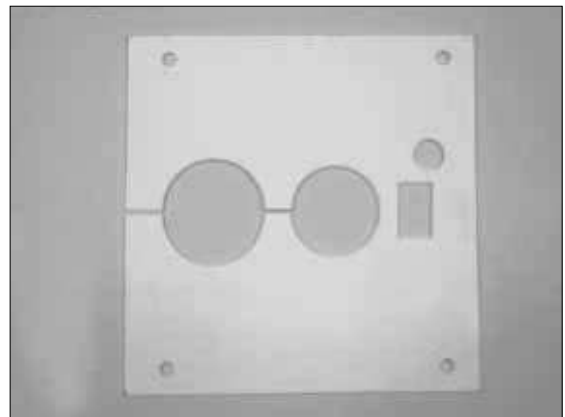

Code: S0130 Flange gasket for burner A50

<i>Price:</i>
<i>Weight:</i> 0,10 kg

Module DPA70 for prolonging of running of the suction fan



Code: H0184 spare module DPA70 for prolonging of running of the suction fan - 5 pin	<i>Price:</i>
	<i>Weight:</i> 0,40 kg
Code: H0185 spare module DPA70 for prolonging of running of the suction fan - 4 pin	<i>Price:</i>
	<i>Weight:</i> 0,40 kg

13. Automatic ash removal for DxxP boilers

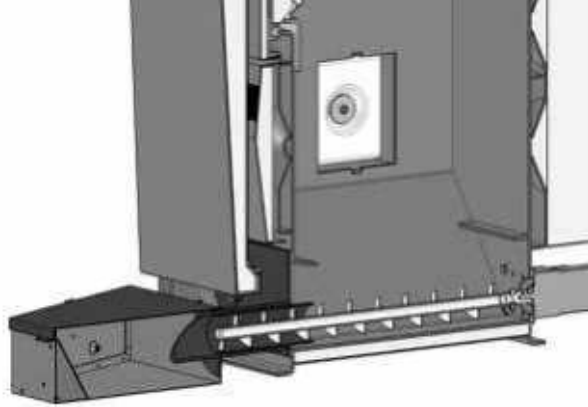

Ash removal device

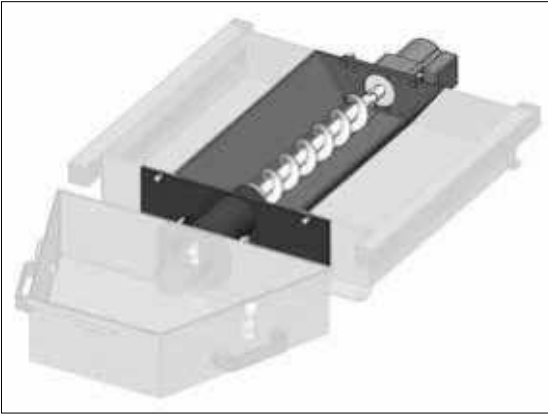

Code: S0577 Ash removal device – without additional ash pan for boilers D14P, D21P, D14P Compact, D21P Compact, P14, P21	<i>Price:</i> <i>Weight:</i> 11,06 kg
Code: S0578 Ash removal device – without additional ash pan for boilers D25P, D25P Compact, P25	<i>Price:</i> <i>Weight:</i> 11,62 kg
Code: S1474 Ash removal device – without additional ash pan – flange diameter 89 mm for boilers P14 Compact, P21 Compact	<i>Price:</i> <i>Weight:</i> 11,06 kg
Code: S1475 Ash removal device – without additional ash pan – flange diameter 89 mm for boilers P25 Compact	<i>Price:</i> <i>Weight:</i> 11,62 kg
Code: S0535 Ash removal device – without additional ash pan for boilers D15P, D20P, P15, P20	<i>Price:</i> <i>Weight:</i> 13,34 kg
Code: S0536 Ash removal device – without additional ash pan for boilers D30P, D40P, P30, P40	<i>Price:</i> <i>Weight:</i> 17,54 kg
Code: S0537 Ash removal device – without additional ash pan for boilers D50P (D45P), P50	<i>Price:</i> <i>Weight:</i> 17,88 kg
Code: S1080 Ash removal device – without additional ash pan for boilers D80P, P80	<i>Price:</i> <i>Weight:</i> 17,50 kg
Code: S1098 Ash removal device – without flange – without additional ash pan for boiler D85P, P85	<i>Price:</i> <i>Weight:</i> 21,50 kg

Additional ash pans



Additional ash pans for boilers D14P, D21P, D25P, D31P, D15P, D20P, D30P, D40P, D50P (D45P), D14P Compact, D21P Compact, D25P Compact, P14, P21, P25, P31, P15, P20, P30, P40, P50 P14 Compact, P21 Compact, P25 Compact,	
Code: S1229 additional ash pan with volume 18 l - tilted	<i>Price:</i> <i>Weight:</i> 5,50 kg
Code: S1458 additional ash pan with volume 27 l - tilted/higher – flange diameter 89 mm for boilers P14 Compact, P21 Compact, P25 Compact	<i>Price:</i> <i>Weight:</i> 8,30 kg
Code: S0542 additional ash pan with volume 28 l (450x250x250)	<i>Price:</i> <i>Weight:</i> 7,70 kg
Code: S0544 additional ash pan with volume 68 l (450x300x500)	<i>Price:</i> <i>Weight:</i> 11,90 kg
Code: S0546 additional ash pan with volume 135 l (600x450x500)	<i>Price:</i> <i>Weight:</i> 18,46 kg
Additional ash pans for boilers D80P, P80	
Code: S1068 additional ash pan with volume 68 l (450x300x500) - Ø auger 80 mm	<i>Price:</i> <i>Weight:</i> 11,90 kg
Code: S1069 additional ash pan with volume 135 l (600x450x500) - Ø auger 80 mm	<i>Price:</i> <i>Weight:</i> 18,46 kg
Additional ash pans for boiler D85P, P85	
Code: S1409 additional ash pan with volume 160 l (600x770x530) - flange diameter 131 mm - auger diameter 80 mm	<i>Price:</i> <i>Weight:</i> 28,50 kg

Parts for fitting automatic ash removal

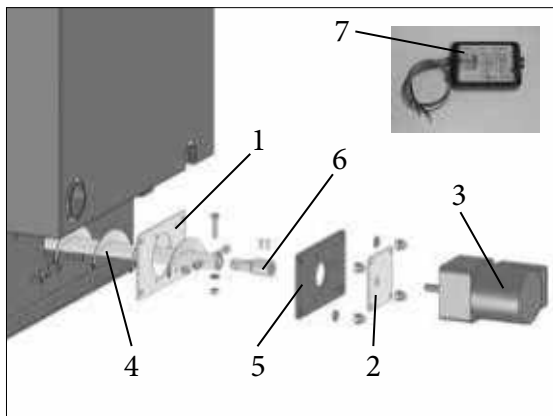

Code: S0125 Nr. 1 sealing of the gearbox flange	Price:
	Weight: 0,01 kg
Code: S0126 Nr. 2 gearbox sealing	Price:
	Weight: 0,01 kg
Code: H0107 Nr. 3 gearbox 25W	Price:
	Weight: 2,72 kg
Code: H0115 Nr. 3 gearbox 15W	Price:
	Weight: 2,50 kg
Code: S0538 Nr. 4 auger shaft – lenght 530 mm for boilers D15P, D20P, P15, P20	Price:
	Weight: 1,36 kg
Code: S0539 Nr. 4 auger shaft – lenght 730 mm for boilers D25P, D25P Compact, P25, P25 Compact, D30P, D40P, P30, P40	Price:
	Weight: 1,94 kg
Code: S0540 Nr. 4 auger shaft – lenght 930 mm for boilers D50P (D45P), P50,	Price:
	Weight: 2,36 kg
Code: S0541 Nr. 4 auger shaft – lenght 630 mm for boilers D14P, D21P, P14, P21, D14P Compact, D21P Compact, P14 Compact, P21 Compact	Price:
	Weight: 1,85 kg
Code: S0545 Nr. 4 auger shaft – lenght 1125 mm for boiler D80P, P80	Price:
	Weight: 2,85 kg
Code: S1442 Nr. 5 flange of ash removal gearbox for boilers D14P - D50P, P14 - P50	Price:
	Weight: 0,40 kg
Code: S1611 Nr. 5. flange of ash removal gearbox for boiler D80P, P80	Price:
	Weight: 0,50 kg
Code: S1612 Nr. 6 carrier pin of the gearbox and auger shaft for boilers D14P - D80P, P14 - P80	Price:
	Weight: 0,15 kg
Code: S0077 Nr. 7 electronic module AD01 for automatic ash removal timing	Price:
	Weight: 0,18 kg

Parts for fitting automatic ash removal D85P, P85

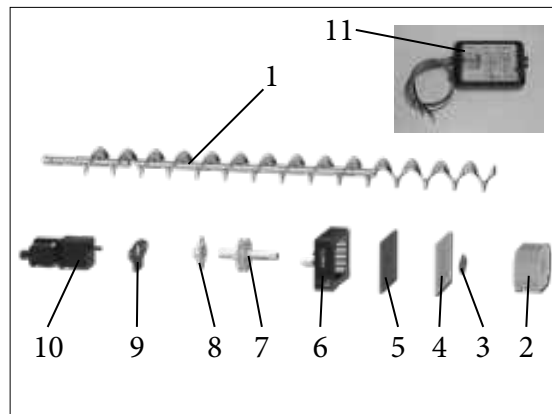

Code: H0002 Nr. 1 auger shaft – lenght 1275 mm for boiler D85P, P85	Price:
	Weight: 3,80 kg
Code: S1410 Nr. 2 insulation of the gearbox extension	Price:
	Weight: 0,60 kg
Code: S1599 Nr. 3 seal holder	Price:
	Weight: 0,10 kg
Code: S1411 Nr. 4 gearbox flange gasket	Price:
	Weight: 0,11 kg
Code: S1600 Nr. 5 ash removal gearbox flange	Price:
	Weight: 1,07 kg
Code: S1606 Nr. 6 ash removal drive cooling hood with locking pins	Price:
	Weight: 1,80 kg
Code: S1607 Nr. 7 carrier pin of the drive (gearbox) of the ash removal	Price:
	Weight: 0,60 kg
Code: H0198 Nr. 8 complete set - bearing + housing - 2 pcs	Price:
	Weight: 0,22 kg
Code: S1608 Nr. 9 drive (gearbox) ash removal holder	Price:
	Weight: 0,30 kg
Code: H0115 Nr. 10 engine with gearbox - 15 W	Price:
	Weight: 2,50 kg
Code: S0077 Nr. 11 electronic module AD01 for automatic ash removal timing	Price:
	Weight: 0,18 kg

Parts for fitting the ash pan flange

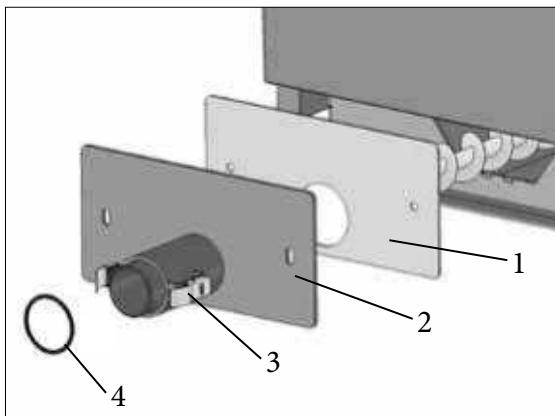

Code: S0127 Nr. 1 flange seal for ash pan mounting	<i>Price:</i>
	<i>Weight:</i> 0,03 kg
Code: S1437 Nr. 1 flange seal for ash pan mounting - Pxx Compact	<i>Price:</i>
	<i>Weight:</i> 0,03 kg
Code: S1412 Nr. 1 flange seal for ash pan mounting - D85P, P85	<i>Price:</i>
	<i>Weight:</i> 0,29 kg
Code: S1609 Nr. 2 flange seal for ash pan mounting - D85P, P85	<i>Price:</i>
	<i>Weight:</i> 7,90 kg
Code: V0129 Nr. 3 spare clip for ash pan mounting	<i>Price:</i>
	<i>Weight:</i> 0,03 kg
Code: S0549 Nr. 4 O – ring –ash pan flange seal – Ø 68x3,5 mm	<i>Price:</i>
	<i>Weight:</i> 0,01 kg
Code: S1436 Nr. 4 O – ring – ash pan flange seal – Ø 87x3,5 mm - pro Pxx Compact	<i>Price:</i>
	<i>Weight:</i> 0,01 kg
Code: S1531 Nr. 4 O – ring – ash pan flange seal – Ø 85x3,5 mm- D80P, P80	<i>Price:</i>
	<i>Weight:</i> 0,01 kg
Code: S1416 Nr. 4 O – ring – ash pan flange seal – Ø 130x5 mm- D85P, P85	<i>Price:</i>
	<i>Weight:</i> 0,01 kg
Code: S0280 spare sealing tape of the lid of the additional ash pan (28 and 68 l)	<i>Price:</i>
	<i>Weight:</i> 0,06 kg
Code: S0288 spare sealing tape of the lid of the additional ash pan (135 l)	<i>Price:</i>
	<i>Weight:</i> 0,03 kg
Code: S0411 decorative nut for sealing the opening after removing the grid rod for boilers D15P, D20P, D30P, D40P, D50P (D45P), P15, P20, P30, P40, P50	<i>Price:</i>
	<i>Weight:</i> 0,06 kg

14. Pneumatic pellet feeding APS 150, 250 (S) (SPX(2)) (KSP3) 500



Pneumatic pellet feeding ATMOS APS



Code: H0550 pneumatic pellet feeding ATMOS APS 250 - red	<i>Price:</i>
	<i>Weight:</i> 81,00 kg
Code: H0551 pneumatic pellet feeding ATMOS APS 250 - blue	<i>Price:</i>
	<i>Weight:</i> 81,00 kg
Code: H0313 pneumatic pellet feeding ATMOS APS 250 S - separate (set without tank) - red	<i>Price:</i>
	<i>Weight:</i> 45,00 kg
Code: H0314 pneumatic pellet feeding ATMOS APS 250 S - separate (set without tank) - blue	<i>Price:</i>
	<i>Weight:</i> 45,00 kg
Code: H0563 pneumatic pellet feeding ATMOS APS 150 SPX - separate (set without tank) - for D10PX - red/dark grey	<i>Price:</i>
	<i>Weight:</i> 30,00 kg
Code: H0317 pneumatic pellet feeding ATMOS APS 250 SPX - separate (set without tank) - for D15PX, D20PX - dark grey/red	<i>Price:</i>
	<i>Weight:</i> 57,00 kg
Code: H0319 pneumatic pellet feeding ATMOS APS 250 SPX2 - separate (set without tank) - for D25PX - dark grey/red	<i>Price:</i>
	<i>Weight:</i> 47,00 kg
Code: H0323 pneumatic pellet feeding ATMOS APS 250 SPK3 - separate (set without tank) - red - for AZPD 400 / AZPU 400	<i>Price:</i>
	<i>Weight:</i> 46,00 kg
Code: H0324 pneumatic pellet feeding ATMOS APS 250 SPK3 - separate (set without tank) - blue - for AZPD 400 / AZPU 400	<i>Price:</i>
	<i>Weight:</i> 46,00 kg
Code: H0315 pneumatic pellet feeding ATMOS APS 500 - for two boilers (conveyors and burners) - red	<i>Price:</i>
	<i>Weight:</i> 110,0 kg
Code: H0316 pneumatic pellet feeding ATMOS APS 500 - for two boilers (conveyors and burners) - blue	<i>Price:</i>
	<i>Weight:</i> 110,0 kg
Code: H0575 Special set of pneumatic pellet feeding ATMOS APS 250 for boilers D85P, P85 - set contains pneumatic pellet feeding, 250 l container on wheels, shaft conveyor DRA50 with modified length and special gearbox (12 rpm). Set can be used for all boilers equipped with pellet burner ATMOS A45 and A85.	<i>Price:</i>
	<i>Weight:</i> 123,5 kg

Suction fan motor (turbine) - separate



Code: S1136 suction fan motor (turbine) - separate	<i>Price:</i>
	<i>Weight:</i> 3,60 kg

Antistatic tube with 50 mm diameter

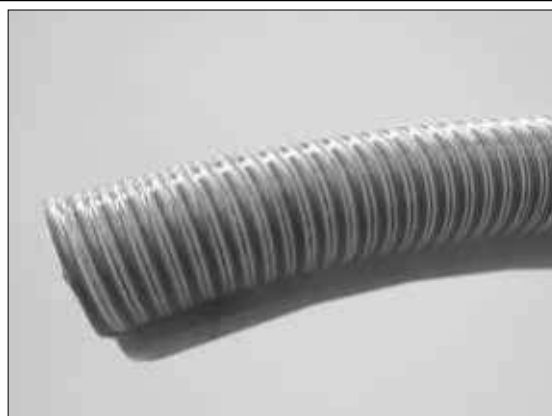

Code: H0112 special pipe for connecting suction ventilator with external silo. The pipe is supplied in specific lengths 12,5 m, 25 m. The price is for 1 m.	<i>Price:</i>
	<i>Weight:</i> 0,75 kg
Code: H0571 tightening clamp for pneumatic transport hose	<i>Price:</i>
	<i>Weight:</i> 0,02 kg

Control unit AC21

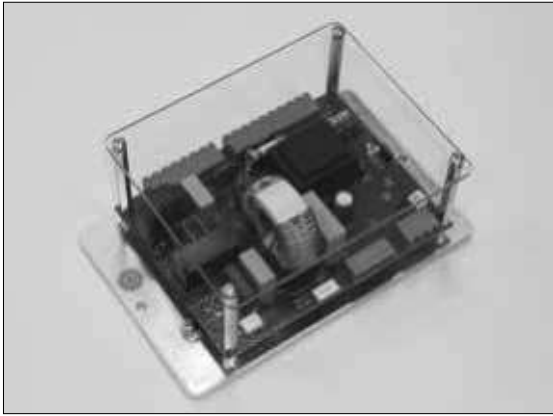

Code: P0460 control unit AC21 for pneumatic pellet feeding APS

Price:
Weight: 0,46 kg

Self-sticking label for control panel

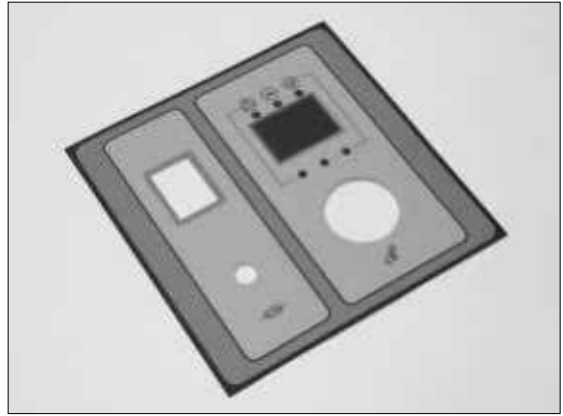

Code: S1188 self-sticking label for pneumatic pellet feeding APS

Price:
Weight: 0,01 kg

Electronic controller AC19



Code: P0449 AC19 controller is designed to control pneumatic pellet feeding APS 250/500

Price:
Weight: 0,54 kg

Level sensor



Code: S1135 level sensor for pneumatic pellet feeding APS

Price:
Weight: 1,50 kg

Code: S1133 propeller level sensor for pneumatic pellet feeding

Price:
Weight: 0,26 kg

Code: S1288 propeller level sensor for APS 250 SPX - shorter

Price:
Weight: 0,14 kg

Code: S1610 propeller level sensor for APS 250 for D85P, P85 - 404 mm

Price:
Weight: 0,14 kg

Electric wiring



Code: S0720 spare electric wiring for pneumatic pellet feeding APS

Price:
Weight: 0,88 kg

Filter



Code: S1115 spare filter for pneumatic pellet feeding APS

Price:
Weight: 0,01 kg

Handel



Code: S1079 B) handle for pneumatic feeding system APS

Price:
Weight: 0,04 kg

Grommet



Code: S1191 spare grommet

Price:
Weight: 0,01 kg

Connector to control night mode - red

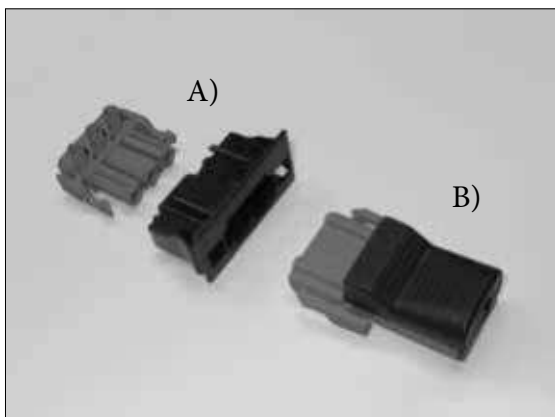

Code: S1102 A) female connector with bushing into the boiler side hood for control of night mode - red - 3 pin

Price:
Weight: 0,01 kg

Code: S1103 B) male connector for cable - 3 pin

Price:
Weight: 0,01 kg

Connector for electrical power

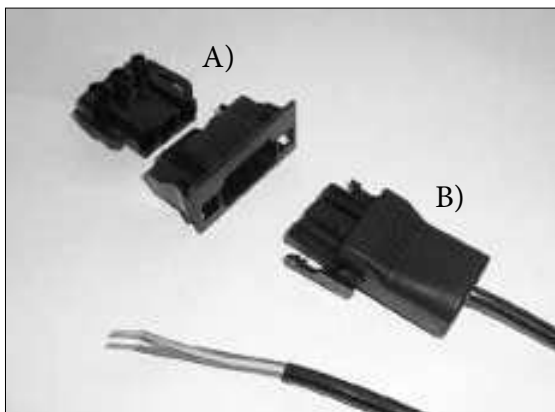

Code: S0641 A) male connector with bushing

Price:
Weight: 0,01 kg

Code: S0640 B) female connector for cable

Price:
Weight: 0,01 kg

Code: S0715 incoming cable 2,5 m with connector type B) (S0640)

Price:
Weight: 0,15 kg

Hood for pneumatic pellet feeding APS



Code: H0561 spare fairing for pneumatic transport - red

Price:
Weight: 10,50 kg

Code: H0562 spare fairing for pneumatic transport - blue

Price:
Weight: 10,50 kg

Code: H0565 spare fairing for pneumatic transport - dark grey/red
APS 250 SPX (D15PX, D20PX, PX15, PX20)
APS 250 SPX2 (D25PX, PX25)

Price:
Weight: 10,50 kg

Code: H0564 spare fairing for pneumatic transport - red/dark grey
APS 150 SPX (D10PX, PX10)

Price:
Weight: 12,00 kg

Buffer tank for APS 250 / APS 500

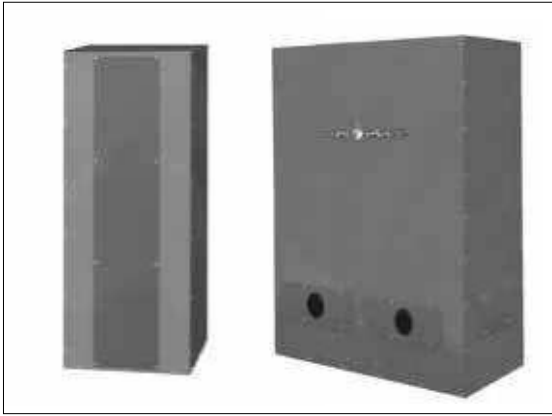

Code: H0557 spare buffer tank for APS 250 - red	<i>Price:</i>
	<i>Weight: 30,00 kg</i>
Code: H0558 spare buffer tank for APS 250 - blue	<i>Price:</i>
	<i>Weight: 30,00 kg</i>
Code: H0559 spare buffer tank for APS 500 - red	<i>Price:</i>
	<i>Weight: 45,00 kg</i>
Code: H0560 spare buffer tank for APS 500 - blue	<i>Price:</i>
	<i>Weight: 45,00 kg</i>
Code: H0577 spare buffer tank for APS 250 for boilers D85P, P85 - on the wheels	<i>Price:</i>
	<i>Weight: 59,30 kg</i>

Frames for APS

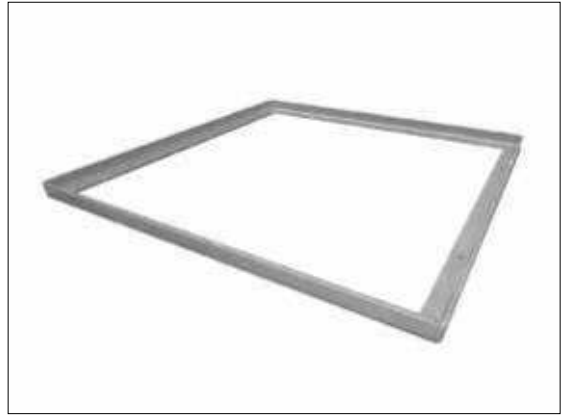

Code: S1189 frame for APS 250 S - for different pellet tanks	<i>Price:</i>
	<i>Weight: 1,68 kg</i>
Code: S1373 frame for APS 150 SPX - for D10PX, PX10	<i>Price:</i>
	<i>Weight: 2,01 kg</i>
Code: S1342 frame for APS 250 SPX - for D15-20PX, PX15-20	<i>Price:</i>
	<i>Weight: 2,05 kg</i>
Code: S1374 frame for APS 250 SPX2 - for D25PX, PX25	<i>Price:</i>
	<i>Weight: 3,93 kg</i>
Code: S1375 frame for APS 250 SPK3 - for AZPD 400 / AZPU 400	<i>Price:</i>
	<i>Weight: 2,50 kg</i>

Divided lid for pellet tanks - for APS 250 S

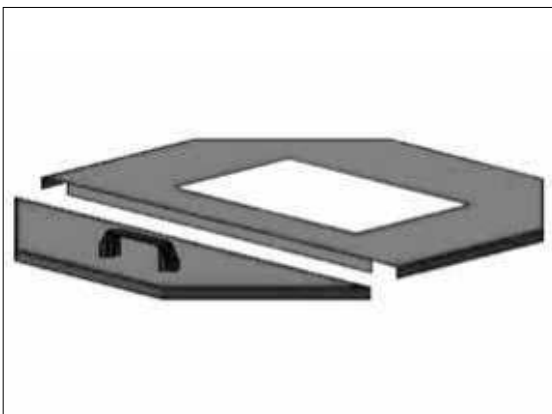

Code: H0552 lid for tank 1000 l - red for pneumatic feeding APS 250 S	<i>Price:</i>
	<i>Weight: 14,76 kg</i>
Code: H0553 lid for tank 500 l - red for pneumatic feeding APS 250 S	<i>Price:</i>
	<i>Weight: 6,96 kg</i>
Code: H0554 lid for tank 1000 l - blue for pneumatic feeding APS 250 S	<i>Price:</i>
	<i>Weight: 14,76 kg</i>
Code: H0555 lid for tank 500 l - blue for pneumatic feeding APS 250 S	<i>Price:</i>
	<i>Weight: 6,96 kg</i>

Pneumatic probe

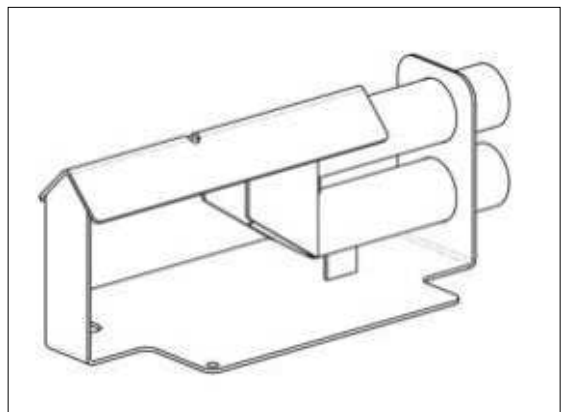

Code: H0511 it is designed for the multipoint suction of pellets from the container with a flat (slanting) bottom	<i>Price:</i>
	<i>Weight: 4,60 kg</i>

Switcher for pneumatic feeder

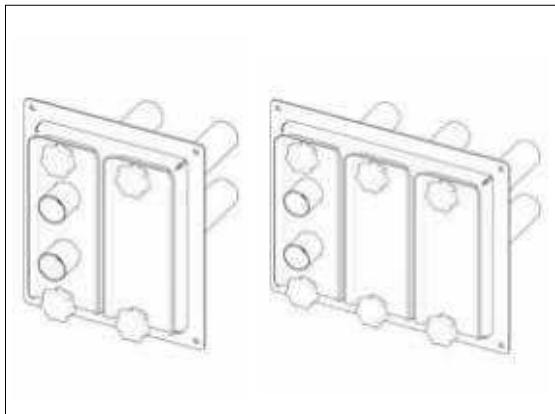

it is designed for the pneumatic pellet feeder with use of two pneumatic probes (H0511) in silo with flat (slanting) floor. Used to swap (change) sucking point in the silo.

If a large number of probes is possible to sort the changers side by side.

Code: H0542 - 2 circuits	Price:
	Weight: 13,90 kg
Code: H0543 - 3 circuits	Price:
	Weight: 19,14 kg

Mole - movable pellet suction system



Code: H0293 suction system for wooden pellets is designed for pellet transport from large silo in to the boiler-room space with use of ATMOS pneumatic pellet feeding

Price:
Weight: 13,90 kg

Sealing of the pneumatic transport and the frame



Code: S1405 spare sealing of the pneumatic transport and the frame APS - self-adhesive - divided - 4 pcs (4x 0,5 m)

Price:
Weight: 0,01 kg

Elbows (turns) and couplings for pneumatic pellet transport hoses



Code: H0567 elbow 30°	Price:
	Weight: 0,64 kg
Code: H0568 elbow 45°	Price:
	Weight: 0,78 kg
Code: H0569 elbow 90°	Price:
	Weight: 1,20 kg
Code: H0570 hose coupling 100 mm - Ø 50 mm	Price:
	Weight: 0,18 kg
Code: H0571 tightening hose clamp for 50 - 70 mm diameter	Price:
	Weight: 0,02 kg

Rubber flap sealing for APS



Code: S1451 spare Rubber flap sealing for APS - 335 mm

Price:
Weight: 0,06 kg

The wheel of APS 250 tank for boilers D85P, P85



Code: S1407 spare wheel of APS 250 tank
for D85P, P85 - 70 mm diameter

Price:

Weight: 0,32 kg

15. LFO and Natural gas burners

LFO or natural gas burner



Code: H0018 LFO burner — Riello 40G3RK	<i>Price:</i> <i>Weight:</i> 11,34 kg
Code: H0017 natural gas burner — Riello 40GS+MDB055	<i>Price:</i> <i>Weight:</i> 12,62 kg
Code: H0019 connecting cable for LFO burner — not delivered with burner	<i>Price:</i> <i>Weight:</i> 0,06 kg

Spare parts + accessories:

Title	Code	Price	Weight
Spare parts for natural gas burner Riello 40G S 3 code 3755116 – 3755117 type 551 T1			
Automatic unit 525 SE/5	H0073		0,48 kg
Air manostat	H0074		0,24 kg
Ignition coil	H0075		0,05 kg
Ionization electrode	H0076		0,03 kg
Electric motor (same for G+C38RK)	H0077		2,70 kg
Spare parts for oil burner Riello 40G 3 RK code 3743412 type 434 T1			
Automatic unit 531 SE	H0078		0,44 kg
Light resistor	H0079		0,02 kg
Capacitor 4 µF	H0080		0,08 kg
Tenon	H0081		0,01 kg
Pump	H0082		1,09 kg
Pump sealing	H0083		0,03 kg
Pump filter	H0084		0,01 kg
Valve	H0085		0,03 kg
Coil	H0086		0,06 kg
Electrodes	H0087		0,18 kg
Heating resistance	H0088		0,03 kg
Accessories			
Oil filter / automatic air-bleeding valve – TOC80	H0089		0,01 kg
Connector 8	H0090		0,09 kg
Connector 10	H0091		0,02 kg
Nozzle Delavan - 40/60/W – (15kW)	H0092		0,02 kg
Nozzle Delavan – 0,50/60/W – (20kW)	H0093		0,02 kg
Nozzle Delavan – 0,60/60/W – (25kW)	H0094		0,03 kg
Nozzle Delavan – 0,65/60/W – (30kW)	H0095		0,03 kg
Nozzle Delavan – 0,75/60/B – (35kW)	H0096		0,03 kg
ProTek valve	H0097		0,07 kg

16. Textile pellet silos ATZ



Textile silo ATZ - complete



Code: H0505 textile silo ATZ 5 with accessories - 3,9 - 4,6 m ³	<i>Price:</i>
	<i>Weight:</i> 239,00 kg
Code: H0506 textile silo ATZ 6 with accessories - 4,8 - 5,6 m ³	<i>Price:</i>
	<i>Weight:</i> 242,00 kg
Code: H0507 textile silo ATZ 7 with accessories - 5,8 - 6,8 m ³	<i>Price:</i>
	<i>Weight:</i> 250,00 kg

Textile sack for ATZ - separate



Code: S0758 spare sack for textile silo ATZ 5	<i>Price:</i>
	<i>Weight:</i> 9,70 kg
Code: S0759 spare sack for textile silo ATZ 6	<i>Price:</i>
	<i>Weight:</i> 10,80 kg
Code: S0760 spare sack for textile silo ATZ 7	<i>Price:</i>
	<i>Weight:</i> 12,00 kg

Multi-purpose container for textile silos ATZ

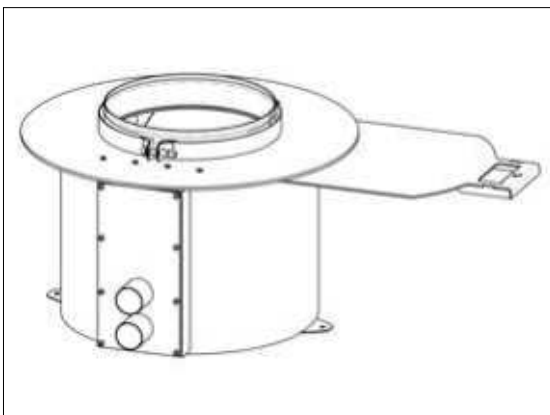

Code: H0510 it is equipped with a pneumatic suction probe and replaceable adapter allowing direct scooping of pellets by the auger conveyor	<i>Price:</i>
	<i>Weight:</i> 26,60 kg
Code: S1029 gasket for flange of changeable parts (probes) 152x240x4	<i>Price:</i>
	<i>Weight:</i> 0,11 kg

Internal equipment for multi-purpose container

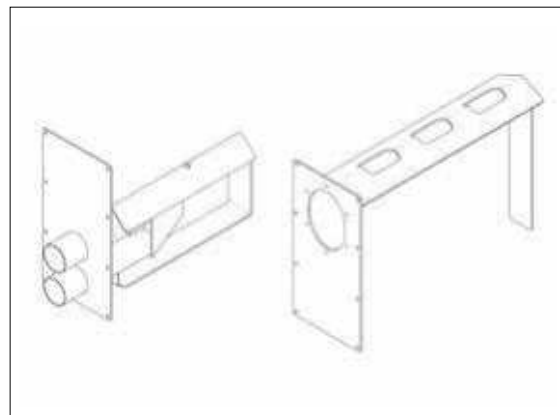

Code: H0515 spare pneumatic suction probe	<i>Price:</i>
	<i>Weight:</i> 3,10 kg
Code: H0516 spare reduction allowing direct scooping of pellets by the conveyor	<i>Price:</i>
	<i>Weight:</i> 2,20 kg

**Construction for ATZ without filling nozzles
(including connecting materials)**



Code: V0005 spare structure for textile silo ATZ 5 - 4,4 - 5,5 m ³	<i>Price:</i>
	<i>Weight:</i> 149,80 kg
Code: V0006 spare structure for textile silo ATZ 6 - 5,3 - 6,5 m ³	<i>Price:</i>
	<i>Weight:</i> 154,10 kg
Code: V0007 spare structure for textile silo ATZ 7 - 6,3 - 7,9 m ³	<i>Price:</i>
	<i>Weight:</i> 158,40 kg

Textile silo leg



Code: S0628 spare leg for textile silos ATZ	<i>Price:</i>
	<i>Weight:</i> 11,50 kg

Upper beam for textile silo

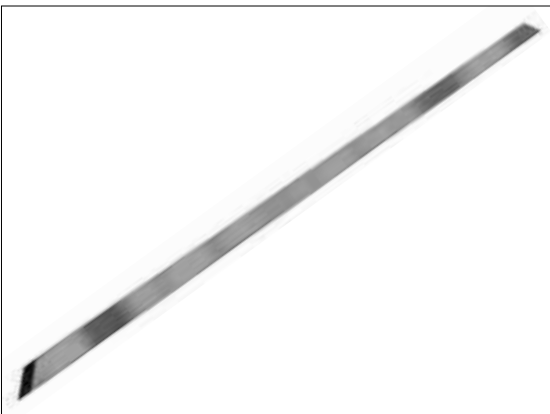

Code: S0792 spare upper beam - lenght 1905 mm	<i>Price:</i>
	<i>Weight:</i> 13,90 kg
Code: S0749 spare upper beam - lenght 2305 mm	<i>Price:</i>
	<i>Weight:</i> 15,90 kg

Filler neck cap for textile silos ATZ



Code: H0517 complete filler neck for textile silos ATZ including STORZ A110	<i>Price:</i>
	<i>Weight:</i> 6,50 kg
Code: S1196 filler neck collar (holder) - separate	<i>Price:</i>
	<i>Weight:</i> 3,90 kg
Code: S0762 filler neck STORZ A110	<i>Price:</i>
	<i>Weight:</i> 1,20 kg
Code: S0764 filler cap - separate lid STORZ A110	<i>Price:</i>
	<i>Weight:</i> 1,20 kg
Code: H0306 spare fixing band	<i>Price:</i>
	<i>Weight:</i> 0,06 kg

Lower beam for textile silo



Code: S0629 spare lower beam - lenght 1810 mm	<i>Price:</i>
	<i>Weight:</i> 9,80 kg
Code: S0630 spare lower beam - lenght 2210 mm	<i>Price:</i>
	<i>Weight:</i> 12,10 kg

Textile sack upper hook



Code: H0518 spare upper hook for textile silo	<i>Price:</i>
	<i>Weight:</i> 1,00 kg

17. External combustion air supply for ATMOS A25 burner



Flange of external air intake for A25



Code: S1386 Flange of external air intake for A25

Price:
Weight: 1,15 kg

Aluminum hose - Ø 100 mm



Code: S1388 Aluminum hose with inner diameter 100 mm and length 5 m (for hole in the wall with diameter 110 mm)

Price:
Weight: 0,60 kg

Sealing under the Flange of external air intake



Code: S1308 Sealing under the Flange of external air intake

Price:
Weight: 0,01 kg

Flexible hose - Ø 100 mm

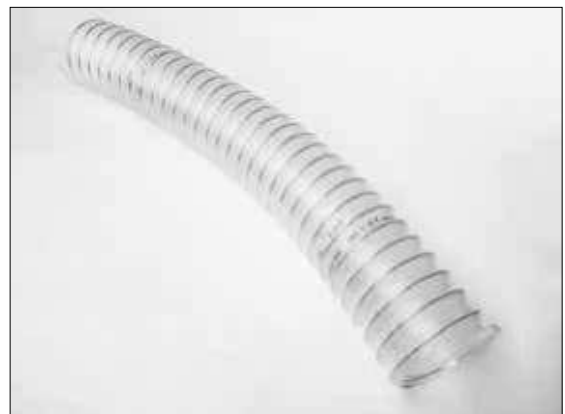

Code: S1389 Flexible hose with diameter 100 mm and length 70 cm (for DxxPX, PXxx)

Price:
Weight: 0,04 kg

Tightening clamp



Code: H0572 tightening clamp 90 - 110 mm - for attaching the hose to the hose holder with socket - stainless steel	<i>Price:</i> <i>Weight:</i> 0,02 kg
---	---

Exterior wall vent cover



Code: S1387 Exterior wall vent cover (circle)	<i>Price</i> <i>Weight:</i> 0,04 kg
---	--

Hose holder with socket



Code: H0349 hose holder with socket - flexible and rigid hose coupling (for DxxPX, PXxx)	<i>Price</i> <i>Weight:</i> 0,74 kg
---	--

Hose holder



Code: H0348 hose holder - for attaching the hose on the boiler or wall	<i>Price</i> <i>Weight:</i> 0,19 kg
--	--

18. Connection of ATMOS Fxx, Compact boilers

F1 Laddomat

P0601







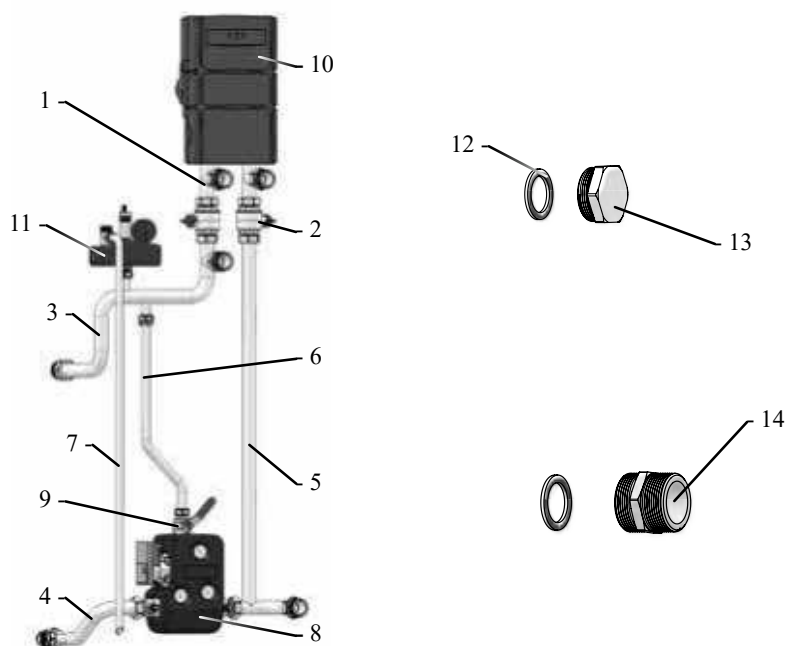

for boilers: DC18S, DC22S, DC22SX, DC25S, DC30SX, KC16S, KC25S, C15S, C18S, AC16S, AC25S





F5 Laddomat

P0605



Spare parts for Connection F1 Laddomat, F5 Laddomat:

Pos.	Name		Code	Price	Weight
1	T part Ø 35		S1519		0,60 kg
2	ball valve WESA - 6/4" - outer thread		P0532		1,02 kg
3	branch Ø 35 - outlet pipe from the boiler		S1518		1,70 kg
4	pipe Ø 35 - return to boiler for assembly with Laddomat X22 (with branch for expansion tank)		S1520		0,80 kg
5	connection pipe Ø 35 - return from system and tank for assembly with Laddomat X22		S1523		2,00 kg
6	connection pipe Ø 22 (shortcut) for assembly with Laddomat X22		S1514		0,60 kg
7	safety valve pipe Ø 18 for assembly with Laddomat X22		S1510		0,50 kg
8	Laddomat X22		P0247		5,60 kg
9	fitting / ball valve 2"/1" - outer thread		P0254		0,60 kg
Another spare parts for Laddomat can be found on page 63.					

10	Circulation unit ATMOS/ESBE GRA 211 mixing (without servo actuator, only with knob) - spacing 125 mm - 6/4" / 1" - (1x40 kW) - with connector and cable for a pump		P0538		6,40 kg
	spare pump		P0521		1,88 kg
	a set (heart) of a three-way valve with accessories - renovation kit		P0528		0,04 kg
	three-way valve knob for GRA1xx, GRA3xx		P0527		0,02 kg
	standard ball valve with thermometer (1x blue + 1x red)		P0525		0,12 kg
	set of spare thermometers (1x red + 1x blue)		P0526		0,20 kg
11	safety set KSG 2,5 bar - →1" x 3/4"→		P0246		0,71 kg
	safety valve 2,5 bar → 1/2" x 3/4"→		P0257		0,16 kg
	deaerator valve - G3/8" (1/2")		P0394		0,12 kg
	manometer 4 bar - G1/4"		P0259		0,10 kg
12	flat sealing				
	flat sealing 3/4" - 3 mm		S1453		0,01 kg
	flat sealing 1" - 3 mm		S1452		0,01 kg
	flat sealing 6/4" - 3 mm		S1527		0,01 kg
	flat sealing 2" - 3 mm		S1532		0,01 kg
13	plug 6/4"		V0955		0,35 kg
14	brass nipple				
	brass nipple 1" - lenght 35 mm		S1471		0,13 kg
	brass nipple 6/4" - lenght 46 mm		S1535		0,29 kg

F2 Laddomat

P0602







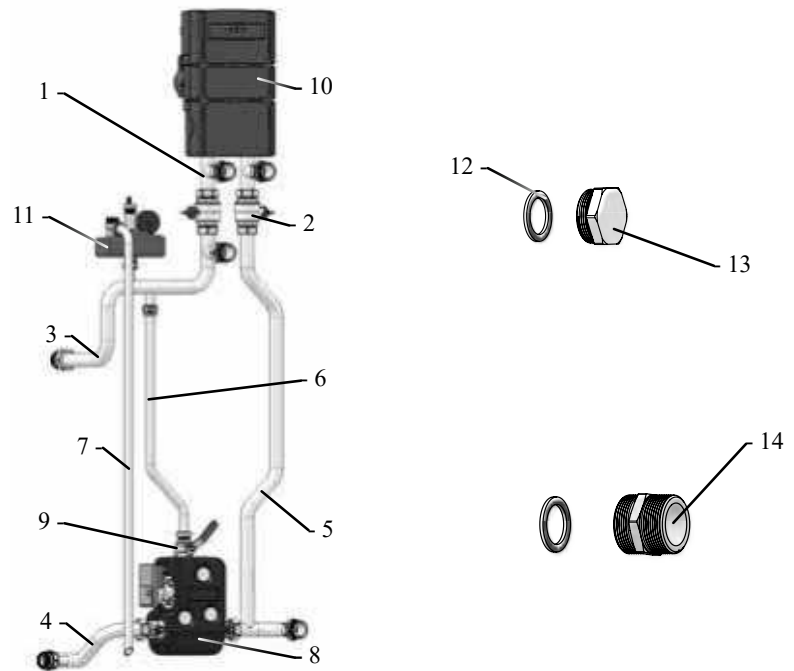

for boilers: DC32S, DC40SX, DC15GS, DC20GS, DC25GS, DC32GS, GS15, GS20, GS25, GS32, DC18GSE, DC22GSE, DC25GSE, DC30GSE, DC18GD, DC25GD, DC30GD





F6 Laddomat

P0606



Spare parts for Connection F2 Laddomat, F6 Laddomat:

Pos.	Name		Code	Price	Weight
1	T part Ø 35		S1519		0,60 kg
2	ball valve WESA - 6/4" - outer thread		P0532		1,02 kg
3	branch Ø 35 - outlet pipe from the boiler		S1518		1,70 kg
4	pipe Ø 35 - return to boiler for assembly with Laddomat X22 (with branch for expansion tank)		S1520		0,80 kg
5	connection pipe Ø 35 - return from system and tank for assembly with Laddomat X22		S1525		2,12 kg
6	connection pipe Ø 22 (shortcut) for assembly with Laddomat X22		S1517		0,70 kg
7	safety valve pipe Ø 18for assembly with Laddomat X22		S1512		0,xx kg
8	Laddomat X22		P0247		5,60 kg
9	fitting / ball valve 2"/1" - outer thread		P0254		0,60 kg
Another spare parts for Laddomat can be found on page 63.					

10	Circulation unit ATMOS/ESBE GRA 211 mixing (without servo actuator, only with knob) - spacing 125 mm - 6/4" / 1" - (1x40 kW) - with connector and cable for a pump		P0538		6,40 kg
	spare pump		P0521		1,88 kg
	a set (heart) of a three-way valve with accessories - renovation kit		P0528		0,04 kg
	three-way valve knob for GRA1xx, GRA3xx		P0527		0,02 kg
	standard ball valve with thermometer (1x blue + 1x red)		P0525		0,12 kg
	set of spare thermometers (1x red + 1x blue)		P0526		0,20 kg
11	safety set KSG 2,5 bar - →1" x 1"→		P0249		0,72 kg
	safety valve 2,5 bar →3/4" x 1"→		P0258		0,18 kg
	deaerator valve - G3/8" (1/2")		P0394		0,12 kg
	manometer 4 bar - G1/4"		P0259		0,10 kg
12	flat sealing				
	flat sealing 1" - 3 mm		S1452		0,01 kg
	flat sealing 6/4" - 3 mm		S1527		0,01 kg
	flat sealing 2" - 3 mm		S1532		0,01 kg
13	plug 6/4"		V0955		0,35 kg
14	brass nipple				
	brass nipple 1" - lenght 35 mm		S1471		0,13 kg
	brass nipple 6/4" - lenght 46 mm		S1535		0,29 kg

F3 ESBE

P0603





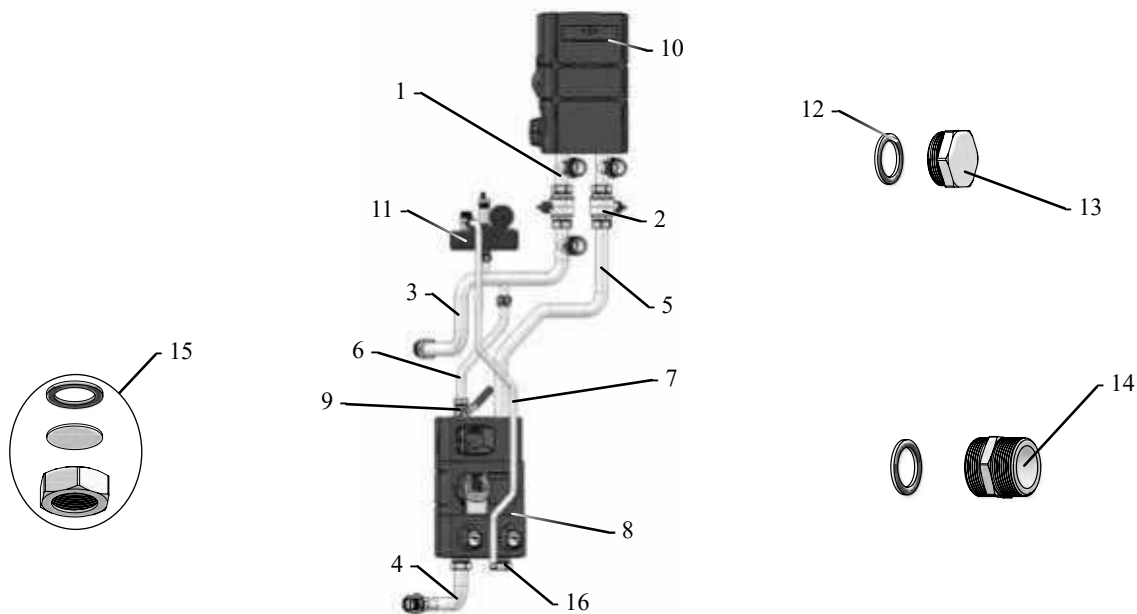

for boilers: DC18S, DC22S, DC22SX, DC25S, DC30SX, KC16S, KC25S, C15S, C18S, AC16S, AC25S







F7 ESBE

P0607



Spare parts for Connection F3 ESBE, F7 ESBE:

Pos.	Name		Code	Price	Weight
1	T part Ø 35		S1519		0,60 kg
2	ball valve WESA - 6/4" - outer thread		P0532		1,02 kg
3	branch Ø 35 - outlet pipe from the boiler		S1518		1,70 kg
4	pipe Ø 35 - return to the boiler for assembly with circulation unit ESBE (with branch for expansion tank)		S1521		0,80 kg
5	connection pipe Ø 35 - return to the boiler for assembly with circulation unit ESBE		S1522		1,30 kg
6	connection pipe Ø 22 (shortcut) for assembly with circulation unit ESBE		S1515		0,40 kg
7	safety valve pipe Ø 18 for assembly with circulation unit ESBE		S1511		0,50 kg

8	circulation unit ATMOS/ESBE GSA 211 mixing (with servo actuator 60 s) - spacing 125 mm - 6/4" / 1" - (1x40 kW) - with connector and cable for pump		P0511		6,50 kg
9	ball valve for ATMOS / ESBE GSA211 fittings into the shortcut of the boiler circuit 1" / 6/4"		P0248		0,34 kg
	servo actuator ESBE ARA651 - 230 V - 60 s - 6 Nm		P0517		0,50 kg
	spare pump		P0521		1,88 kg
	a set (heart) of a tree-way valve with accessories - renovation kit		P0528		0,04 kg
	special ball valve with thermometer, pointer turned by 180 degree (1x blue + 1x red)		P0524		0,95 kg
	set of spare thermometers (1x red + 1x blue)		P0526		0,20 kg
16	brass reducing nipple 1" / 6/4" - lenght 64 mm		S1438		0,50 kg
10	circulation unit ATMOS/ESBE GRA 211 mixing (with servo actuator 120 s) - spacing 125 mm - 6/4" / 1" - (1x40 kW) - with connector and cable for a pump		P0514		6,50 kg
	spare pump		P0521		1,88 kg
	servo actuator ESBE ARA661 - 230 V - 120 s - 6 Nm		P0515		0,50 kg
	a set (heart) three-way valve with accessories - renovation kit		P0528		0,04 kg
	standard ball valve with thermometer (1x blue + 1x red)		P0525		0,12 kg
	set of spare thermometers (1x red + 1x blue)		P0526		0,20 kg
11	safety set KSG 2,5 bar - →1" x 3/4"→		P0246		0,71 kg
	safety valve 2,5 bar → 1/2" x 3/4"→		P0257		0,16 kg
	deaerator valve - G3/8" (1/2")		P0394		0,12 kg
	manometer 4 bar - G1/4"		P0259		0,10 kg
12	flat sealing				
	flat sealing 3/4" - 3 mm		S1453		0,01 kg
	flat sealing 1" - 3 mm		S1452		0,01 kg
	flat sealing 6/4" - 3 mm		S1527		0,01 kg
	flat sealing 2" - 3 mm		S1532		0,01 kg
13	plug 6/4"		V0955		0,35 kg
14	brass nipple				
	brass nipple 1" - lenght 35 mm		S1471		0,13 kg
	brass nipple 6/4" - lenght 46 mm		S1535		0,29 kg
15	a set of nut 6/4" with stainless steel washer and sealing (6/4" - 3 mm) - intended for closing the free inlet of the ESBE fitting in the boiler circuit (connection without storage tank)		P0539		1,00 kg
	brass nut 6/4" (height 15,5 mm)		S1549		0,08 kg
	stainless steel sealing washer - Ø 44,5 mm		S1408		0,02 kg

F4 ESBE

P0604





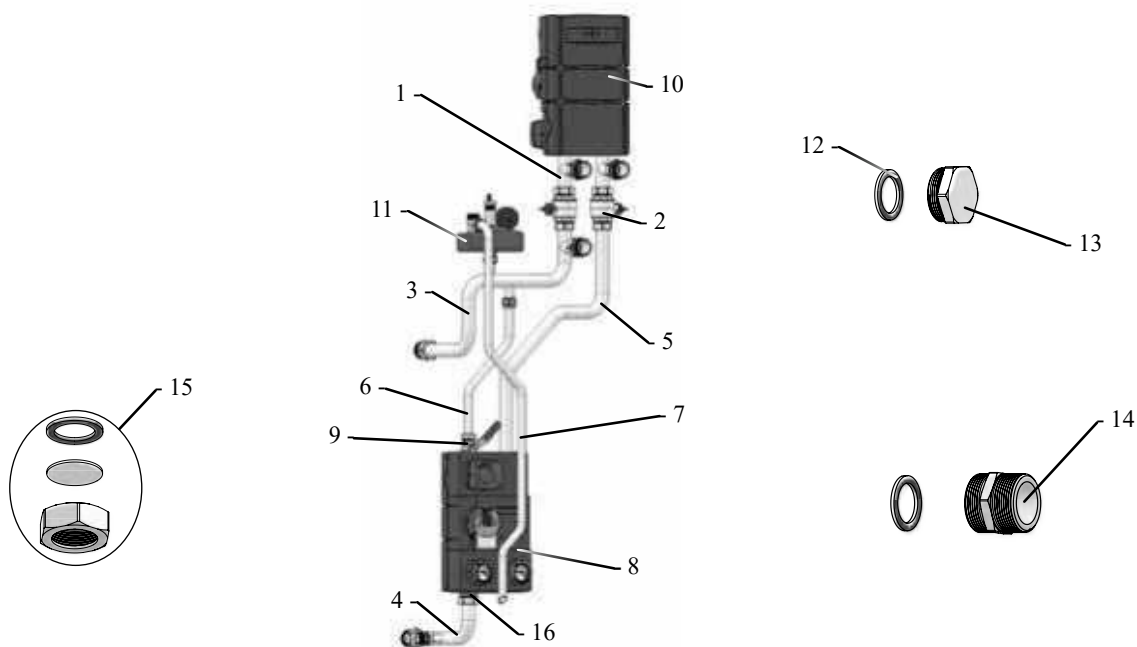

for boilers: DC32S, DC40SX, DC15GS, DC20GS, DC25GS, DC32GS, GS15, GS20, GS25, GS32, DC18GSE, DC22GSE, DC25GSE, DC30GSE, DC18GD, DC25GD, DC30GD







F8 ESBE

P0608



Spare parts for Connection F4 ESBE, F8 ESBE:

Pos.	Name		Code	Price	Weight
1	T part Ø 35		S1519		0,60 kg
2	ball valve WESA - 6/4" - outer thread		P0532		1,02 kg
3	branch Ø 35 - outlet pipe from the boiler		S1518		1,70 kg
4	pipe Ø 35 - return to the boiler for assembly with circulation unit ESBE (with branch for expansion tank)		S1521		0,80 kg
5	connection pipe Ø 35 - return to the boiler for assembly with circulation unit ESBE		S1524		1,40 kg
6	connection pipe Ø 22 (shortcut) for assembly with circulation unit ESBE		S1516		0,50 kg
7	safety valve pipe Ø 18 for assembly with circulation unit ESBE		S1513		0,90 kg

8	circulation unit ATMOS/ESBE GSA 211 mixing (with servo actuator 60 s) - spacing 125 mm - 6/4" / 1" - (1x40 kW) - with connector and cable for pump		P0511		6,50 kg
9	ball valve for ATMOS / ESBE GSA211 fittings into the shortcut of the boiler circuit 1" / 6/4"		P0248		0,34 kg
	servo actuator ESBE ARA651 - 230 V - 60 s - 6 Nm		P0517		0,50 kg
	spare pump		P0521		1,88 kg
	a set (heart) of a tree-way valve with accessories - renovation kit		P0528		0,04 kg
	special ball valve with thermometer, pointer turned by 180 degree (1x blue + 1x red)		P0524		0,95 kg
	set of spare thermometers (1x red + 1x blue)		P0526		0,20 kg
16	brass reducing nipple 1" / 6/4" - lenght 64 mm		S1438		0,50 kg
10	circulation unit ATMOS/ESBE GRA 211 mixing (with servo actuator 120 s) - spacing 125 mm - 6/4" / 1" - (1x40 kW) - with connector and cable for a pump		P0514		6,50 kg
	spare pump		P0521		1,88 kg
	servo actuator ESBE ARA661 - 230 V - 120 s - 6 Nm		P0515		0,50 kg
	a set (heart) three-way valve with accessories - renovation kit		P0528		0,04 kg
	standard ball valve with thermometer (1x blue + 1x red)		P0525		0,12 kg
	set of spare thermometers (1x red + 1x blue)		P0526		0,20 kg
11	safety set KSG 2,5 bar - →1" x 1"→		P0249		0,72 kg
	safety valve 2,5 bar → 1/2" x 3/4"→		P0258		0,18 kg
	deaerator valve - G3/8" (1/2")		P0394		0,12 kg
	manometer 4 bar - G1/4"		P0259		0,10 kg
12	flat sealing				
	flat sealing 1" - 3 mm		S1452		0,01 kg
	flat sealing 6/4" - 3 mm		S1527		0,01 kg
	flat sealing 2" - 3 mm		S1532		0,01 kg
13	plug 6/4"		V0955		0,35 kg
14	brass nipple				
	brass nipple 1" - lenght 35 mm		S1471		0,13 kg
	brass nipple 6/4" - lenght 46 mm		S1535		0,29 kg
15	a set of nut 6/4" with stainless steel washer and sealing (6/4" - 3 mm) - intended for closing the free inlet of the ESBE fitting in the boiler circuit (connection without storage tank)		P0539		1,00 kg
	brass nut 6/4" (height 15,5 mm)		S1549		0,08 kg
	stainless steel sealing washer - Ø 44,5 mm		S1408		0,02 kg

F12 Laddomat

P0612

for boilers: DC18S, DC22S, DC22SX, DC25S, DC30SX, KC16S, KC25S, C15S, C18S, AC16S, AC25S
 DC32S, DC40SX, DC15GS, DC20GS, DC25GS, DC32GS, GS15, GS20, GS25, GS32,
 DC18GSE, DC22GSE, DC25GSE, DC30GSE, DC18GD, DC25GD, DC30GD
 C25ST, C32ST, KC35S, DC18SP, DC25SP, DC30SPX, DC32SP





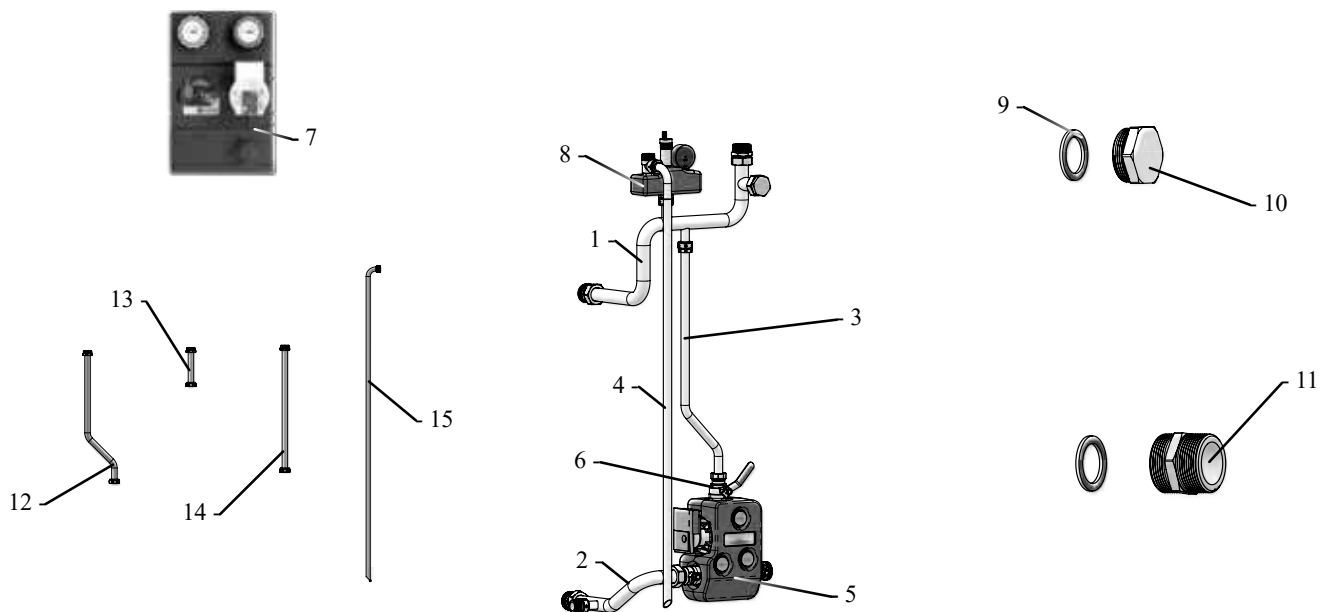



F13 Laddomat

P0613



Spare parts for Connection F12 Laddomat, F13 Laddomat:

Pos.	Name		Code	Price	Weight
1	branch Ø 35 - outlet pipe from the boiler		S1518		1,70 kg
2	pipe Ø 35 - return to the boiler for assembly with Laddomatem X22 (with branch for expansion tank)		S1520		0,80 kg
3	connection pipe Ø 22 (shortcut) for assembly with Laddomatem X22		S1517		0,70 kg
4	safety valve pipe Ø 18 for assembly with Laddomatem X22		S1512		0,xx kg
5	Laddomat X22		P0247		5,60 kg
6	fitting / ball valve 2"/1" - outer thread		P0254		0,60 kg
Another spare parts for Laddomat can be found on page 63.					
7	Circulation unit ATMOS/ESBE GRA 211 mixing (without servo actuator, only with knob) - spacing 125 mm - 6/4" / 1" - (1x40 kW) - with connector and cable for a pump		P0538		6,40 kg
	spare pump		P0521		1,88 kg
	a set (heart) of a three-way valve with accessories - renovation kit		P0528		0,04 kg
	three-way valve knob for GRA1xx, GRA3xx		P0527		0,02 kg
	standard ball valve with thermometer (1x blue + 1x red)		P0525		0,12 kg
	set of spare thermometers (1x red + 1x blue)		P0526		0,20 kg

8	safety set KSG 2,5 bar - →1" x 1"→		P0249		0,72 kg
	safety valve 2,5 bar →3/4" x 1"→		P0258		0,18 kg
	deaerator valve - G3/8" (1/2")		P0394		0,12 kg
	manometer 4 bar - G1/4"		P0259		0,10 kg
9	flat sealing				
	flat sealing 1" - 3 mm		S1452		0,01 kg
	flat sealing 6/4" - 3 mm		S1527		0,01 kg
	flat sealing 2" - 3 mm		S1532		0,01 kg
10	plug 6/4"		V0955		0,35 kg
11	brass nipple				
	brass nipple 1" - lenght 35 mm		S1471		0,13 kg
	brass nipple 6/4" - lenght 46 mm		S1535		0,29 kg
12	connection pipe Ø 22 (shortcut) for assembly with Laddomatem X22		S1514		0,60 kg
13	extension pipe Ø 22 x 144		S1554		0,22 kg
14	extension pipe Ø 22 x 497		S1563		0,48 kg
15	safety valve pipe Ø 22 for boilers DCxxSP		S1564		1,28 kg





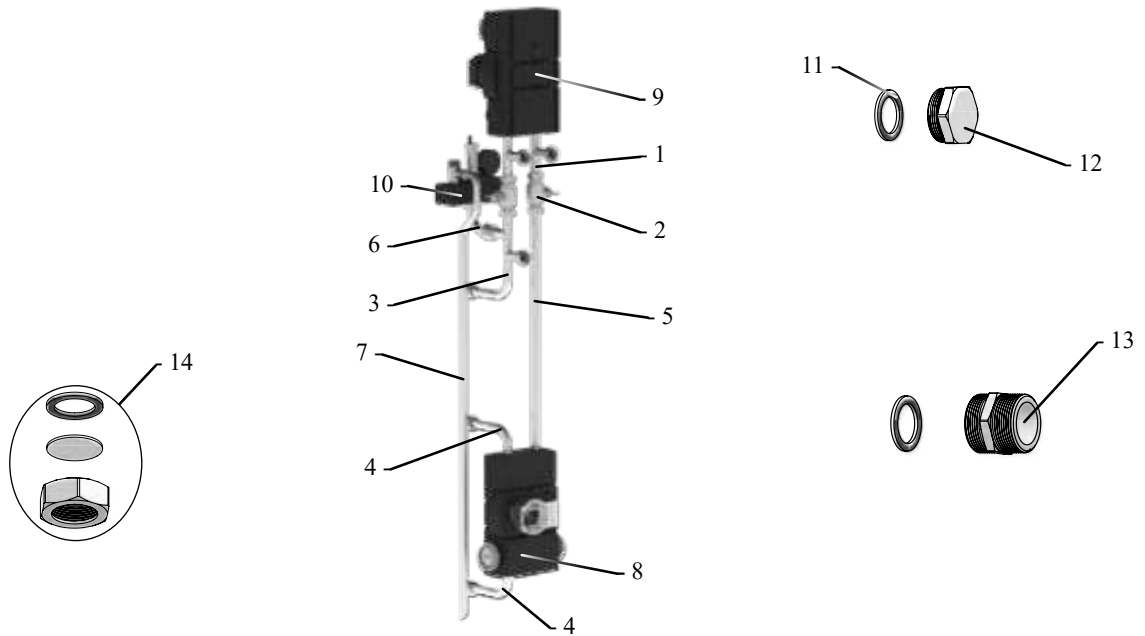

Connection for boilers DxxP Compact







P0251

for boilers: D14P Compact, D21P Compact, D25P Compact



Spare parts for Connection DxxP Compact:

Pos.	Name		Code	Price	Weight
1	T part Ø 22		S1468		0,30 kg
2	ball valve WESA - 1" - outer thread		P0531		0,50 kg
3	branch Ø 22 - outlet pipe from the boiler		S1467		0,50 kg
4	connection pipe Ø 22 - (shortcut) / return to the boiler		S1466		0,30 kg
5	connection pipe Ø 22 - return from the system and accumulation tank		S1469		0,60 kg
6	pipe Ø 22 - safety valve arch		S1465		0,40 kg
7	safety valve pipe Ø 18		S1470		0,50 kg

8	Circulation unit ATMOS/ESBE GFA321 (boiler circuit) - thermostatic 70 °C - spacing 90 mm - 1" / 1" - (1x25 kW)		P0509		4,20 kg
	spare set of thermostatic cartridge 70 °C (VTC 418 - inner body + thermostatic cartridge 70 °C + spring)		P0530		
	spare thermostatic cartridge 70 °C		P0529		0,02 kg
	spare pump		P0520		1,88 kg
	special ball valve with thermometer pointer turned by 180 °- thermometer by 90 ° (1x blue + 1x red)		P0523		0,82 kg
	set of spare thermometers (1x red + 1x blue)		P0526		0,20 kg
9	Circulation unit ATMOS/ESBE GRA311 mixing (system circuit) (without servo actuator, only with knob) - spacing 90 mm - 1" / 1" - (1x25/40 kW)		P0533		4,10 kg
	spare pump		P0520		1,88 kg
	a set (heart) of a tree-way valve with accessories - renovation kit		P0528		0,04 kg
	three-way valve knob		P0527		0,02 kg
	standard ball valve with thermometer (1x blue + 1x red)		P0522		0,82 kg
	set of spare thermometers (1x red + 1x blue)		P0526		0,20 kg
10	safety set KSG 2,5 bar - →1" x 3/4"→		P0246		0,71 kg
	safety valve 2,5 bar → 1/2" x 3/4"→		P0257		0,16 kg
	deaerator valve - G3/8" (1/2")		P0394		0,12 kg
	manometer 4 bar - G1/4"		P0259		0,10 kg
11	flat sealing				
	flat sealing 3/4" - 3 mm		S1453		0,01 kg
	flat sealing 1" - 3 mm		S1452		0,01 kg
12	plug 1"		V0953		0,12 kg
13	brass nipple 1" - lenght 35 mm		S1471		0,13 kg
14	a set of nut 1" with stainless steel washer and sealing (1" - 3 mm) - intended for closing the free inlet of the ESBE fitting in the boiler circuit (connection without storage tank)		P0535		0,06 kg
	brass nut 1"		S1498		0,04 kg
	stainless steel sealing washer - Ø 30 mm		S1613		0,01 kg
15	pipe insulation Kaiflex ST 19x22-SK - lenght 2 m semi-finished product for pipe insulation DxxP Compact (temperature range of use : -50 až 110 °C)		S1489		0,25 kg





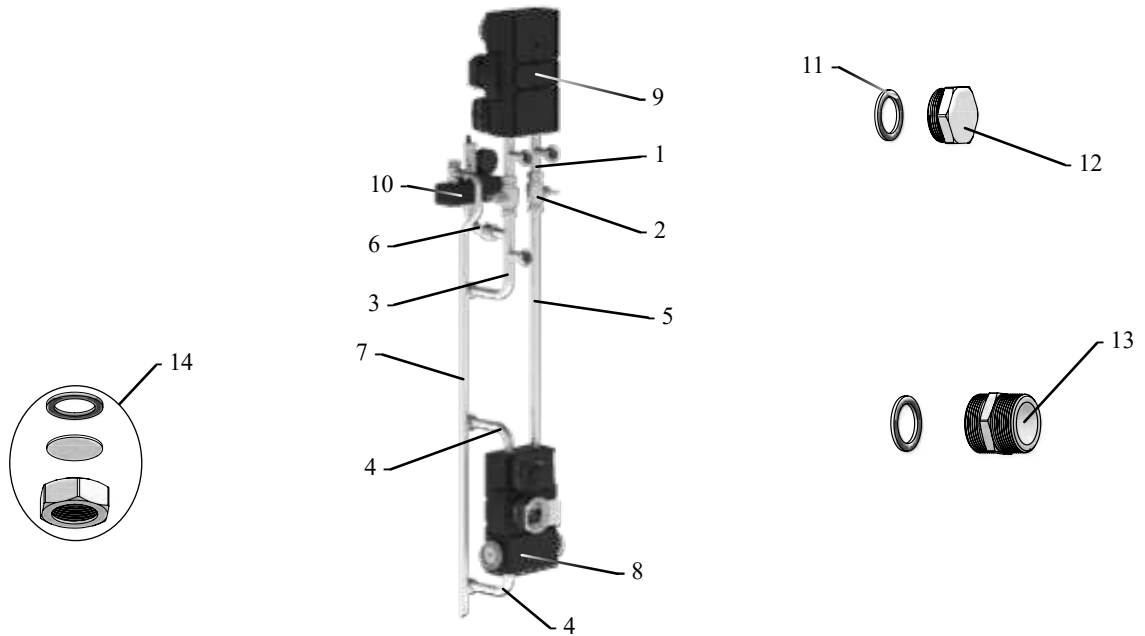

Connection for boilers Pxx Compact







P0252

for boilers: P14 Compact, P21 Compact, P25 Compact



Spare parts for Connection Pxx Compact:

Pos.	Name		Code	Price	Weight
1	T part Ø 22		S1468		0,30 kg
2	ball valve WESA - 1" - outer thread		P0531		0,50 kg
3	branch Ø 22 - outlet pipe from the boiler		S1467		0,50 kg
4	connection pipe Ø 22 - (shortcut) / return to the boiler		S1466		0,30 kg
5	connection pipe Ø 22 - return from the system and accumulation tank		S1469		0,60 kg
6	pipe Ø 22 - safety valve arch		S1465		0,40 kg
7	safety valve pipe Ø 18		S1470		0,50 kg

8	Circulation unit ATMOS/ESBE GSA311 (boiler circuit) - mixing (with servo actuator 60 s) - spacing 90 mm - 1" / 1" - (1x25 kW)		P0508		4,60 kg
	a set (heart) of a tree-way valve with accessories - renovation kit		P0528		0,04 kg
	servo actuator ESBE ARA651 - 230 V - 60 s - 6 Nm		P0517		0,50 kg
	spare pump		P0520		1,88 kg
	special ball valve with thermometer pointer turned by 180 °- thermometer by 90 ° (1x blue + 1x red)		P0523		0,82 kg
	set of spare thermometers (1x red + 1x blue)		P0526		0,20 kg
10	Circulation unit ATMOS/ESBE GRA311 směšovaná (systémový okruh) (with servo actuator 120 s) - spacing 90 mm - 1" / 1" - (1x25/40 kW)		P0505		4,60 kg
	servo actuator ESBE ARA661 - 230 V - 120 s - 6 Nm		P0515		0,50 kg
	spare pump		P0520		1,88 kg
	a set (heart) of a tree-way valve with accessories - renovation kit		P0528		0,04 kg
	standard ball valve with thermometer (1x blue + 1x red)		P0522		0,82 kg
	set of spare thermometers (1x red + 1x blue)		P0526		0,20 kg
11	safety set KSG 2,5 bar - →1" x 3/4"→		P0246		0,71 kg
	safety valve 2,5 bar → 1/2" x 3/4"→		P0257		0,16 kg
	deaerator valve - G3/8" (1/2")		P0394		0,12 kg
	manometer 4 bar - G1/4"		P0259		0,10 kg
12	flat sealing				
	flat sealing 3/4" - 3 mm		S1453		0,01 kg
	flat sealing 1" - 3 mm		S1452		0,01 kg
13	plug 1"		V0953		0,12 kg
14	brass nipple 1" - lenght 35 mm		S1471		0,13 kg
15	a set of nut 1" with stainless steel washer and sealing (1" - 3 mm) - intended for closing the free inlet of the ESBE fitting in the boiler circuit (connection without storage tank)		P0535		0,06 kg
	brass nut 1"		S1498		0,04 kg
	stainless steel sealing washer - Ø 30 mm		S1613		0,01 kg
16	pipe insulation Kaiflex ST 19x22-SK - lenght 2 m semi-finished product for pipe insulation DxxP Compact (temperature range of use : -50 až 110 °C)		S1489		0,25 kg

F15 ESBE-PX

P0615





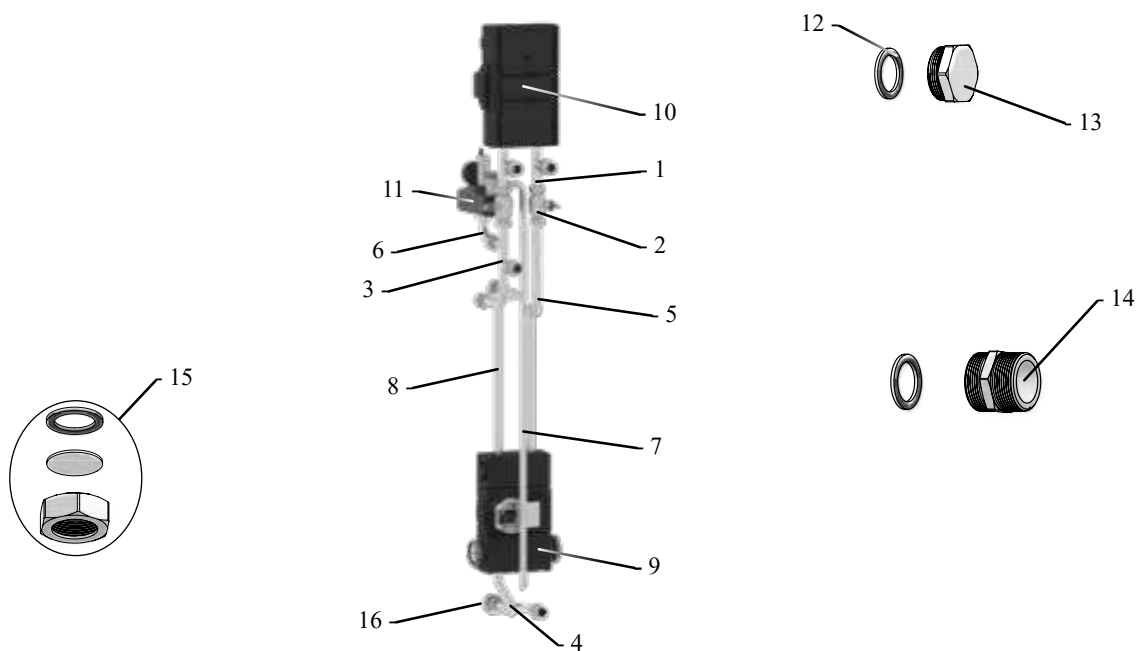

for boilers: D10PX, PX10







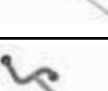

F17 ESBE-PX

P0617



spare parts for Connection F15 ESBE-PX, F17 ESBE-PX:

Pos.	Name		Code	Price	Weight
1	T part Ø 22		S1468		0,30 kg
2	ball valve WESA - 1" - outer thread		P0531		0,50 kg
3	branch Ø 22 - outlet pipe from the boiler		S1467		0,50 kg
4	pipe Ø 22 - return to boiler (with branch for expansion tank)		S1556		0,42 kg
5	connection pipe Ø 22 - return from system and tank		S1558		0,64 kg
6	pipe Ø 22 - safety valve arch		S1465		0,40 kg
7	safety valve pipe Ø 18		S1559		0,45 kg
8	connection pipe Ø 22 (shortcut)		S1557		0,66 kg

9	Circulation unit ATMOS/ESBE GFA321 (boiler circuit) - thermostatic 70 °C - spacing 90 mm - 1" / 1" - (1x25 kW)		P0509		4,20 kg
	spare set of thermostatic cartridge 70 °C (VTC 418 - inner body + thermostatic cartridge 70 °C + spring)		P0530		
	spare thermostatic cartridge 70 °C		P0529		0,02 kg
	spare pump		P0520		1,88 kg
	special ball valve with thermometer pointer turned by 180 °- thermometer by 90 ° (1x blue + 1x red)		P0523		0,82 kg
	set of spare thermometers (1x red + 1x blue)		P0526		0,20 kg
10	Circulation unit ATMOS/ESBE GRA311 mixing (system circuit) (without servo actuator, only with knob) - spacing 90 mm - 1" / 1" - (1x25/40 kW)		P0533		4,10 kg
	spare pump		P0520		1,88 kg
	a set (heart) of a tree-way valve with accessories - renovation kit		P0528		0,04 kg
	three-way valve knob		P0527		0,02 kg
	standard ball valve with thermometer (1x blue + 1x red)		P0522		0,82 kg
	set of spare thermometers (1x red + 1x blue)		P0526		0,20 kg
11	safety set KSG 2,5 bar - →1" x 3/4"→		P0246		0,71 kg
	safety valve 2,5 bar → 1/2" x 3/4"→		P0257		0,16 kg
	deaerator valve - G3/8" (1/2")		P0394		0,12 kg
	manometer 4 bar - G1/4"		P0259		0,10 kg
12	flat sealing				
	flat sealing 3/4" - 3 mm		S1453		0,01 kg
	flat sealing 1" - 3 mm		S1452		0,01 kg
13	plug 1"		V0953		0,12 kg
14	brass nipple 1" - lenght 35 mm		S1471		0,13 kg
15	a set of nut 1" with stainless steel washer and sealing (1" - 3 mm) - intended for closing the free inlet of the ESBE fitting in the boiler circuit (connection without storage tank)		P0535		0,06 kg
	brass nut 1"		S1498		0,04 kg
	stainless steel sealing washer - Ø 30 mm		S1613		0,01 kg
16	special reducing nipple 6/4"→ 1" (steel - galvanized) - lenght 46 mm - for installing the connection to the boiler		S1551		0,37 kg

F16 ESBE-PX

P0618







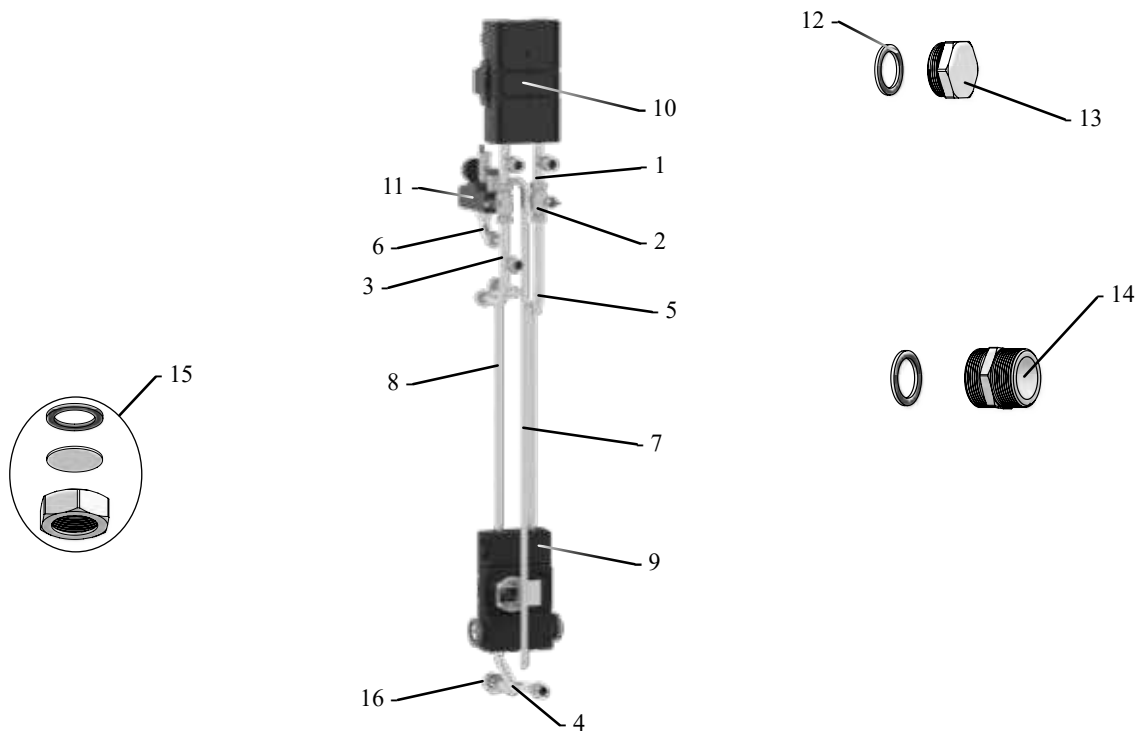

for boilers: D15PX, D20PX, D25PX, PX15, PX20, PX25









F18 ESBE-PX

P0618



Spare parts for Connection F16 ESBE-PX, F18 ESBE-PX:

Pos.	Name		Code	Price	Weight
1	T part Ø 22		S1468		0,30 kg
2	ball valve WESA - 1" - outer thread		P0531		0,50 kg
3	branch Ø 22 - outlet pipe from the boiler		S1467		0,50 kg
4	pipe Ø 22 - return to the boiler (with branch for expansion tank)		S1556		0,42 kg
5	connection pipe Ø 22 - return from system and tank		S1561		0,80 kg
6	pipe Ø 22 - safety valve arch		S1465		0,40 kg
7	safety valve pipe Ø 18		S1562		0,52 kg
8	connection pipe Ø 22 (shortcut)		S1560		0,82 kg

9	Circulation unit ATMOS/ESBE GFA321 (boiler circuit) - thermostatic 70 °C - spacing 90 mm - 1" / 1" - (1x25 kW)		P0509		4,20 kg
	spare set of thermostatic cartridge 70 °C (VTC 418 - inner body + thermostatic cartridge 70 °C + spring)		P0530		
	spare thermostatic cartridge 70 °C		P0529		0,02 kg
	spare pump		P0520		1,88 kg
	special ball valve with thermometer pointer turned by 180 °- thermometer by 90 ° (1x blue + 1x red)		P0523		0,82 kg
	set of spare thermometers (1x red + 1x blue)		P0526		0,20 kg
10	Circulation unit ATMOS/ESBE GRA311 mixing (system circuit) (without servo actuator, only with knob) - spacing 90 mm - 1" / 1" - (1x25/40 kW)		P0533		4,10 kg
	spare pump		P0520		1,88 kg
	a set (heart) of a tree-way valve with accessories - renovation kit		P0528		0,04 kg
	three-way valve knob		P0527		0,02 kg
	standard ball valve with thermometer (1x blue + 1x red)		P0522		0,82 kg
	set of spare thermometers (1x red + 1x blue)		P0526		0,20 kg
11	safety set KSG 2,5 bar - →1" x 3/4"→		P0246		0,71 kg
	safety valve 2,5 bar → 1/2" x 3/4"→		P0257		0,16 kg
	deaerator valve - G3/8" (1/2")		P0394		0,12 kg
	manometer 4 bar - G1/4"		P0259		0,10 kg
12	flat sealing				
	flat sealing 3/4" - 3 mm		S1453		0,01 kg
	flat sealing 1" - 3 mm		S1452		0,01 kg
13	plug 1"		V0953		0,12 kg
14	brass nipple 1" - lenght 35 mm		S1471		0,13 kg
15	a set of nut 1" with stainless steel washer and sealing (1" - 3 mm) - intended for closing the free inlet of the ESBE fitting in the boiler circuit (connection without storage tank)		P0535		0,06 kg
	brass nut 1"		S1498		0,04 kg
	stainless steel sealing washer - Ø 30 mm		S1613		0,01 kg
16	special reducing nipple 6/4"→ 1" (steel - galvanized) - lenght 46 mm - for installing the connection to the boiler		S1551		0,37 kg

Accessories for boilers up to 40 kW with manual stoking

Connection of ATMOS boilers F1-F8

**Circulation unit
ATMOS ESBE GRA211**
Controlled - actuator 120 s
Spacing 125 mm - 1" ↑↓ 6/4"
Recommended for
radiators/underfloor heating
(order code: P0514)

**Circulation unit
ATMOS ESBE GFA211**
Thermostatic 20 - 55 °C
Spacing 125 mm - 1" ↑↓ 6/4"
Recommended for
underfloor heating
(order code: P0513)

**Circulation unit
ATMOS ESBE GDA211**
Direct
Spacing 125 mm - 1" ↑↓ 6/4"
Recommended for
domestic hot water
(order code: P0512)

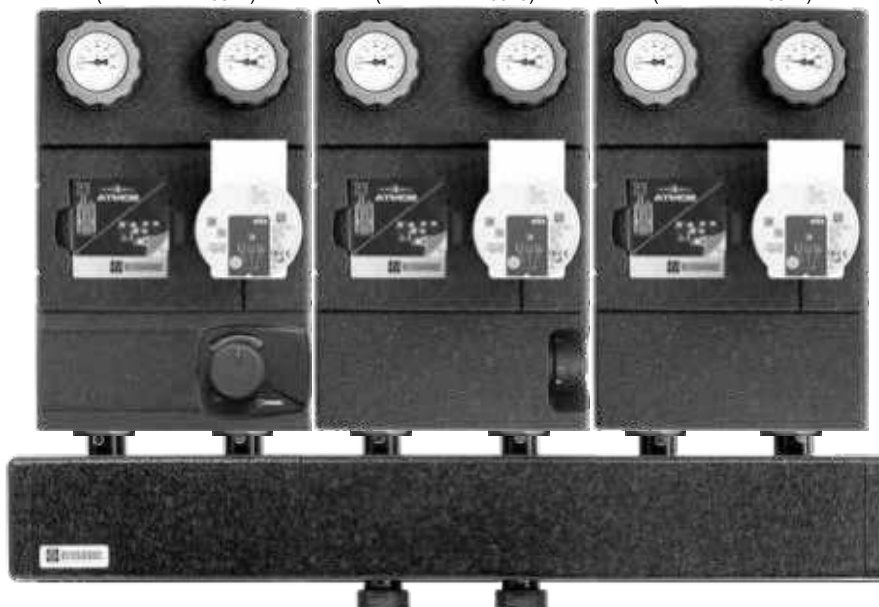

Manifold for three circulation units (three circuits)

ATMOS ESBE GMA431
Spacing 125 mm - 6/4" ↑↓ 6/4"
(order code: P0516)



**Circulation unit
ATMOS ESBE GRA211**
Mixing
Spacing 125 mm - 1" ↑↓ 6/4"
Recommended for
radiators
(order code: P0538)

**Servo actuator
ESBE ARA 661**
230 V - 120 s - 6 Nm
(order code: P0415)



**Manifold for two circulation units
(two circuits)**

ATMOS ESBE GMA421
Spacing 125 mm - 6/4" ↑↓ 6/4"
(order code: P0515)

Name	Code	Price	Weight
Circulation unit ATMOS ESBE GRA211 - mixing - with servo actuator 120 s	P0514		6,00 kg
Circulation unit ATMOS ESBE GRA211 - mixing - without servo actuator	P0538		6,50 kg
Circulation unit ATMOS ESBE GFA211 - thermostatic 20 - 55 °C	P0513		6,40 kg
Spare thermo cartridge (set) 20 - 55 °C for thermostatic valve VTA572 (VTA57x)	P0519		0,02 kg
Circulation unit ATMOS ESBE GDA211 - direct	P0512		5,80 kg
Manifold for two circulation units (two circuits) ATMOS ESBE GMA421	P0515		5,90 kg
Manifold for three circulation units (three circuits) ATMOS ESBE GMA431	P0516		
Servo actuator ESBE ARA 661 - 120 s	P0415		0,50 kg

Accessories for Connection of ATMOS pellet boilers up to 25 kW DxxPX, PXxx (F15-F18), DxxP Compact, Pxx Compact

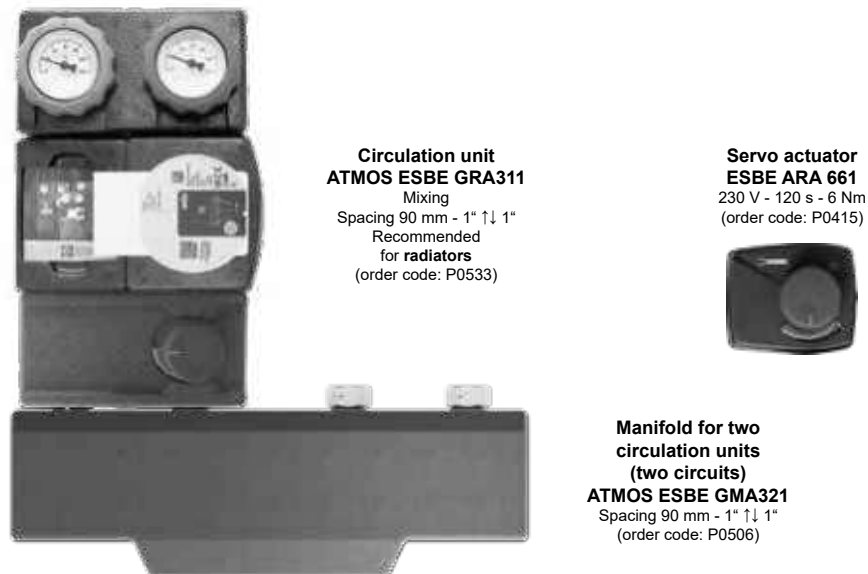
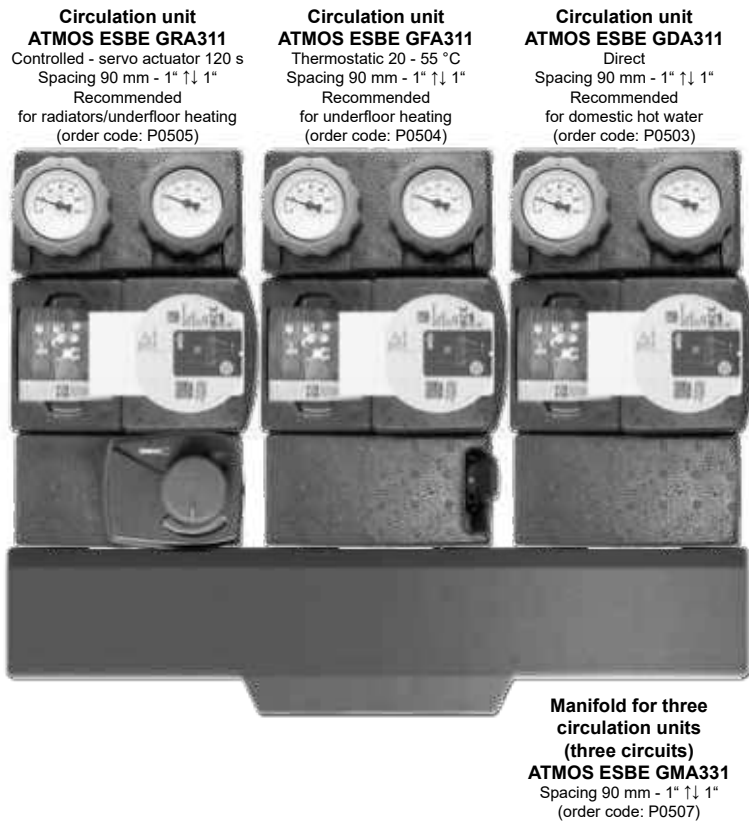

Name	Code	Price	Weight
Circulation unit ATMOS ESBE GRA311 - with servo actuator 120 s	P0505		4,60 kg
Circulation unit ATMOS ESBE GRA211 - without servo actuator	P0533		4,10 kg
Circulation unit ATMOS ESBE GFA311 - thermostatic 20 - 55 °C	P0504		4,00 kg
Spare thermo cartridge (set) 20 - 55 °C for thermostatic valve VTA378 (VTA37x)	P0518		0,02 kg
Circulation unit ATMOS ESBE GDA311- direct	P0503		3,70 kg
Manifold for two circulation unit (two circuits) ATMOS ESBE GMA321	P0507		5,62 kg
Manifold for three circulation units (three circuits) ATMOS ESBE GMA331	P0506		
Servo actuator ESBE ARA 661 - 120 s	P0415		0,50 kg

Special accessories for extending the Connection of boilers

Pipe extension set PSC 25 - 35

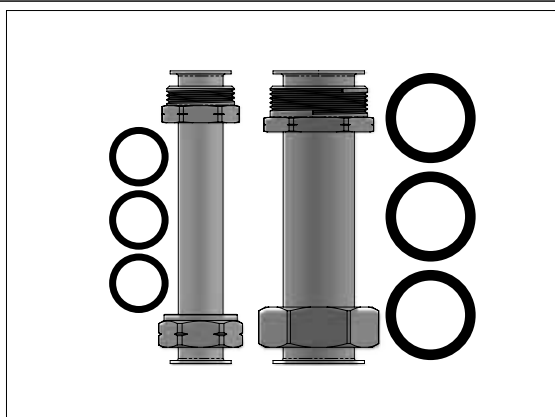

The pipe extension set serves to extend the Connection ATMOS F2 Laddomat (15 - 40 kW) so that it can be used for boilers C25ST and C32ST.

Set contains: 1x connection pipe 22x1,5 / 1x connection pipe 35x1,5 / 3x flat sealing 1" - 3 mm / 3x flat sealing 6/4" - 3 mm.

Code: P0650 extension set of pipes PSC 25 - 35 - for boilers C25ST and C32ST	<i>Price:</i>
	<i>Weight:</i> 0,68 kg

Code: S1554 extension pipe with fitting 1" - Ø 22 - lenght 144 mm	<i>Price:</i>
	<i>Weight:</i> 0,22 kg

Code: S1555 extension pipe with fitting 6/4" - Ø 35 - lenght 144 mm	<i>Price:</i>
	<i>Weight:</i> 0,39 kg

Code: S1452 flat sealing 1" - 3 mm	<i>Price:</i>
	<i>Weight:</i> 0,01 kg

Code: S1527 flat sealing 6/4" - 3 mm	<i>Price:</i>
	<i>Weight:</i> 0,01 kg

Pipe extension set PSC 40 - 50

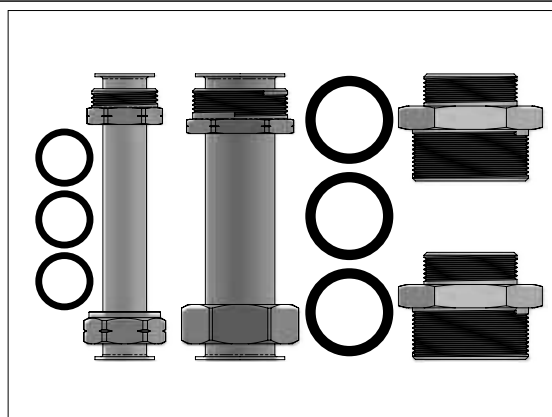

The pipe extension set serves to extend the Connection ATMOS F2 Laddomat (15 - 40 kW) so that it can be used for boilers C40S, DC40GS and GS40.

Set contains: 1x connection pipe 22x1,5 / 1x connection pipe 35x1,5 / 3x flat sealing 1" - 3 mm / 3x flat sealing 6/4" - 3 mm / 2x reducing nipple 2"↔6/4".

Code: P0653 extension set of pipes PSC 40 - 50 - for boilers C40S, DC40GS and GS40	<i>Price:</i>
	<i>Weight:</i> 2,08 kg

Code: S1554 extension pipe with fitting 1" - Ø 22 - lenght 144 mm	<i>Price:</i>
	<i>Weight:</i> 0,22 kg

Code: S1555 extension pipe with fitting 6/4" - Ø 35 - lenght 144 mm	<i>Price:</i>
	<i>Weight:</i> 0,39 kg

Code: S1452 flat sealing 1" - 3 mm	<i>Price:</i>
	<i>Weight:</i> 0,01 kg

Code: S1527 flat sealing 6/4" - 3 mm	<i>Price:</i>
	<i>Weight:</i> 0,01 kg

Code: V0959 reducing nipple 2"↔6/4" - steel	<i>Price:</i>
	<i>Weight:</i> 0,70 kg

Pipe extension set PSGD 40 - 50

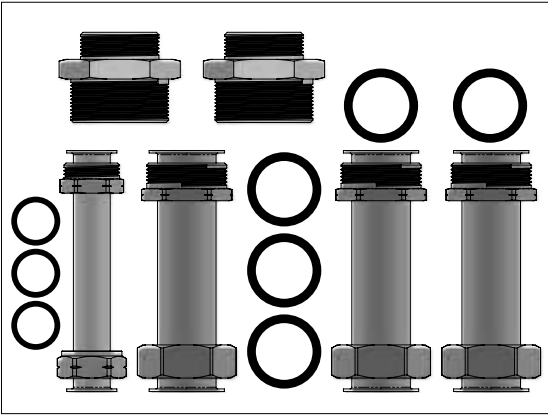

The pipe extension set serves to extend the Connection ATMOS F2 Laddomat (15 - 40 kW) so that it can be used for boilers DC40GD and DC40GSE.

Set contains: 1x connection pipe 22x1,5 / 3x connection pipe 35x1,5 / 3x flat sealing 1" - 3 mm / 5x flat sealing 6/4" - 3 mm / 2x reducing nipple 2" ↔ 6/4".

Code: P0654 extension set of pipes PSGD 40 - 50 - for boilers DC40GD and DC40GSE	<i>Price:</i>
	<i>Weight: 2,88 kg</i>
Code: S1554 extension pipe with fitting 1" - Ø 22 - lenght 144 mm	<i>Price:</i>
	<i>Weight: 0,22 kg</i>
Code: S1555 extension pipe with fitting 6/4" - Ø 35 - lenght 144 mm	<i>Price:</i>
	<i>Weight: 0,39 kg</i>
Code: S1452 flat sealing 1" - 3 mm	<i>Price:</i>
	<i>Weight: 0,01 kg</i>
Code: S1527 flat sealing 6/4" - 3 mm	<i>Price:</i>
	<i>Weight: 0,01 kg</i>
Code: V0959 reducing nipple 2" ↔ 6/4" - steel	<i>Price:</i>
	<i>Weight: 0,70 kg</i>

Pipe elbow set

OSD 15 - 40 - 6/4"

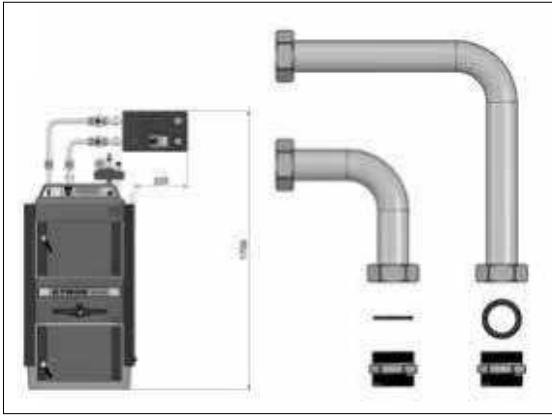

Used to install the circulation unit (with spacing 125 mm) to the horizontal position for boiler rooms with a low ceiling.

Set contains: 1x small elbow 6/4" - Ø 35 mm / 1x large elbow 6/4" - Ø 35 mm / 2x nipple 6/4" / 8x flat sealing 6/4" - 3 mm

with the Connection ATMOS F1 / F5 Laddomat - F3 / F7 ESBE (DC18S, DC22S, DC22SX, DC25S, DC30SX, C15S, C18S, AC16S, AC25S, KC16S, KC25S)

with the Connection ATMOS F2 / F6 Laddomat - F4 / F8 ESBE (DC32S, DC40SX, DC15GS, DC20GS, DC25GS, DC32GS, DC18GD, DC25GD, DC30GD, GS15, GS20, GS25, GS32, DC18GSE, DC22GSE, DC25GSE, DC30GSE)

Code: P0651 Pipe elbow set OSD 15 - 40 - 6/4"	<i>Price:</i>
	<i>Weight:</i> 1,75 kg
Code: S1570 small elbow 6/4" - Ø 35 mm	<i>Price:</i>
	<i>Weight:</i> 0,49 kg
Code: S1571 large elbow 6/4" - Ø 35 mm	<i>Price:</i>
	<i>Weight:</i> 0,78 kg
Code: S1527 flat sealing 6/4" - 3 mm	<i>Price:</i>
	<i>Weight:</i> 0,01 kg
Code: S1567 nipple 6/4"	<i>Price:</i>
	<i>Weight:</i> 0,20 kg

Pipe elbow set

OSP 10 - 25 - 1"

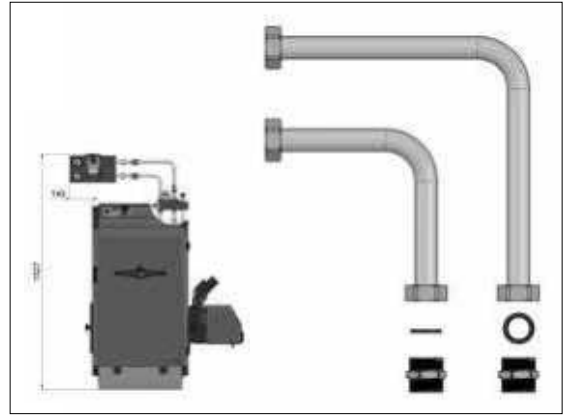

Used to install the circulation unit (with spacing 90 mm) to the horizontal position for boiler rooms with a low ceiling.

Set contains: 1x small elbow 1" - Ø 22 mm / 1x large elbow 1" - Ø 22 mm / 2x nipple 1" / 8x flat sealing 1" - 3 mm

with boiler DxxP Compact and the Connection (D14P Compact, D21P Compact, D25P Compact, P14 Compact, P21 Compact, P25 Compact)

with the Connection ATMOS F15 / F17

(D10PX / PX10)

with the Connection ATMOS F16 / F18

(D10PX, D15PX, D20PX, D25PX, PX10, PX15, PX20, PX25)

Code: P0652 Pipe elbow set OSP 10 - 25 - 1"	<i>Price:</i>
	<i>Weight:</i> 1,02 kg
Code: S1568 small elbow 1" - Ø 22 mm	<i>Price:</i>
	<i>Weight:</i> 0,31 kg
Code: S1569 large elbow 1" - Ø 22 mm	<i>Price:</i>
	<i>Weight:</i> 0,43 kg
Code: S1452 flat sealing 1" - 3 mm	<i>Price:</i>
	<i>Weight:</i> 0,01 kg
Code: S1566 nipple 1"	<i>Price:</i>
	<i>Weight:</i> 0,10 kg