

TACOFLOW3 MAX PRO

HEATING AND COOLING CIRCUIT PUMPS



Glandless circulation pumps for hot water heating, air conditioning, cooling, geothermal and solar thermal systems in residential and commercial buildings.

DESCRIPTION

The TacoFlow3 MAX PRO is driven by permanent-magnet synchronous motors.

These innovative motors achieve a high efficiency at low operating costs.

They are maintenance-free and do not need replacement of seals and gaskets.

INSTALLATION POSITION

The pump can be installed both horizontally or vertically.

The arrow indicating the medium's flow direction must be observed.

ADVANTAGES

- Simple setting of the output curves by means of pushbuttons
- With activeADAPT, variable Δp -v proportional pressure curves, constant pressure curves Δp -c, fixed min. - max. speed and 0-10 V or PWM control
- Media temperature range from -10 °C to +110 °C
- Thermal insulation shell supplied as standard
- Screen for displaying technical information

OPERATION

The circulation pump are of a glandless design, since the rotating parts of the motor run inside the pumped medium. This provides lubrication for the motor and the rotating parts. The circulation pump is equipped with anti-blocking protection, since the high efficiency pumps no longer have a pump head screw for manual unblocking. They also feature an automatic venting function, which detects and indicates any air in the pump.

BUILDING CATEGORIES

- Apartment blocks
- Public buildings
- Hotels and restaurants, industrial kitchens
- School buildings and sports facilities
- Office, commercial and industrial buildings
- Facilities with partial use, such as barracks, camping sites

SYSTEM/BASIC DIAGRAM

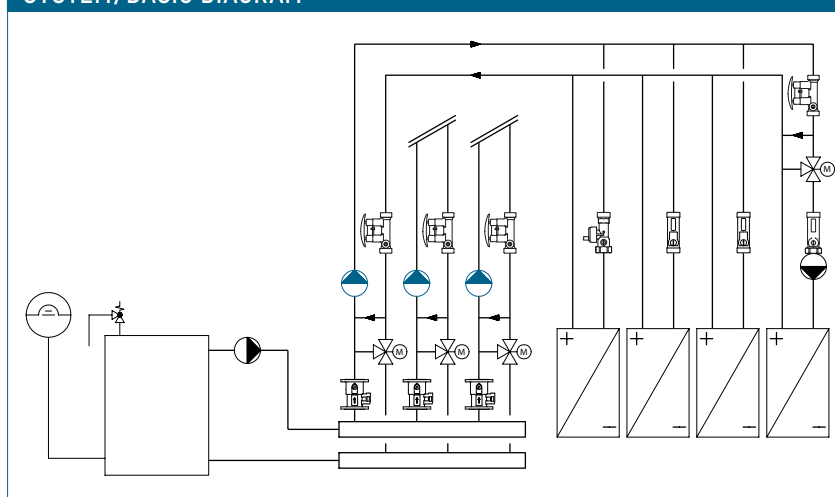

TACOFLOW3 MAX PRO | HEATING AND COOLING CIRCUIT PUMPS

SPECIFICATION TEXT

See www.taconova.com

TECHNICAL DATA

Pump

- Ambient temperature: +0 °C to +40 °C
- Permissible temperature range: -10 °C to +110 °C
- Permissible temperature ranges at max. ambient temperature:
 - at 30 °C: +30 °C to +100 °C
 - at 40 °C: +40 °C to +70 °C
- Static pressure: Max. 1.0 MPa - 10 bar
- Minimum pressure at air intake:
 - 0.05 MPa (0.5 bar) at 80 °C
 - 0.15 MPa (1.5 bar) at 95 °C
- Max. relative humidity: ≤ 80%
- Sound pressure level: < 43 dB (A)
- Low Voltage Directive (2006/95/EC): Standards applied: EN 60335-1 and EN 60335-2-51
- EMC Directive (2004/108/EC); Standards applied: EN 61000-3-2, EN 61000-3-3
- Ecodesign Directive (2009/125/EC); Standards applied: EN 16297-1 and EN 16297-2
- Inputs/outputs: PWM, 0-10 V DC

Material

- Pump body: Cast iron, CDP-coated (EN-GJL-200)
- Impeller: Brass / Composite plastic
- Shaft: Ceramic
- Bearing: Graphite / Ceramic
- Rotor housing: Composite plastic

TECHNICAL DATA (CONTINUED)

Motor and electronics

- Supply voltage: 1x230 V (±10%), PE frequency: 50/60 Hz
- Power rating (P1): Min. 16 W, max. 88 W
- Rated current (I1): Min. 0.2 A, max. 0.6 A
- Insulation class: F
- Protection rating: IP 44
- Temperature class: TF 110

TECHNICAL DATA (CONTINUED)

Fluids

- Heating water (VDI 2035; SWKI BT 102-01; ÖNORM H 5195-1)
- Water and proprietary additives used against corrosion and freezing up to 30 %

TYPE OVERVIEW

TacoFlow3 MAX PRO | Heating and cooling circuit pumps
 Cast iron high efficiency pump with threaded and plug connection.
 Standard thermal insulation shell.
 Pump head: 6 m

Order no.	Designation	G	Centre distance	Weight
302.5239.000	MAX PRO 25-60/180	1 1/2"	180 mm	3.5 kg
302.6239.000	MAX PRO 32-60/180	2"	180 mm	3.5 kg

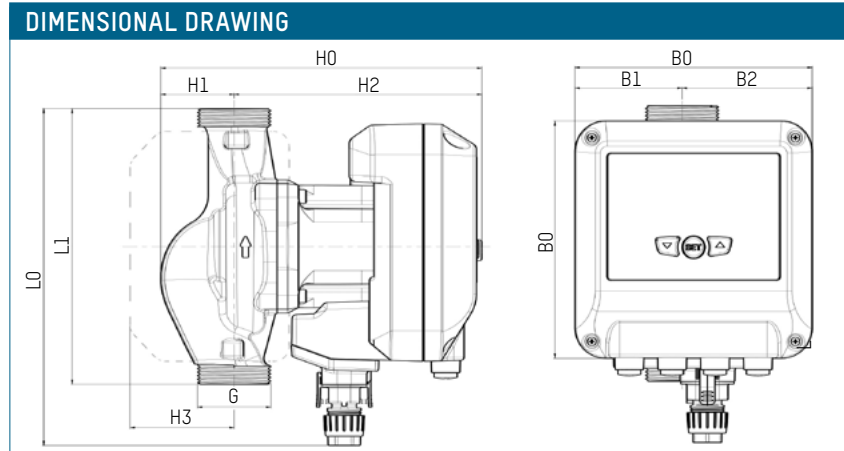

MEASUREMENT TABLE

Order no.	L0	L1	B0	B1	B2	H0	H1	H2	H3
302.5239.000	220	180	155	70	85	207	48	159	68
302.6239.000	220	180	155	70	85	207	48	159	68

ENERGY EFFICIENCY INDEX

EEI ≤ 0,22 - Part 2

Reference value for the most efficient circulation pump is EEI ≤ 0.20

PERFORMANCE CURVES

Operating mode C (Δp -c) – constant differential pressure

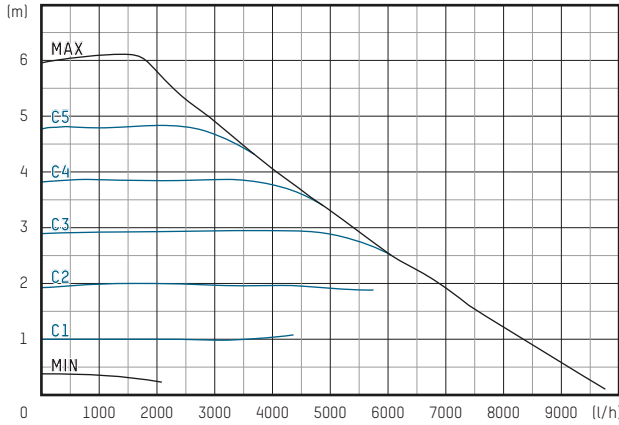

Operating mode P (Δp -v) – variable differential pressure

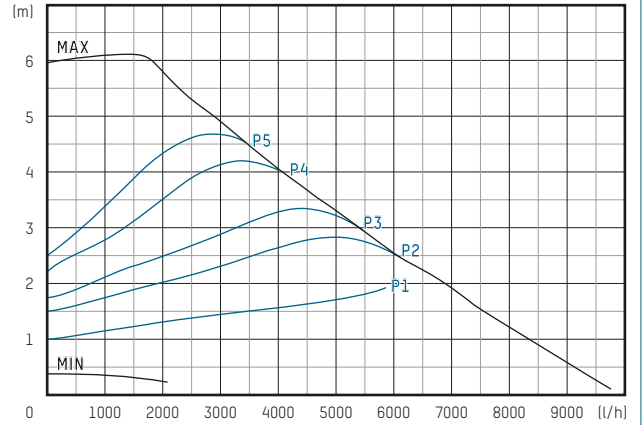

Operating mode activeADAPT – dynamic differential pressure

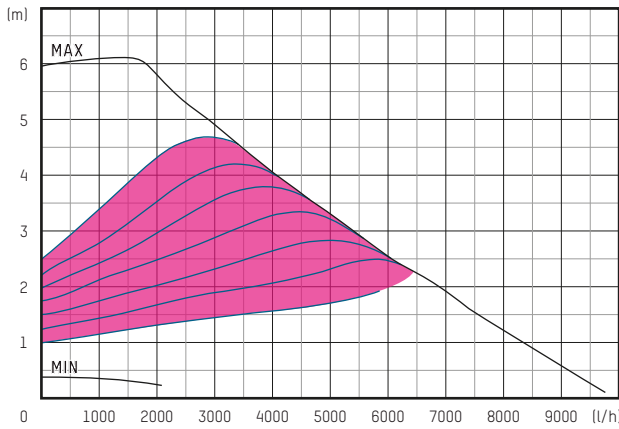

Operating mode 0 – 10 V

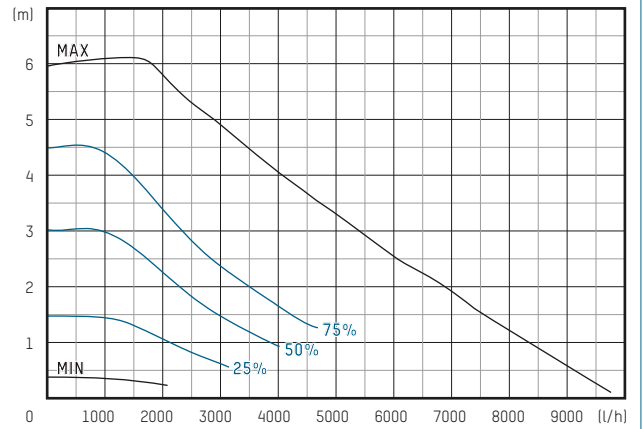

POWER CONSUMPTION CURVES

Operating mode C (Δp -c) – constant differential pressure

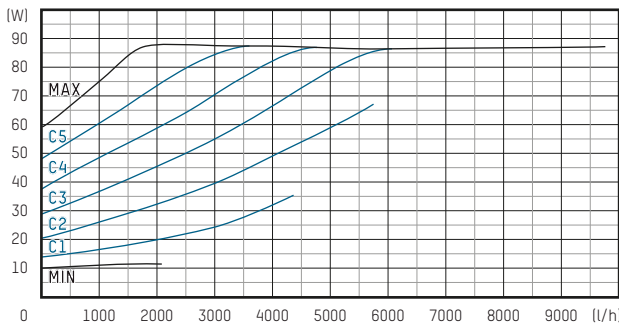

Operating mode P (Δp -v) – variable differential pressure

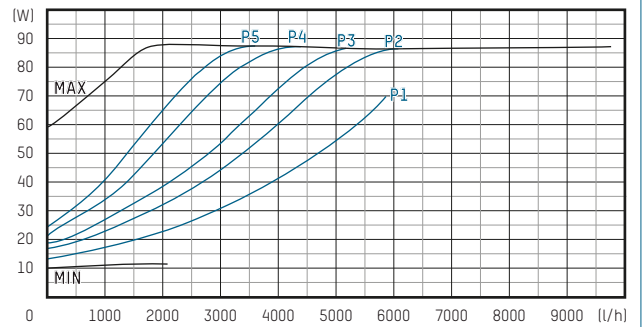

Operating mode activeADAPT – dynamic differential pressure

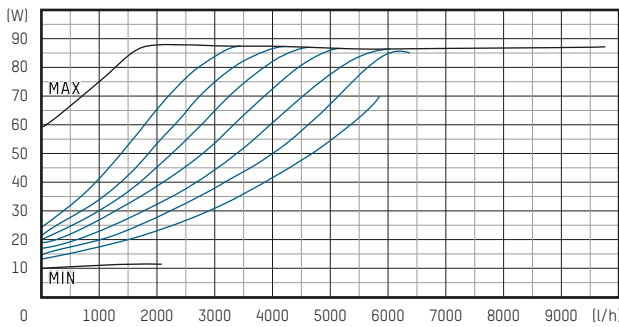

Operating mode 0 – 10 V

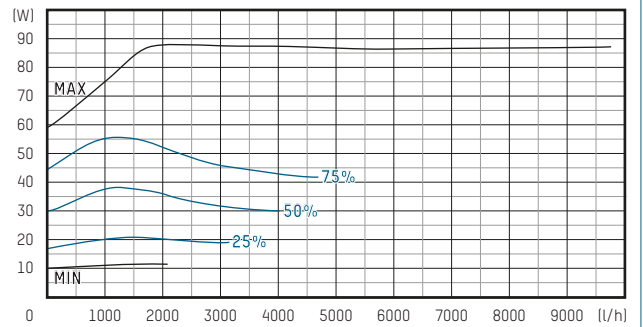

TACOFLOW3 MAX PRO | HEATING AND COOLING CIRCUIT PUMPS

SPECIFICATION TEXT

See www.taconova.com

TECHNICAL DATA

Pump

- Ambient temperature: +0 °C to +40 °C
- Permissible temperature range: -10 °C to +110 °C
- Permissible temperature ranges at max. ambient temperature:
 - at 30 °C: +30 °C to +100 °C
 - at 40 °C: +40 °C to +70 °C
- Static pressure: Max. 1.0 MPa - 10 bar
- Minimum pressure at air intake:
 - 0.05 MPa (0.5 bar) at 80 °C
 - 0.15 MPa (1.5 bar) at 95 °C
- Max. relative humidity: ≤ 80%
- Sound pressure level: < 43 dB (A)
- Low Voltage Directive (2006/95/EC): Standards applied: EN 60335-1 and EN 60335-2-51
- EMC Directive (2004/108/EC); Standards applied: EN 61000-3-2, EN 61000-3-3
- Ecodesign Directive (2009/125/EC); Standards applied: EN 16297-1 and EN 16297-2
- Inputs/outputs: PWM, 0-10 V DC

Material

- Pump body: Cast iron, CDP-coated (EN-GJL-200)
- Impeller: Brass / Composite plastic
- Shaft: Ceramic
- Bearing: Graphite / Ceramic
- Rotor housing: Composite plastic

TECHNICAL DATA (CONTINUED)

Motor and electronics

- Supply voltage: 1x230 V (±10%), PE frequency: 50/60 Hz
- Power rating (P1): Min. 16 W, max. 122 W
- Rated current (I1): Min. 0.2 A, max. 0.8 A
- Insulation class: F
- Protection rating: IP 44
- Temperature class: TF 110

TECHNICAL DATA (CONTINUED)

Fluids

- Heating water (VDI 2035; SWKI BT 102-01; ÖNORM H 5195-1)
- Water and proprietary additives used against corrosion and freezing up to 30 %

TYPE OVERVIEW

TacoFlow3 MAX PRO | Heating and cooling circuit pumps
Cast iron high efficiency pump with threaded and plug connection.
Standard thermal insulation shell.
Pump head: 8 m

Order no.	Designation	G	Centre distance	Weight
302.5259.000	MAX PRO 25-80/180	1 1/2"	180 mm	3.5 kg
302.6259.000	MAX PRO 32-80/180	2"	180 mm	3.5 kg

DIMENSIONAL DRAWING

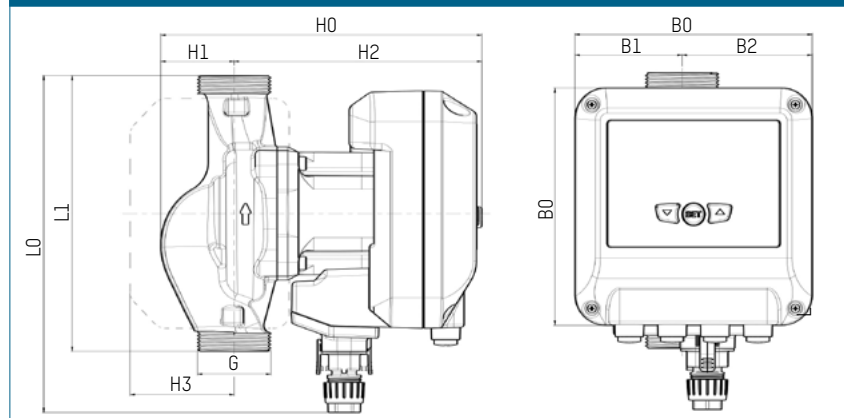

MEASUREMENT TABLE

Order no.	L0	L1	B0	B1	B2	H0	H1	H2	H3
302.5259.000	220	180	155	70	85	207	48	159	68
302.6259.000	220	180	155	70	85	207	48	159	68

ENERGY EFFICIENCY INDEX

EEI ≤ 0,22 - Part 2

Reference value for the most efficient circulation pump is EEI ≤ 0.20

PERFORMANCE CURVES

Operating mode C (Δp -c) – constant differential pressure

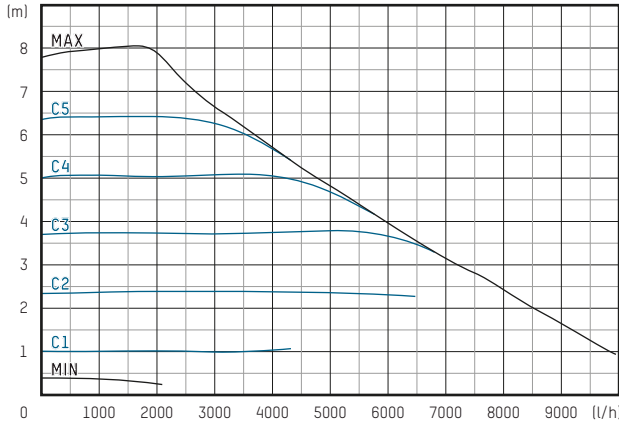

Operating mode P (Δp -v) – variable differential pressure

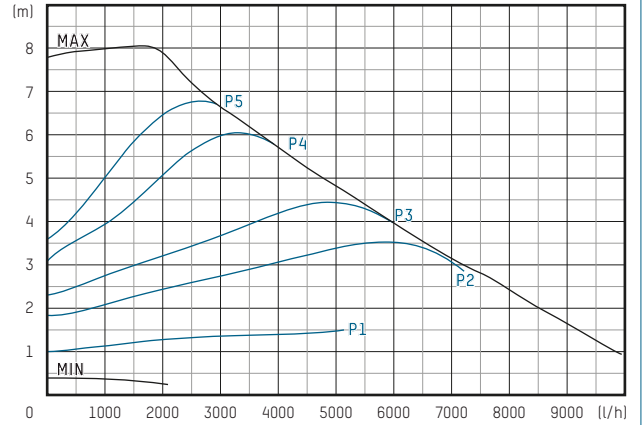

Operating mode activeADAPT – dynamic differential pressure

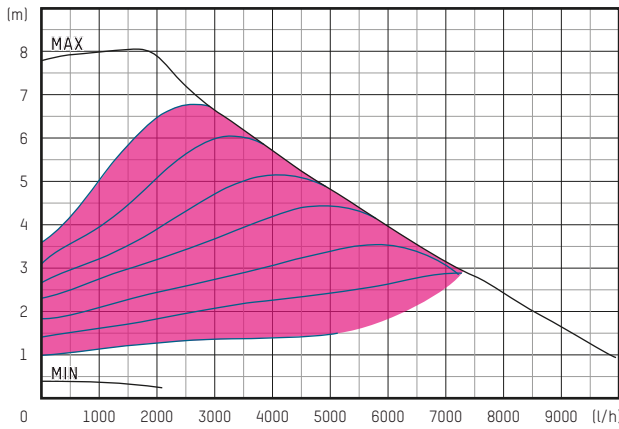

Operating mode 0 – 10 V

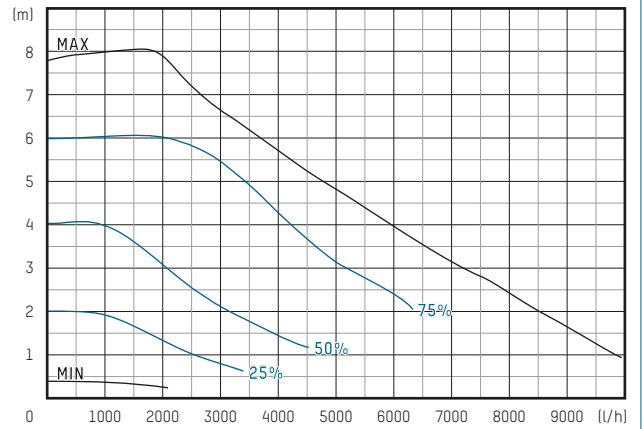

POWER CONSUMPTION CURVES

Operating mode C (Δp -c) – constant differential pressure

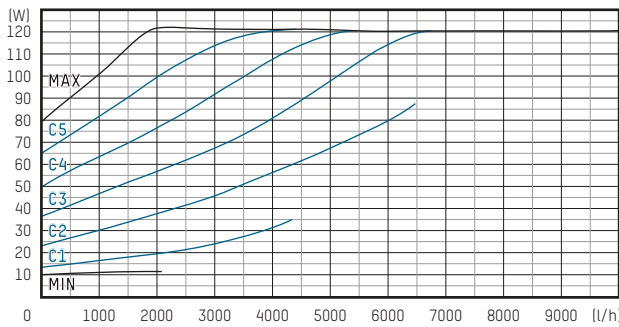

Operating mode P (Δp -v) – variable differential pressure

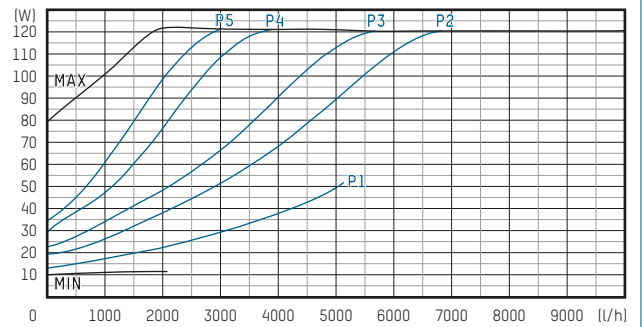

Operating mode activeADAPT – dynamic differential pressure

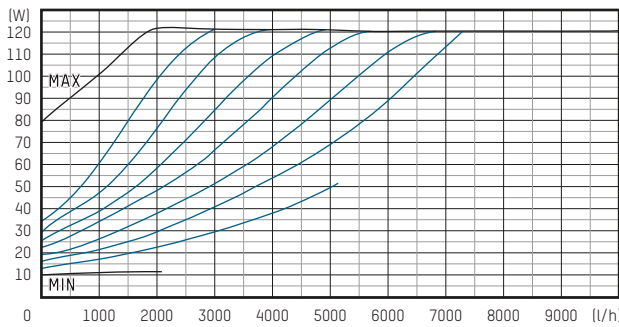

Operating mode 0 – 10 V

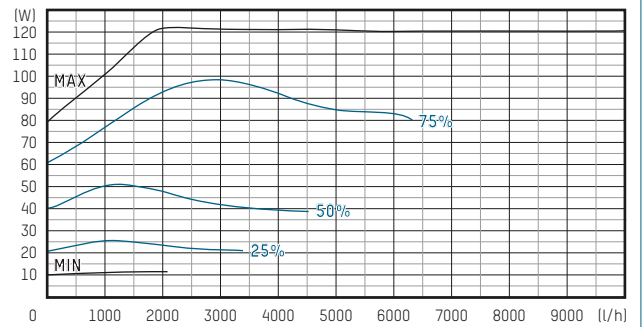

TACOFLOW3 MAX PRO | HEATING AND COOLING CIRCUIT PUMPS

SPECIFICATION TEXT

See www.taconova.com

TECHNICAL DATA

Pump

- Ambient temperature: +0 °C to +40 °C
- Permissible temperature range: -10 °C to +110 °C
- Permissible temperature ranges at max. ambient temperature:
 - at 30 °C: +30 °C to +100 °C
 - at 40 °C: +40 °C to +70 °C
- Static pressure: Max. 1.0 MPa - 10 bar
- Minimum pressure at air intake:
 - 0.05 MPa (0.5 bar) at 80 °C
 - 0.15 MPa (1.5 bar) at 95 °C
- Max. relative humidity: ≤ 80%
- Sound pressure level: < 43 dB (A)
- Low Voltage Directive (2006/95/EC): Standards applied: EN 60335-1 and EN 60335-2-51
- EMC Directive (2004/108/EC); Standards applied: EN 61000-3-2, EN 61000-3-3
- Ecodesign Directive (2009/125/EC); Standards applied: EN 16297-1 and EN 16297-2
- Inputs/outputs: PWM, 0-10 V DC

Material

- Pump body: Cast iron, CDP-coated (EN-GJL-200)
- Impeller: Brass / Composite plastic
- Shaft: Ceramic
- Bearing: Graphite / Ceramic
- Rotor housing: Composite plastic

TECHNICAL DATA (CONTINUED)

Motor and electronics

- Supply voltage: 1x230 V (±10%), PE frequency: 50/60 Hz
- Power rating (P1): Min. 16 W, max. 175 W
- Rated current (I1): Min. 0.2 A, max. 0.9 A
- Insulation class: F
- Protection rating: IP 44
- Temperature class: TF 110

TECHNICAL DATA (CONTINUED)

Fluids

- Heating water (VDI 2035; SWKI BT 102-01; ÖNORM H 5195-1)
- Water and proprietary additives used against corrosion and freezing up to 30 %

TYPE OVERVIEW

TacoFlow3 MAX PRO | Heating and cooling circuit pumps
Cast iron high efficiency pump with threaded and plug connection.
Standard thermal insulation shell.
Pump head: 10 m

Order no.	Designation	G	Centre distance	Weight
302.5269.000	MAX PRO 25-100/180	1 1/2"	180 mm	3.5 kg
302.6269.000	MAX PRO 32-100/180	2"	180 mm	3.5 kg

DIMENSIONAL DRAWING

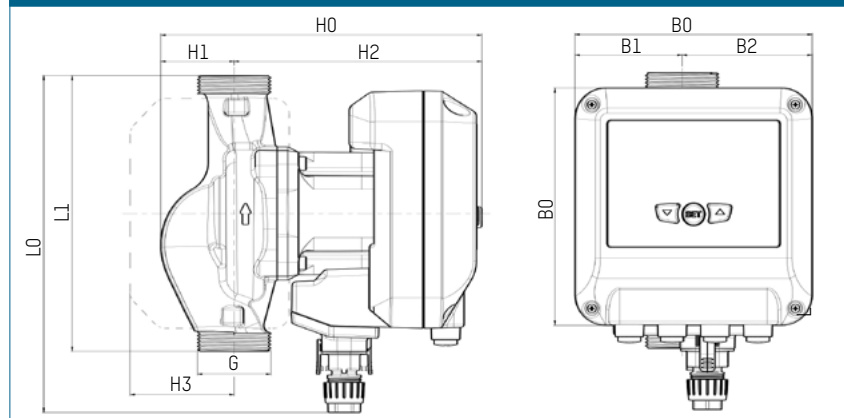

MEASUREMENT TABLE

Order no.	L0	L1	B0	B1	B2	H0	H1	H2	H3
302.5269.000	220	180	155	70	85	207	48	159	68
302.6269.000	220	180	155	70	85	207	48	159	68

ENERGY EFFICIENCY INDEX

EEI ≤ 0,22 - Part 2

Reference value for the most efficient circulation pump is EEI ≤ 0.20



küttesüsteemid • müük • paigaldus • hooldus

tel +372 442 0222 / +372 434 1000 • www.cerbos.ee • info@cerbos.ee

PERFORMANCE CURVES

Operating mode C (Δp -c) – constant differential pressure

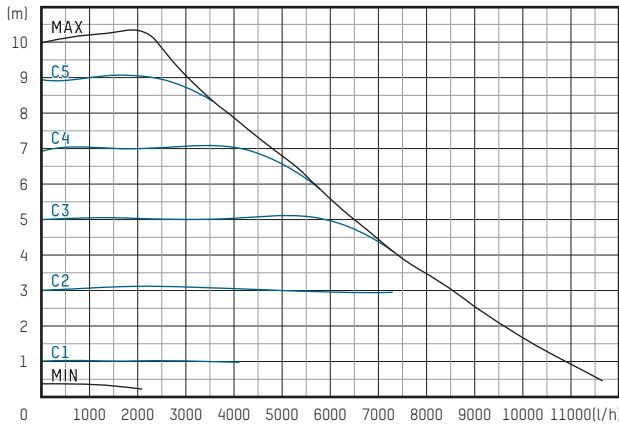

Operating mode P (Δp -v) – variable differential pressure

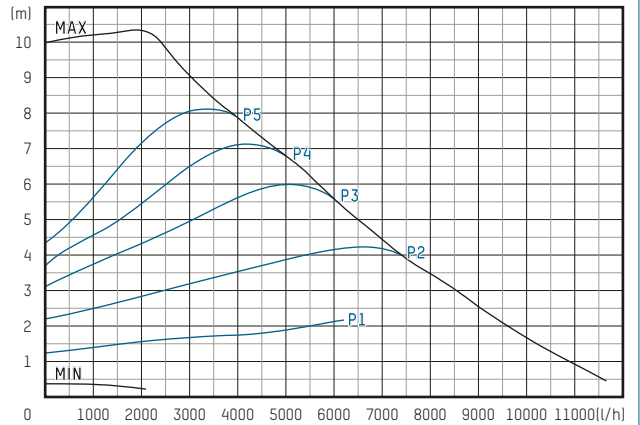

Operating mode activeADAPT – dynamic differential pressure

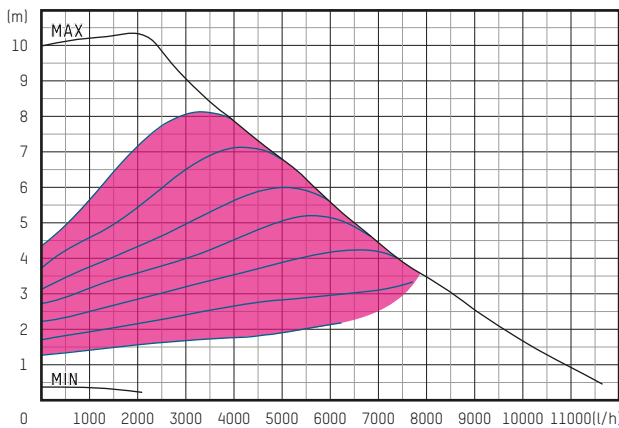

Operating mode 0 – 10 V

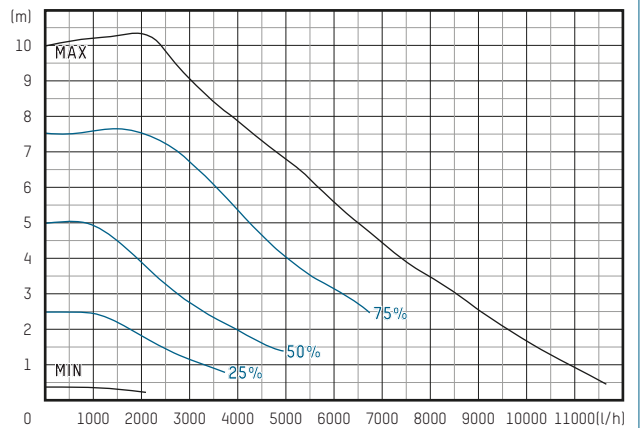

POWER CONSUMPTION CURVES

Operating mode C (Δp -c) – constant differential pressure

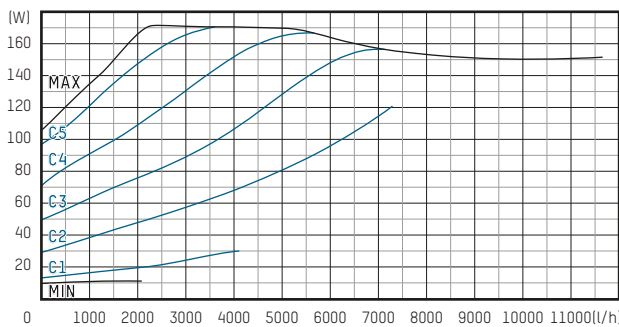

Operating mode P (Δp -v) – variable differential pressure

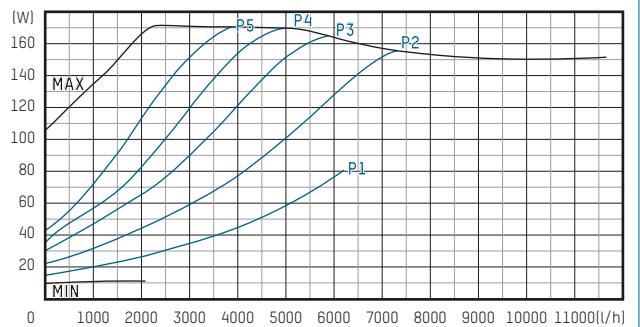

Operating mode activeADAPT – dynamic differential pressure

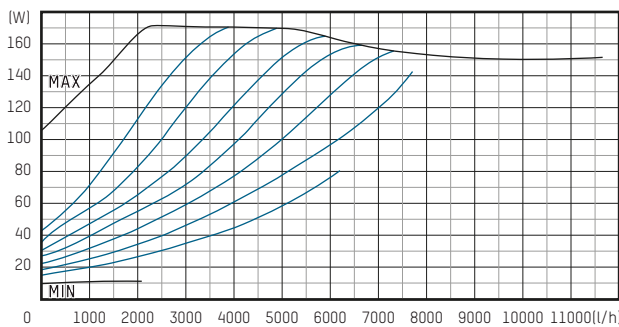

Operating mode 0 – 10 V

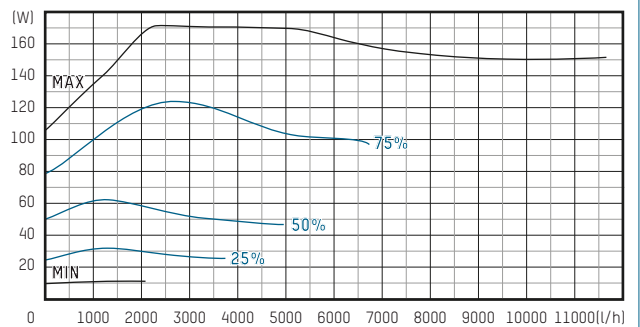

Subject to modification. 12/2019