



ROOM PANEL  
**ecoSTER TOUCH**  
FOR ECOMAX BOILER CONTROLLER



küttesüsteemid • müük • paigaldus • hooldus  
tel +372 442 0222 / +372 434 1000 • www.cerbos.ee • info@cerbos.ee



**OPERATION AND ASSEMBLY MANUAL**

ISSUE: 1.0

SOFTWARE VERSION: v01.XX.XX



# CONTENTS

1.	GENERAL INFORMATION AND SAFETY .....	4
2.	APPLICATION.....	4
3.	OPERATION .....	4
3.1	OPERATION OF THE PANEL .....	4
3.2	MAIN SCREEN .....	5
3.3	OPERATION MODES.....	5
3.3.1	Schedule.....	5
3.3.2	Economy .....	5
3.3.3	Comfort.....	5
3.3.4	Out of home.....	5
3.3.5	Airing.....	6
3.3.6	Party.....	6
3.3.7	Holidays .....	6
3.3.8	Antifreeze .....	6
3.3.9	Loading HUW .....	6
3.4	SCHEDULE .....	6
3.5	TEMPERATURE SETTINGS .....	7
3.6	BOILER.....	7
3.7	HUW.....	7
3.8	SUMMER/WINTER.....	7
3.9	BOILER ON/OFF .....	7
3.10	BOILER CONTROLLER REMOTE SCREEN .....	7
3.11	NOTIFICATIONS CONCERNING CONTROLLER ALARMS	7
3.12	SETTINGS .....	7
3.12.1	Hysteresis.....	7
3.12.2	Temperature correction .....	7
3.12.3	Screen brightness.....	8
3.12.4	Changing the language .....	8
3.12.5	PARENTAL LOCK.....	8
3.12.6	SOFTWARE UPDATE .....	8
3.12.7	SERVICE SETTINGS .....	8
3.12.8	Sound .....	8
3.12.9	Clock.....	8
3.12.10	Date.....	8
3.12.11	Panel .....	8
3.12.12	Information .....	9
4.	ASSEMBLY .....	10
4.1	TECHNICAL DATA .....	10
4.2	EXPLOITATION CONDITIONS.....	10
4.3	ASSEMBLY REQUIREMENTS.....	10
4.4	ASSEMBLY DESCRIPTION .....	10
4.5	ELECTRICAL CONNECTION WITH ECOMAX CONTROLLER MODULE .....	11
4.5.1	CONNECTION WITH ECOMAX800P1, P2, D1, D2 AND ECOMAXX800R2, T2.....	11
4.5.2	CONNECTION WITH ECOMAX800 P3, D3 AND ECOMAXX800 R3, T3 .....	12
4.5.3	CONNECTION WITH ECOMAX850P1, R1, D1 ....	12
4.5.4	CONNECTION WITH ECOMAX850P2, R2, D2 ....	13
4.5.5	CONNECTION WITH ECOMAX860P1, D1 .....	14
4.5.6	CONNECTION WITH ECOMAX860P2, D2 .....	15
5	MODIFICATIONS REGISTER .....	15

## 1. General information and safety



- Incorrect electrical connection between the room panel and ecoMAX controller may result in damage to both devices.
- Assembly has to be carried out by a qualified installer.
- Use additional precautions in order to prevent the effects of controller malfunctions and software leading to loss of property and dangerous consequences, e.g. freezing of water in the hydraulic system.
- Room panel manual is a supplement for ecoMAX controller documentation.
- User should read the manual thoroughly (we bear no responsibility for damages caused by non-observance of this manual).
- Keep this manual for future reference.

Symbols used in this manual:



Additional tips and information.



Important information, which can be crucial in terms of possible damage to property or health/life threat.

Applied standard: **WEEE 2002/96/EC (The Directive on waste electrical and electronic equipment)**.



## 2. Application

Room panel:

- mainly serves the function of programmable room thermostat
- controls the temperature inside compartments in a simple way.
- serves the function of an additional control panel for the boiler controller; displays all parameters of the boiler

controller with a touch panel or remote screen

- internal temperature sensor enables reading and programming temperature with an accuracy of 0.1°C.
- can be programmed in 7-day cycle with an accuracy of 0.5h which is equal to 48 changes of temperature during one day.
- can operate in a set of max. 3 identical room panels with a function of changing parameter settings between these panels and independent screen preview.

Room panel can be used in a household or similar environments and in slightly industrialized buildings.

## 3. Operation

### 3.1 Operation of the panel

Device is equipped with a screen and TOUCH panel.



Press corresponding symbols on the screen in order to select position from the menu.

Some of the symbols:



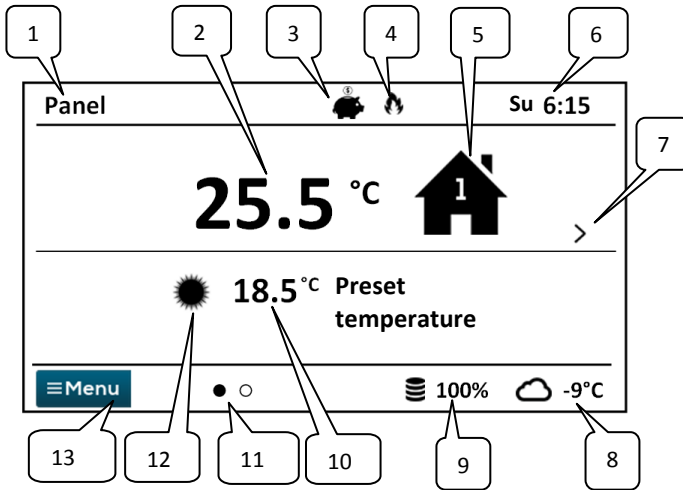

- selection of the main Menu;
- / + - decrease/increase the value of the selected parameter;
- ∨ / ^ - scroll the parameters list up/down;
- ↶ - exit a chosen Menu position or cancel a parameter setting;
- 🏠 - return back to the main screen;
- ✓ - enter the Menu position or confirm the setting of the selected parameter;
- ⓘ - Menu information concerning the selected Menu position;

### 3.2 Main screen



1. Name of the device defined by the user.
2. Current measured temperature inside the compartment.
3. Room thermostat work mode:

-  Schedule,
-  Economy,
-  Comfort,
-  Out of home,
-  Airing,
-  Party,
-  Holidays,
-  Antifreeze,
-  Loading HUW

4. Active thermostat signaling (heating).
5. Symbol of the selected device:
  -  Boiler,
  -  Room panel,
  -  Number of the panel which the current main screen is displayed for,
  -  Loading HUW.
6. Clock and weekday
7. Main screen change button.



8. Current external temperature (available only with a weather sensor connected to the boiler controller).
9. Current level of fuel inside the boiler feeder.
10. Current preset temperature inside the compartment.
11. Number of available main screens with the indication of which is currently displayed.
12. Current preset day or night temperature indicator.
13. Access to main Menu.

### 3.3 Operation modes



**Menu** → **Operation mode** → .....

#### 3.3.1 Schedule

Preset room temperature is determined in accordance with a time schedule. *Preset night temperature*  (economic) or *Preset day temperature*  (comfort) is set in the following menu: **Temperature settings** → **Night temperature/Day temperature**.  symbol is displayed on the screen.

#### 3.3.2 Economy

Controller works with a constant *Preset economic temperature*, set in the following menu: **Temperature settings** → **Night temperature**.  symbol is displayed on the screen.

#### 3.3.3 Comfort

Controller works with a constant *Preset comfort temperature*: **Temperature settings** → **Day temperature**.  symbol is displayed on the screen.

#### 3.3.4 Out of home

Existing temperature setting can be exchanged for a preprogrammed period of 1÷60h with economic temperature set in the following menu: **Temperature settings** → **Night temperature**. After this mode is activated, its duration has to be set within a range of 1÷60h, in 1h increments. After this period, the controller switches to the mode in which it has been

operating before the *Outside home* mode was set.

 symbol is displayed on the screen.

### 3.3.5 Airing

Selection of this mode will result in closing the mixing valves and switching the circulating pumps off in the boiler controller for a preprogrammed period of 1÷60min.

After this mode is activated, its duration has to be set within a range of 1÷60h, in 1h increments. After this period, the controller switches to the mode in which it has been operating before the *Airing* mode was set.

 symbol is displayed on the screen.

### 3.3.6 Party

Existing temperature setting can be changed to any temperature setting for a preprogrammed period of 1÷48h.

After this mode is activated, a required temperature and its duration has to be set within a range of 1÷60h, in 1h increments. After this period, the controller switches to the mode in which it has been operating before this mode was set.

 symbol is displayed on the screen.

### 3.3.7 Holidays

Existing temperature setting can be changed by entering one constant temperature, which will be valid for a preprogrammed period of 1÷60h. This function is useful in case of a holiday trip.

After this mode is activated, a required temperature and its duration has to be set within a range of 1÷60 days, in 1 day increments. After this period, the controller switches to the mode in which it has been operating before this mode was set.

Activation of this mode will additionally result in setting a preset temperature of hot utility water on the ecoMAX boiler controller to 8°C.

 symbol is displayed on the screen.

### 3.3.8 Antifreeze

Controller works with a constant preset temperature set in the following menu:

**Temperature settings** → **Antifreeze temperature**

Activation of this mode will additionally result in setting a preset temperature of hot utility water on the ecoMAX boiler controller to 8°C

 symbol is displayed on the screen.

### 3.3.9 Loading HUW

This mode enables loading the HUW tank once.

After this mode is activated, its duration has to be set within a range of 1÷60h, in 1h increments. During the period in which this mode is active, night temperature decreases set in schedules for the HUW tank and circulation pump are inactive.

## 3.4 Schedule



Menu enables programming time schedules for room thermostats, hot utility water tank and operation of HUW circulating pump. It is possible to set time schedules for every weekday separately with an accuracy of 0.5h (48 changes of temperature during one day). The controller enables setting two temperature levels: day (comfort) and night (economic).

Schedules can be edited in:

**Menu** → **Schedule** → ...

- Select a weekday for which the schedule will be set / modified.
- Schedule edition window will be displayed.

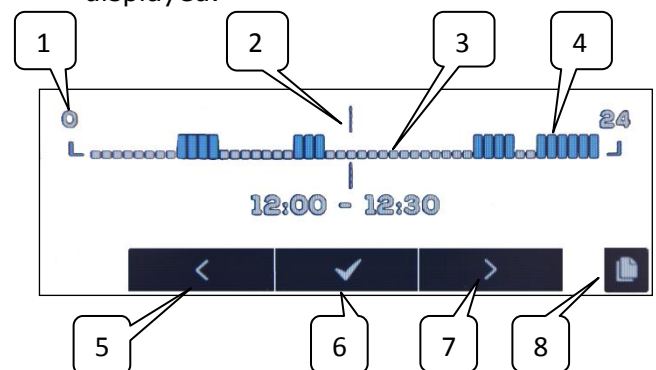

1-time period line, 2-currently edited time period, 3 - night temp., 4 - day temp, 5,7-time period selection, 6-temp. selection., 8-entering schedules copying menu.

In order to set the required time period:

- Set the indicator "2" to a starting hour of time zone with the use of < , > buttons,

- Set the comfort (day) or economic (night) temperature with the use of ✓ button.
- Set the indicator "2" to an ending hour of time zone with the use of < , > buttons,
- Press ✓ button in order to finish editing the zone,
- The aforementioned actions can be repeated for other time period, if required
- Press  button in order to display window for copying the set schedule to any weekday.

### 3.5 Temperature settings



Enables changing *preset temperatures* inside the compartment:

- *Day temperature (comfort),*
- *Night temperature (economic),*
- *Anti-freeze temperature.*

### 3.6 Boiler



*Boiler* – enables remote access to boiler controller menu which the room panel is connected to. It is possible to preview and edit all parameters and alarms available in the ecoMAX boiler controller.

### 3.7 HUW



*HUW* - enables setting a preset temperature and work mode of the hot utility water tank.

### 3.8 Summer/Winter



*Summer/Winter* - enables changing the "Summer/Winter" work mode in the boiler controller.

### 3.9 Boiler on/off



*Boiler on/off* – enables remote activation or deactivation of the boiler controller from the room thermostat.

Menu positions: *Boiler, HUW, Summer/Winter* and *Boiler on/off* are optional and available only in case of connecting the ecoSTER TOUCH panel to the controller with compatible software.



### 3.10 Boiler controller remote screen

If the boiler controller is equipped with a standard control panel (version with a knob), the ecoSTER TOUCH room panel will display a precise graphic image of the controller main screen (remote screen) on one of the main screens. Menu position is selected by pressing < | ✓ | > symbols on the screen. For safety reasons, not all controller menu positions will be available.

### 3.11 Notifications concerning controller alarms

Room panel displays the alarms transmitted by the boiler controller and reports them using a sound signal. Touch the screen in order to turn off the active alarm. The alarm will not be deleted. For safety reasons, this can be done only via the boiler controller.

### 3.12 Settings



**Menu** → **Settings** → .....

#### 3.12.1 Hysteresis



This parameter defines temperature hysteresis inside the compartment. Boiler controller will begin heating when temperature inside the compartment drops below the current preset temperature minus hysteresis. Heating will end up when the current preset temperature inside the compartment is reached.

#### 3.12.2 Temperature correction



Enables entering a correction of thermostat measured temperature within a range of -4.0°C to +4.0°C.

### 3.12.3 Screen brightness



Enables setting screen backlight brightness in [%] separately for a day (6:00-22:00), night (22:00-6:00) and the current edition of settings.

### 3.12.4 Changing the language



Enables changing the language of the room thermostat.

### 3.12.5 Parental lock



This function activates itself after few minutes of inactivity.  symbol is then displayed on the screen next to the clock. Touch and hold the screen for a few seconds in order to unlock the panel.

### 3.12.6 Software update



Enables updating the software with the use of a microSD memory card (inserted into a slot in the panel enclosure) in all connected devices: boiler controller, additional modules, control panels and room panels.

### 3.12.7 Service settings



You must enter service password in order to enter the settings.

- *Hotel mode* – disables editing other room thermostats and access to this device menu. User can execute only basic settings.
- *Visibility in other panels* – enabling options of preview and edition of this device from other room thermostats.
- *Restore default settings* – returning to default settings.
- *Touch panel calibration* – enables calibrating the touch panel.

### 3.12.8 Sound



Activation/deactivation of sound in alarms and notifications sent by the boiler controller.

### 3.12.9 Clock



Setting the current time. Panel has a function of time synchronization with other room thermostats and boiler controller.



Time synchronization will take place when time difference between thermostats/controller exceeds 10s.

Time change from the level of one room panel will result in a time change in remaining panels and boiler controller itself. The panel connected to a power source receives time setting from the boiler controller.



Programmed schedule operates on the basis of internal memory of the room panel and is not deleted in absence of power supply.

### 3.12.10 Date



Setting the current date. After the date is set, day of the week will be set automatically. Synchronization function is also applied here and it works similarly as in case of changing time settings.

### 3.12.11 Panel



Enables assigning an individual address and name to the panel.

- *Panel address* – User can select addresses 1, 2 or 3. This parameter enables changing address of the room panel. If several room panels are connected to one boiler controller.



In order for the system to operate correctly, particular room panels must be assigned different addresses.

- *Name* – user can enter their own name of the room panel, e.g. attic, living room,



etc. It facilitates determining location of the panel inside the building and changing preset temperature in a distant room. This name will be additionally visible on screens of other room panels.

Selected panel *Address* (at 2 or 3 connected panels) is displayed on the main screen as



(further digits 2,3). *Name* is displayed (also for other panels) in the upper bar of the screen (on the left).

### **3.12.12 Information**



Information concerning software versions used in the boiler controller panels and additional modules.



It is recommended to use the same software version for all connected room thermostats.

## 4. ASSEMBLY

### 4.1 Technical data

Power supply/consumed current	+12VDC/150mA
Protection class	IP20
Work/storage temperature	0..50/0..65 °C
Temperature measurement/regulation range	0..50/5..35 °C
Hysteresis	0.2..5 °C
Relative humidity	5 - 85%, without condensation
Display	graphic, touch
Dimensions	148x97x23 mm
Weight	0.2 kg
Standards	PN-EN 60730-2-9 PN-EN 60730-1
Software class	A

### 4.2 Exploitation conditions

- do not expose the device to direct influence of atmospheric conditions (rain, sunlight) nor vibrations stronger than typical occurring during wheel transportation.
- do not use the device in vapor condensation conditions and protect it from water.
- storage and transportation temperature should not exceed the range of -15...65 °C.
- install the device only in dry residential room.

### 4.3 Assembly requirements

Recommendations:

- Panel is intended for wall installation inside compartments.
- Assemble the panel at a height of approx. 1.5 m above the floor.
- Avoid highly insulated areas with poor air circulation, near heating devices and in direct vicinity of doors and windows – temperature measurement is disturbed by external conditions.
- Panel should be installed by a qualified installer.

Manufacturer bears no responsibility for damages caused by non-observance of this manual.

### 4.4 Assembly description

- Drill holes in the wall (apply rawplugs in case of masonry wall) and screw the screws in. Distance between holes is given on the back side of the room panel (90x43mm).
- Execute electrical connection between the panel/panels and the boiler controller serving as its power source with the use of electrical wire.
- Wire can be flush or wall mounted.
- Do not lead the connection wire along with wires of electrical network in the building. Wire cannot be located near devices emitting strong electromagnetic field.

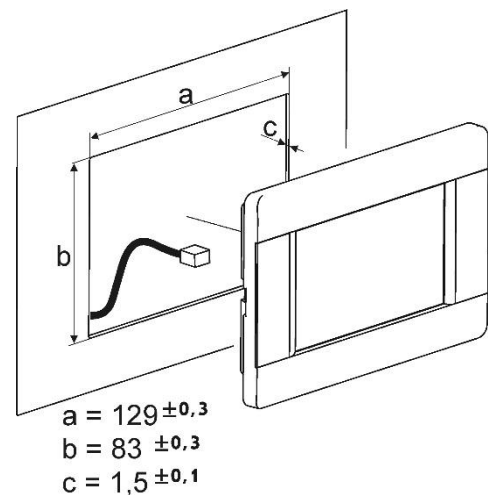



#### 4.5 Electrical connection with ecoMAX controller module

Recommended supply voltage of the room panel is **+12VDC**.

 Panel can be supplied with +5÷12V. However, it is not recommended due to voltage losses in long connection wires.

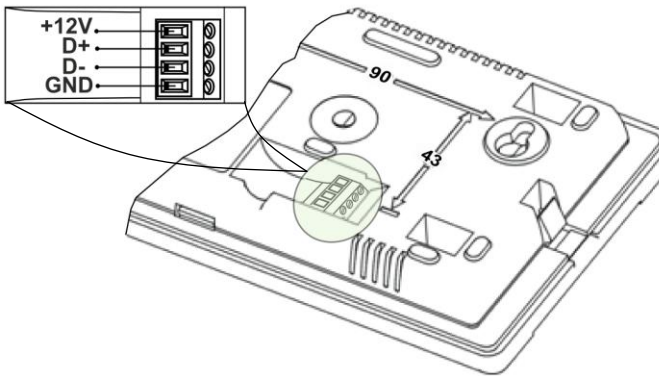
4-wire cable with a max. length of **30m** and cross-section of  $\geq 0.5 \text{ mm}^2$  is required to connect to the controller module terminals. Terminal signal outputs in the rear side of the panel:



 Be careful to connect the poles correctly. Incorrect connection may cause damage to devices.

 Depending on the type of ecoMAX controller, room panel can be supplied directly from the boiler controller module terminals. If not, use an additional power adaptor **+12VDC, I $\geq$ 0.5A**.

 Depending on the ecoMAX boiler controller software version, it can cooperate with only one or max. three ecoSTER TOUCH room panels.

Further chapters describe the method of connecting the ecoSTER TOUCH room panel/panels to various ecoMAX series boiler controller modules.

#### 4.5.1 Connection with ecoMAX800P1, P2, D1, D2 and ecoMAXX800R2, T2

All 1,2,3 room panels require application of an additional power adaptor **+12VDC, I $\geq$ 0.5A**.

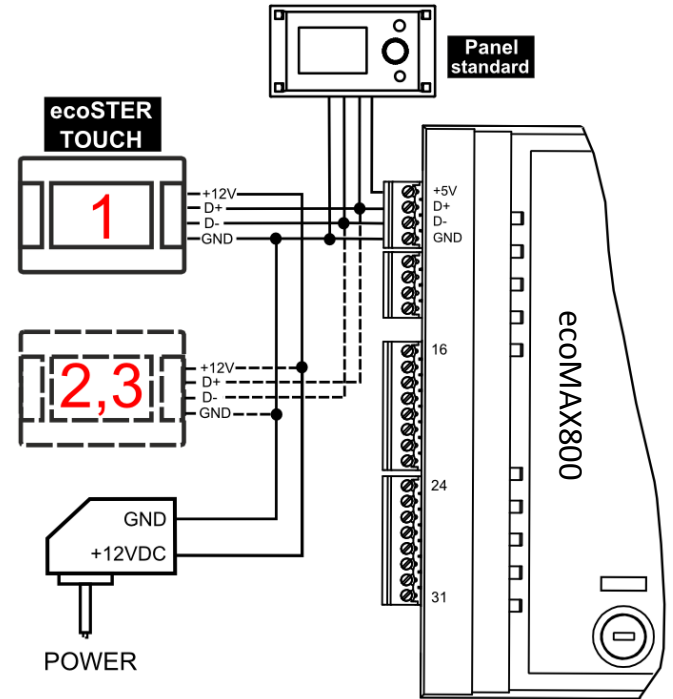

#### 4.5.2 Connection with ecoMAX800 P3, D3 and ecoMAXX800 R3, T3

 Controller module can supply up to 2 colored TOUCH type panels simultaneously.

If the boiler controller is equipped with a standard control panel (version with a knob), two ecoSTER TOUCH room panels can be supplied directly from the controller module (**terminal 31**). Third panel has to be supplied by the additional power adapter **+12V, I $\geq$ 0.5A**.

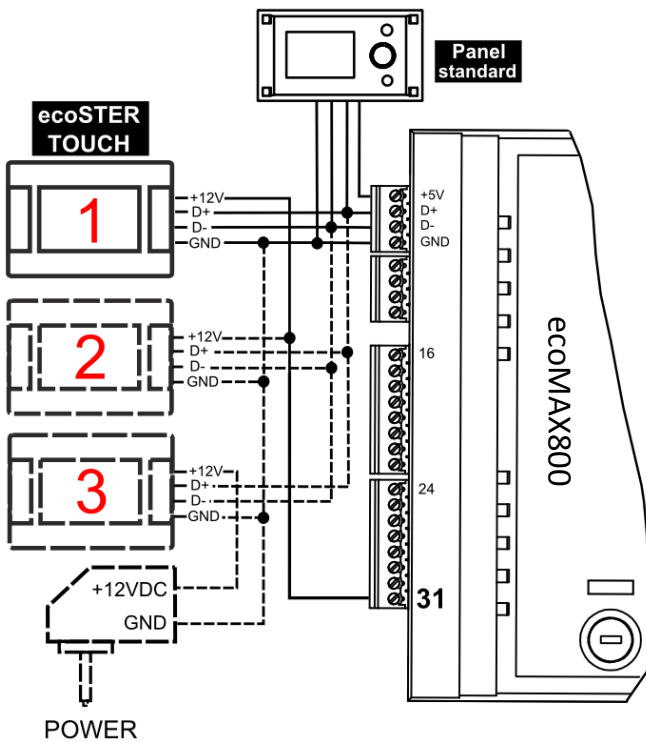

If the boiler controller is equipped with ecoTOUCH control panel (colored with a touch panel), only one ecoSTER TOUCH room panel can be supplied directly from the controller module (**terminal 31**). Panels 2 and 3 have to be supplied by the additional power adapter **+12V, I $\geq$ 0.5A**.

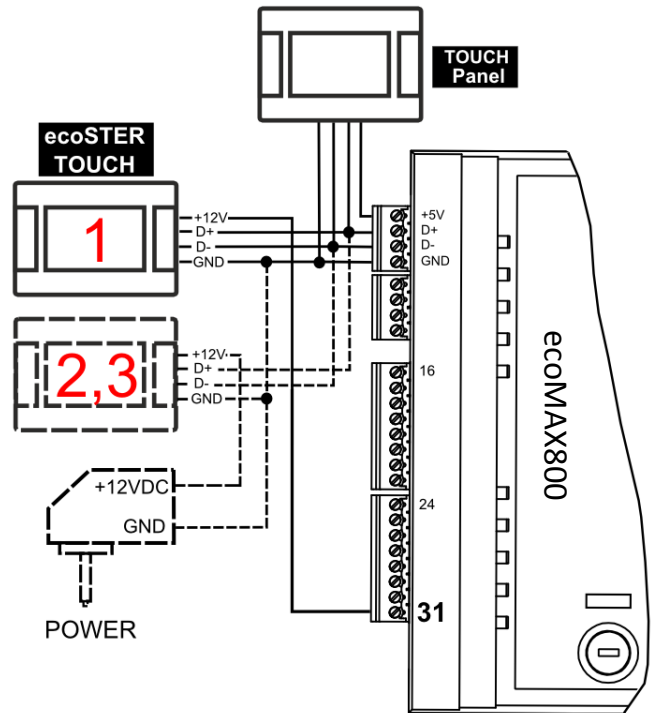

#### 4.5.3 Connection with ecoMAX850P1, R1, D1

All 1,2,3 room panels require application of an additional power adapter **+12VDC, I $\geq$ 0.5A**.

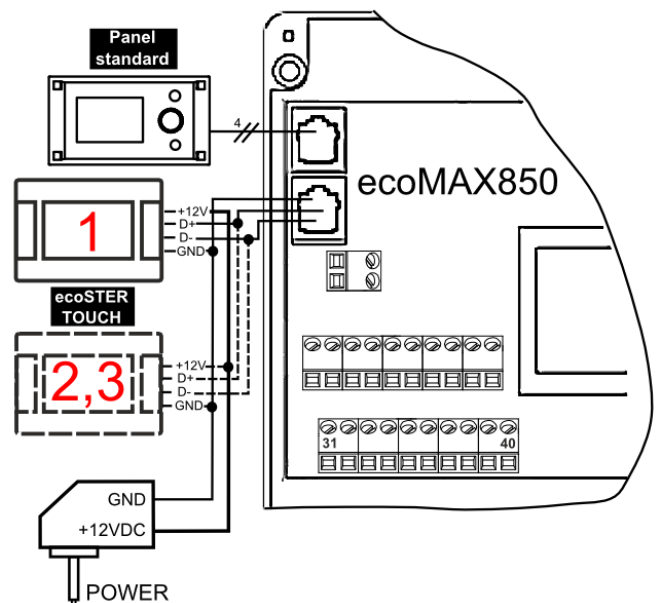

#### 4.5.4 Connection with ecoMAX850P2, R2, D2

 Controller module can supply up to 2 colored TOUCH type panels simultaneously

If the boiler controller is equipped with a standard control panel (version with a knob), two ecoSTER TOUCH room panels can be supplied directly from the controller module (**terminal 40**). Third panel has to be supplied by the additional power adapter **+12V, I $\geq$ 0.5A**.

If the boiler controller is equipped with ecoTOUCH control panel (colored with a touch panel), only one ecoSTER TOUCH room panel can be supplied directly from the controller module (**terminal 40**). Panels 2 and 3 have to be supplied by the additional power adapter **+12V, I $\geq$ 0.5A**.

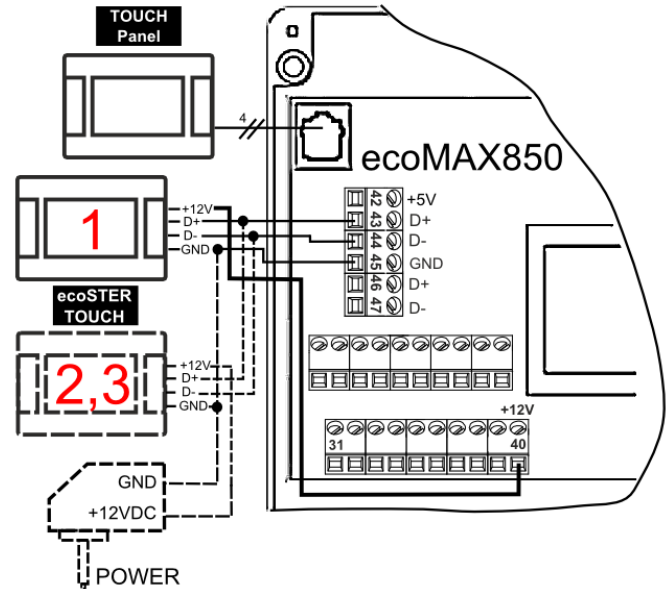
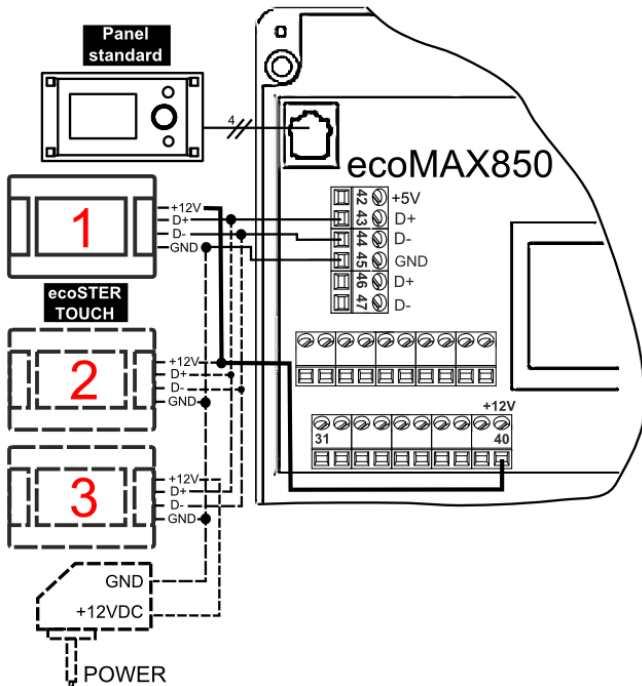

#### 4.5.5 Connection with ecoMAX860P1, D1



Controller module can supply up to 2 colored TOUCH type panels simultaneously.

If the boiler controller is equipped with a standard control panel (version with a knob), two ecoSTER TOUCH room panels can be supplied directly from the controller module (**terminal 46**). Third panel has to be supplied by the additional power adapter **+12V, I≥0.5A**.

If the boiler controller is equipped with ecoTOUCH control panel (colored with a touch panel), only one ecoSTER TOUCH room panel can be supplied directly from the controller module (**terminal 46**). Panels 2 and 3 have to be supplied by the additional power adapter **+12V, I≥0.5A**.

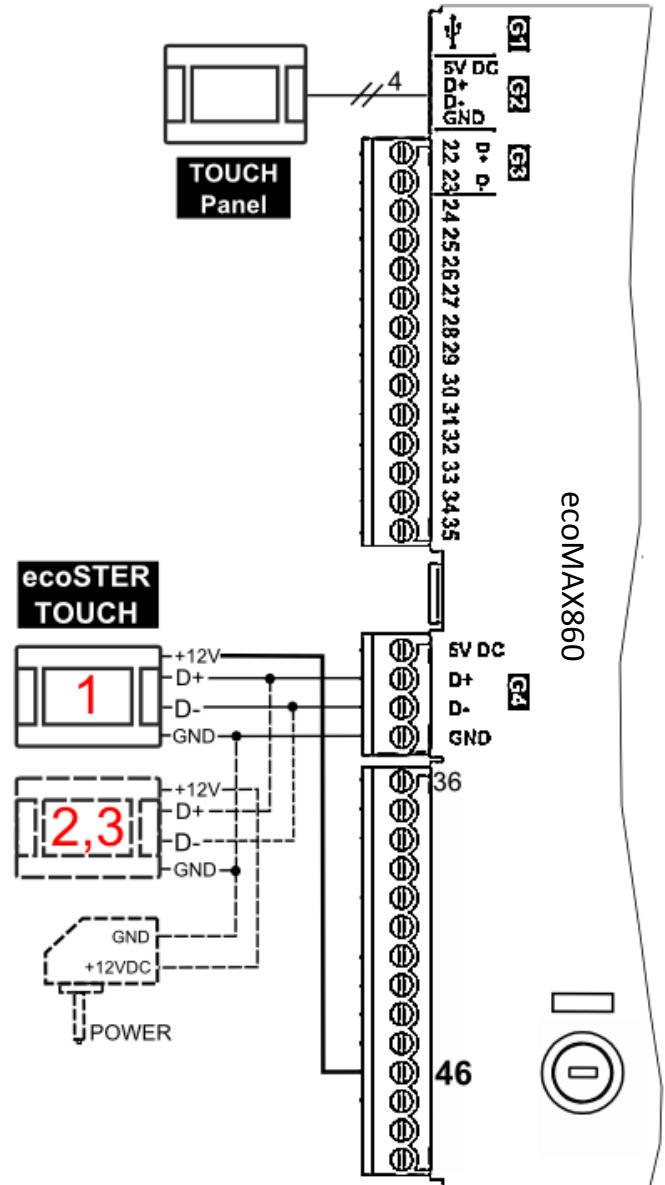
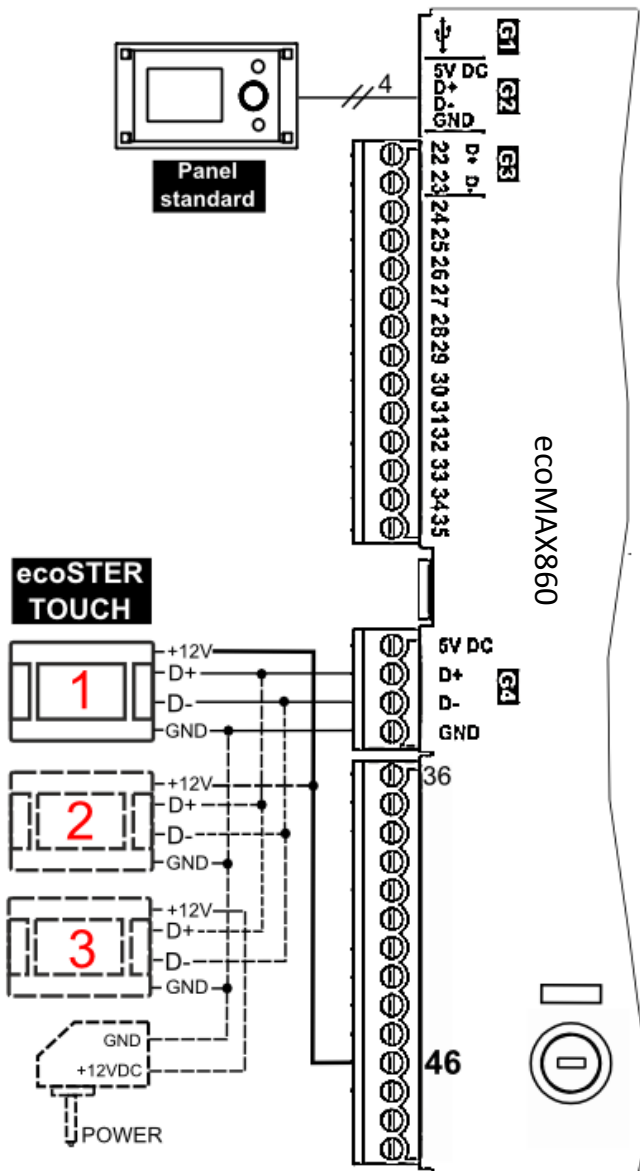

#### 4.5.6 Connection with ecoMAX860P2, D2

 Controller module can supply up to 2 colored TOUCH type panels simultaneously.

If the boiler controller is equipped with a standard control panel (version with a knob), two ecoSTER TOUCH room panels can be supplied directly from the controller module (**socket G4**). Third panel has to be supplied by the additional power adapter **+12V, I≥0.5A**.

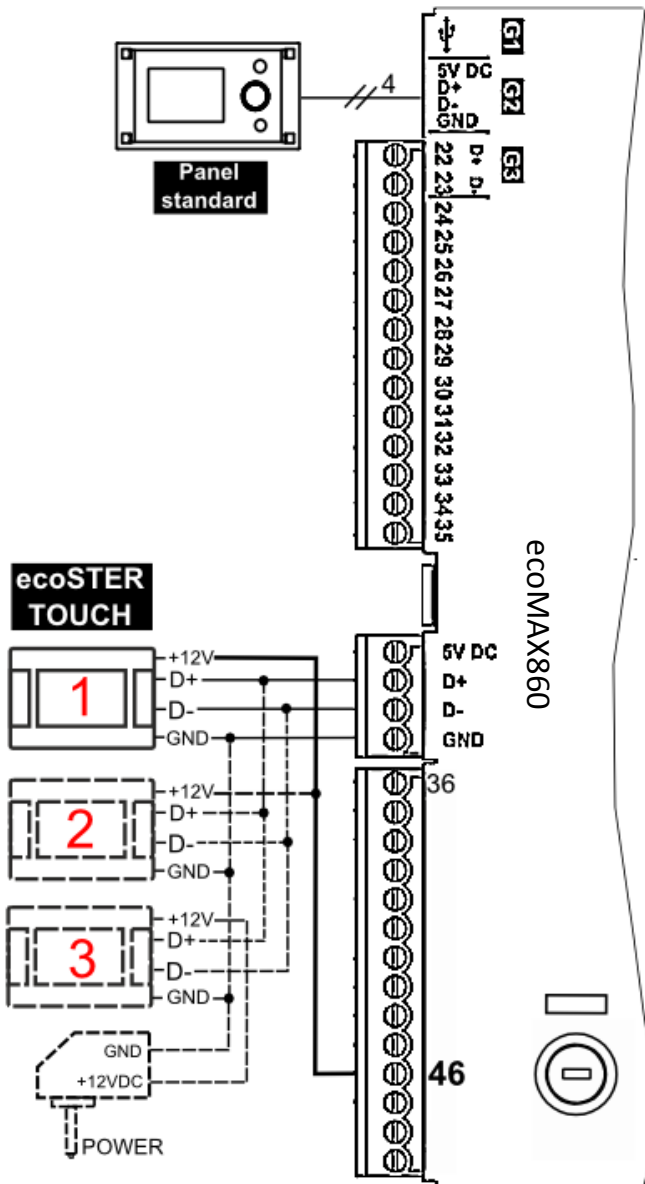

If the boiler controller is equipped with ecoTOUCH control panel (colored with a touch panel), only one ecoSTER TOUCH room panel can be supplied directly from the controller module (**socket G4**). Panels 2 and 3 have to be supplied by the additional power adapter **+12V, I≥0.5A**.

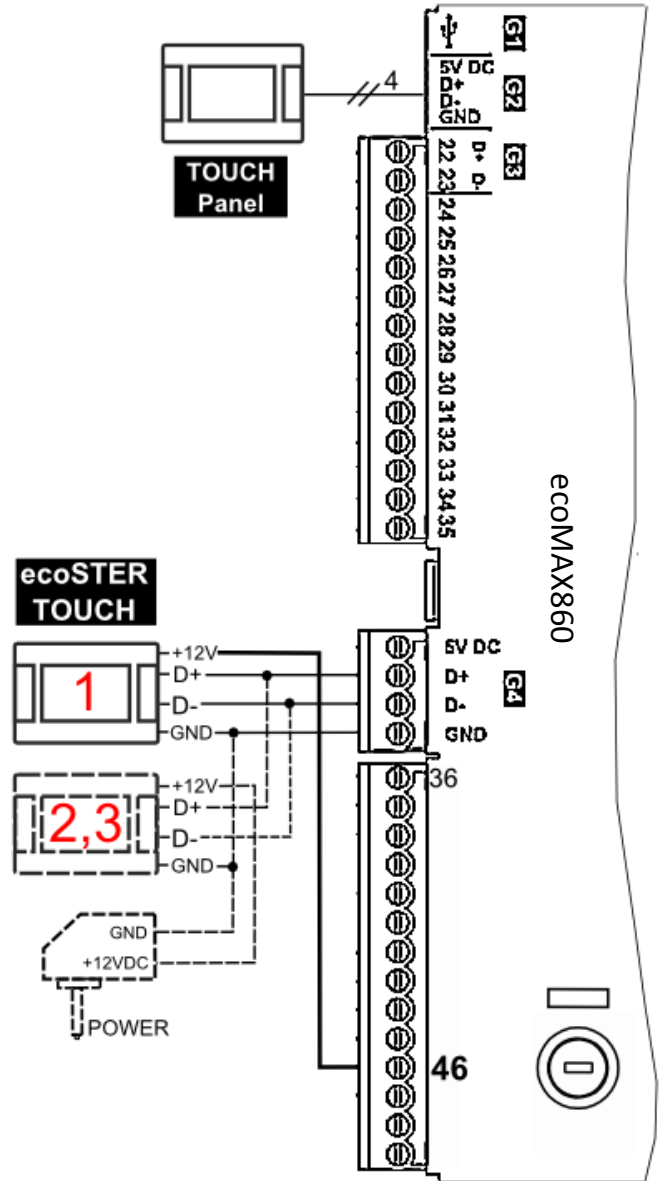

**5 Modifications register**













 **Cerbos**  
küttesüsteemid • müük • paigaldus • hooldus  
tel +372 442 0222 / +372 434 1000 • www.cerbos.ee • info@cerbos.ee



**ul. Wspólna 19, Ignatki  
16-001 Kleosin  
Poland  
phone +48 85 749-70-00  
fax +48 85 749-70-14  
plum@plum.pl  
www.plum.pl  
www.plumelectronics.eu**