

SmartSol

LK 150 Top



Cerbo

küttesüsteemid • müük • paigaldus • hooldus
tel 442 0222 / 434 1000 • www.cerbo.ee • info@cerbo.ee

INSTRUCTION MANUAL



LK Armatur

These Assembly and Operating Instructions are an integral part of the product.

- > Read Assembly and Operating Instructions carefully before using the product.
- > Keep them in a safe place during the product's service life.

Translation from the German original edition ©emz 2015 - Subject to modifications.

The contents and representations of these Assembly and Operating Instructions are the intellectual property of emz-Hanauer GmbH & Co.KGaA.

Non-authorized disclosure, reproduction, divulgation or editing of this documentation, as well as exploitation, utilization or publication, are prohibited.

The rights to the word and design marks ›emz - smart solutions‹ and ›smart Sol‹ are the exclusive property of emz-Hanauer GmbH & Co.KGaA.

The rights to any cited brands, names or logos are the property of their appropriate developers / of the licensees in question.

Table of contents	Page
Important fundamental information	4
Symbols used	5
Description	6
Dimensions	7
Technical Data	8
Designation of the components	10
Operation of the controller	11
Display	12
Opening the terminal cover	13
Wall-mounting	14
Connection to power supply	15
Data interfaces	19
Hydraulic systems	20
Functions for boiler control	45
Thermostat functions	48
Commissioning mode	49
Automatic mode	66
Operation mode	68
Malfunction	84
Replacement of fuse	90
Professional mode	91
Disassembly/Disposal	114
Warranty and liability	115
Commissioning report	116
Service request	117
EC Declaration of conformity	118
Index	119

IMPORTANT FUNDAMENTAL INFORMATION

These instructions describe installation, commissioning, operation, repair and disassembly of the differential temperature controller **smart Sol** for solar thermal plants.

For operation of the entire plant, the technical documentation of all the components used such as solar collectors, boiler, tank, pumps, mixers and valves etc. must be complied with.



Danger!

Assembly, connection, commissioning, repair and disassembly of the controller may only be performed by a qualified specialist!



The controller is handled by the operator of the entire solar thermal plant, i. e. as a rule by technical non-experts.



Danger!

The controller by no means replaces the safety components required under plant engineering aspects!



Make sure not to use the controller until you have thoroughly read and understood these Assembly and Operating Instructions and the safety provisions. Comply with all safety provisions and involve a specialist in case of doubt.



Important!

The fitter installing the controller must inform the plant operator about operation, functioning and the method of action of the **smart Sol**!



Keep these Assembly and Operating Instructions and all reference documents so that they are available if required.

When relocating or when selling the device, hand the documents over to your successor.



Danger!

The device in operation may only be made accessible to adults disposing of appropriate knowledge and experience!



When handling the differential temperature controller **smart Sol** and the entire plant, please make sure that the following safety provisions in the Assembly and Operating Instructions are complied with!

**Danger!**

Immediate danger for assets, life and limb!

**Important!**

Important information compliance with which is essential!

**Note!**

Useful information regarding handling of the device and the plant!



DESCRIPTION

The differential temperature controller **smart Sol** is an independent electronic controller for surface-mounting which is used for the control of solar thermal plants.

The controller is equipped with a robust three-part plastic housing which can only be opened by means of tools (screw driver PH2).

Operation is effected by means of only two control elements; indications appear against a backlit colour display.

Before connection of the electrical system, the controller must be mounted firmly to a perpendicular, robust surface (wall).

For its own supply and the supply of the outputs, the controller must be connected to an electrical energy supply system in accordance with the technical data.



Note!

The electrical equipment of the device must be installed firmly and connected to the power supply via a disconnecter ensuring complete isolation from the power supply according to the erection regulations!



Assembly, connection, commissioning, repair and disassembly of the controller are only admissible in a specialist workshop.

To ensure correct operation, temperature sensors type Pt 1000 must be used - the sensor design does not affect function.

Each temperature sensor has two connectors which are equivalent, i. e. interchangeable. Thus, polarity reversal is not an issue.

The sensor lines can be extended up to a length of 100 m, to this effect, a cable cross section of $2 \times 1.5 \text{ mm}^2$ is recommended.



Important!

Make sure that only a dry or slightly moistened cloth is used for cleaning and servicing of the housing, the control elements and the display.

The surfaces must never get into contact with cleaning products or solvents - mat, brittle or slightly dissolved plastic parts must be replaced immediately!

A device with damaged housing must not be operated!



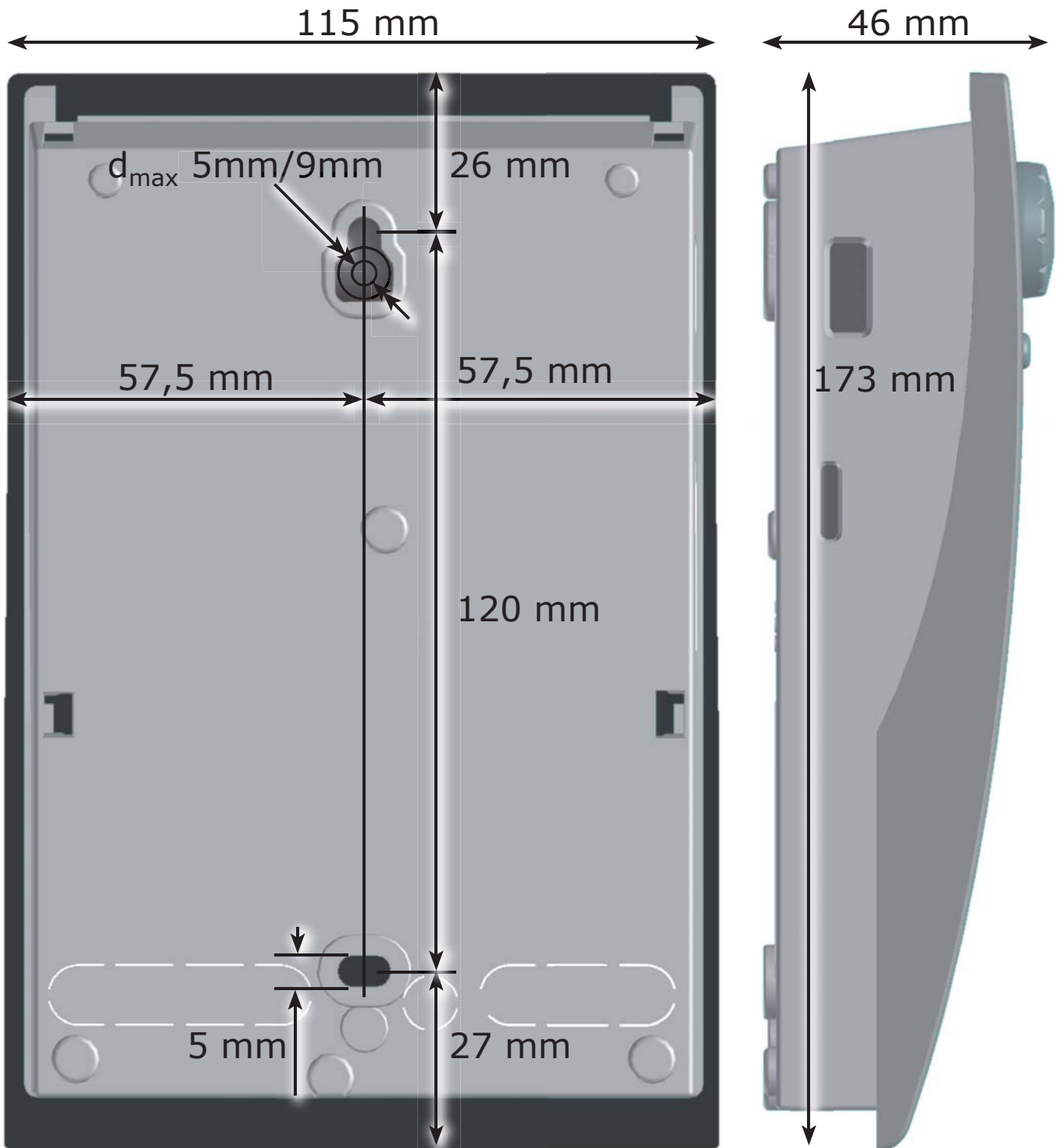

Intended Use

The differential temperature controller may be used exclusively as controller for the control of solar thermal plants. It must be operated within the scope of all the specifications described. Installation and set-up of the controller may only be performed by specialists. The fitter must have read and understood the operating manual. The fitter explains all the relevant functions to the operator. For operation, it is essential that the housing is closed and free of damage.

Scope of supplies

- 1 Differential temperature controller **smart Sol**
- 1 Instruction manual

Differential temperature controller smart Sol

Type of mounting	Wall-mounting
Housing	Plastics, in several parts
Mode of operation	Type 1
Type of protection	IP 20
Dimensions Width x Height x Depth [mm]	115 x 173 x 46
Weight [g] Basic version	370
Storage/operating temperature [°C]	0-40, non-condensation
Handling	via rotary encoder and pushbuttons
Display	TFT colour display 47 x 35 mm, backlit
Power reserve of real time clock, at least [h]	8

Connection to power supply

Design	3 spring-type terminals PE, N and L
Service voltage [VAC]	230 ±10%
Line frequency [Hz]	50 ±1%
Auxiliary consumption typ. [W]	1,74
Power consumption max. [W]	3.5
Fuse	Micro fuse, type 5 x 20 mm, T2A/250 V
Rated pulse voltage [V]	2500

Max. cross sections to be connected

Cable end sleeve:	0.25 to 0.75 mm ²
Single-wire	0.50 to 1.50 mm ²
Fine-wired	0.75 to 1.50 mm ²

Interfaces TS1 / TS2 / TS3 / TS4 / TS5 / TS6

Design	2 spring-type terminals each
Assignment as inputs	
Admissible temperature probe	Temperature sensor Pt 1000
Optional assignment of TS3 / TS4 to the impeller sensor	DFZ 1-100 pulses/litre
Optional assignment as output on TS4	PWM signal 100Hz...2kHz or analogue output 0...10V, max. 10mA

Interface TS7 / TS8

Design	2 spring-type terminals each
Assignment as output	PWM signal 100Hz...2kHz analogue output 0...10V, max. 10mA

Triac outputs RO1 / RO2

Design	3 spring-type terminals each, PE, N and L
Output voltage [VAC]	230 ±10%
Output power max. per output [VA]	200
Output current max. per output [A]	1

Switching output REL: change-over contact

Design	3 spring-type terminals
Switching voltage max. [V]	253
Switching capacity max. [VA]	230
Switching current max. [A]	1

Interface for analogue Vortex flow sensors

Design	Plug connector
--------	----------------

DESIGNATION OF THE COMPONENTS

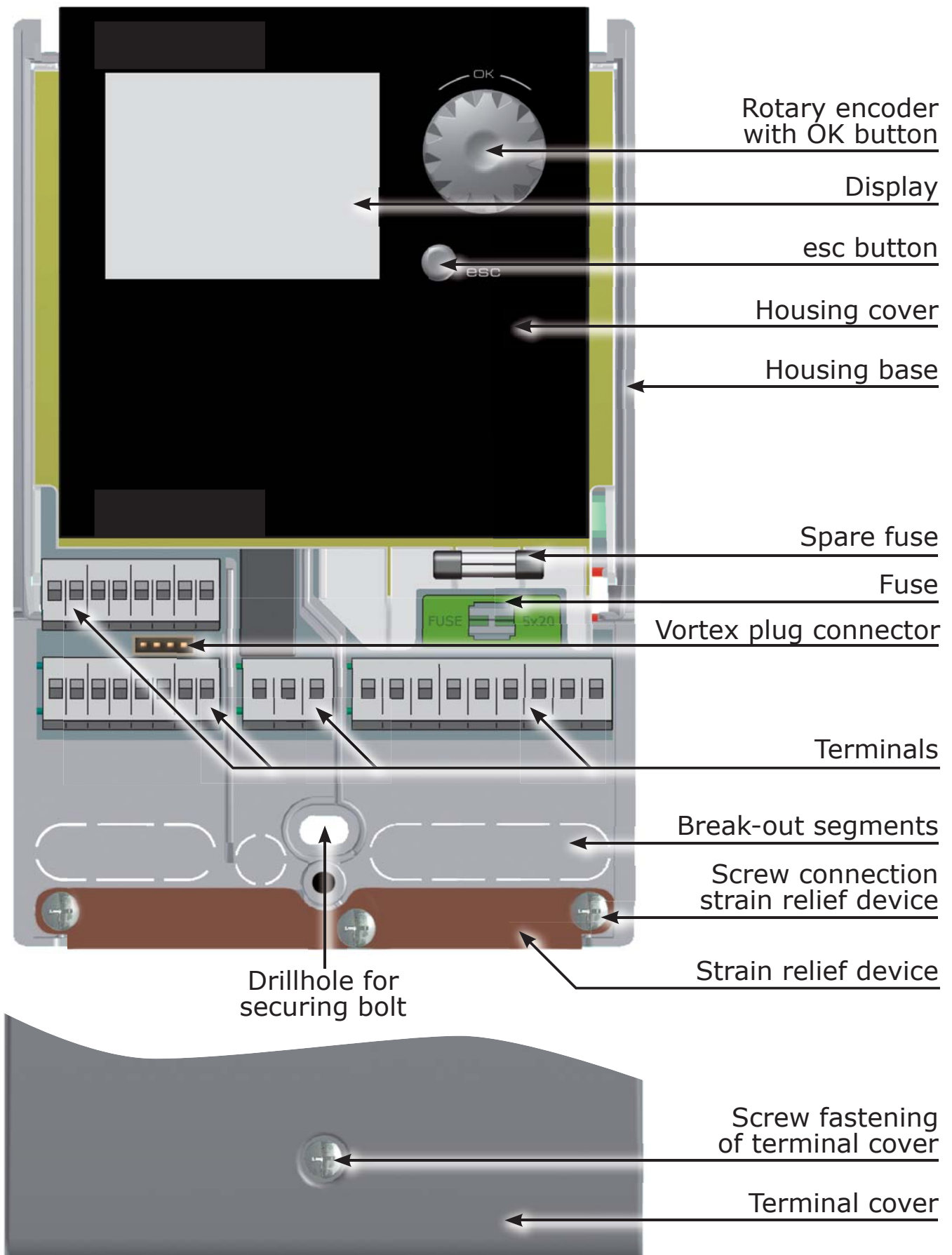

The entire set-up and operation of the differential temperature controller **smart Sol** is effected via only two control elements on the device front.

All settings and interrogations are effected via the rotary encoder.

To find a required menu item, turn the rotary encoder to >scroll< through the menu - the selectable option appears on a coloured background on the display.

To confirm the selected menu item, press the rotary encoder. An appropriate submenu is called up, or selection is activated.

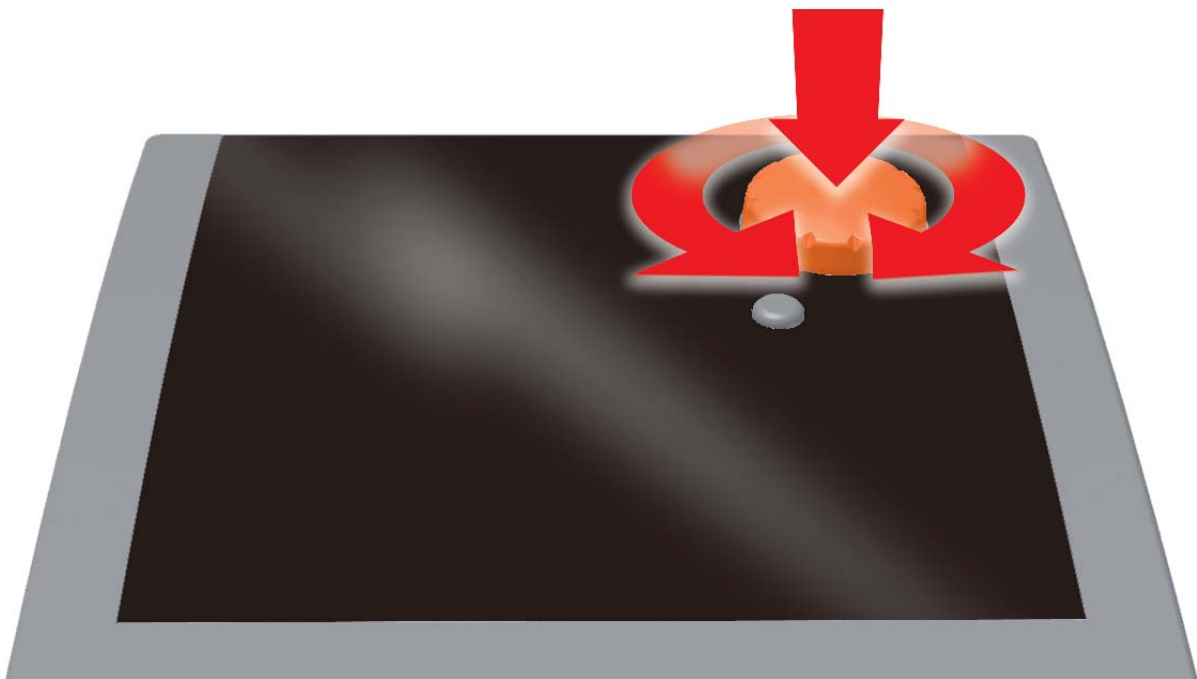

Press the esc button to make the menu return by one level from any subitem.

If no input is made within the preset time (30-255 s), the controller returns automatically to the initial level.

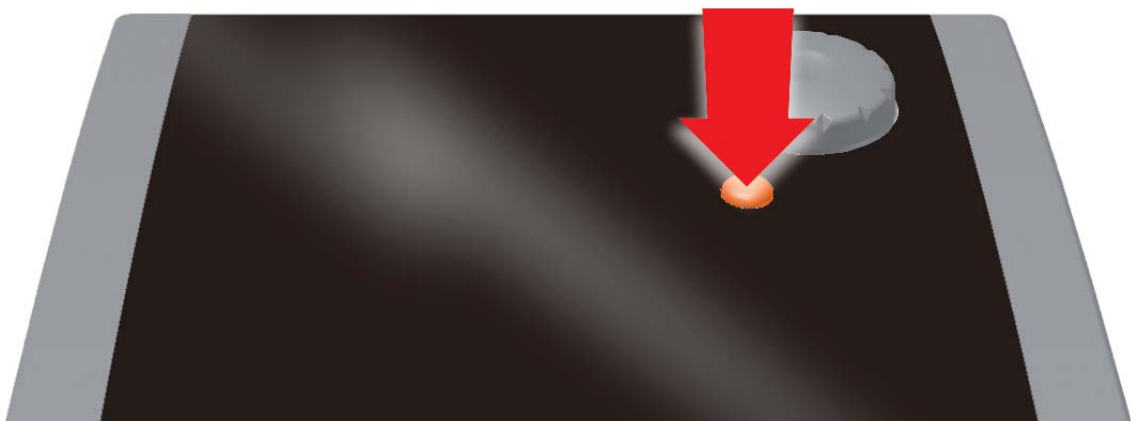

For indication of the operating mode and for communication in case of set-up, malfunction, modification and evaluation, the differential temperature controller **smart Sol** is equipped with a coloured full graphics display which is permanently backlit.

The display is active as long as there is supply voltage on the controller.

After a preset time (30 - 255 s), backlighting is dimmed to 10%.

Schema 1

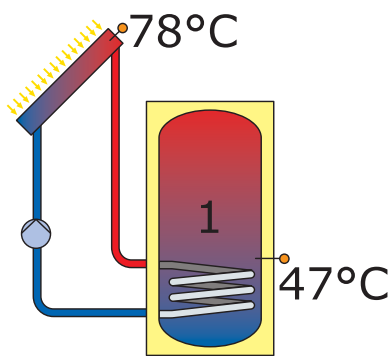

Active system with current temperatures

04.07.2015

10:35

Date and time

Display elements; example: information screen

Number and name of menu

1.3.2 Röhrenkollektor

Aktivierung

Start

n-solar 1

t-ein

T-ein

04.07.2015

10:35

Date and time

Professional mode

Manual mode

Message

Check box

Sub menu arrow

Selection menu

Activatable menu item

Scroll arrow

80%

10min

20.0°C

Display elements; example: communication screen



Danger!

Mortal danger due to electrocution! Whenever work is performed on the open terminal cover, all poles of the power supply must be disconnected reliably and protected against being switched on again!

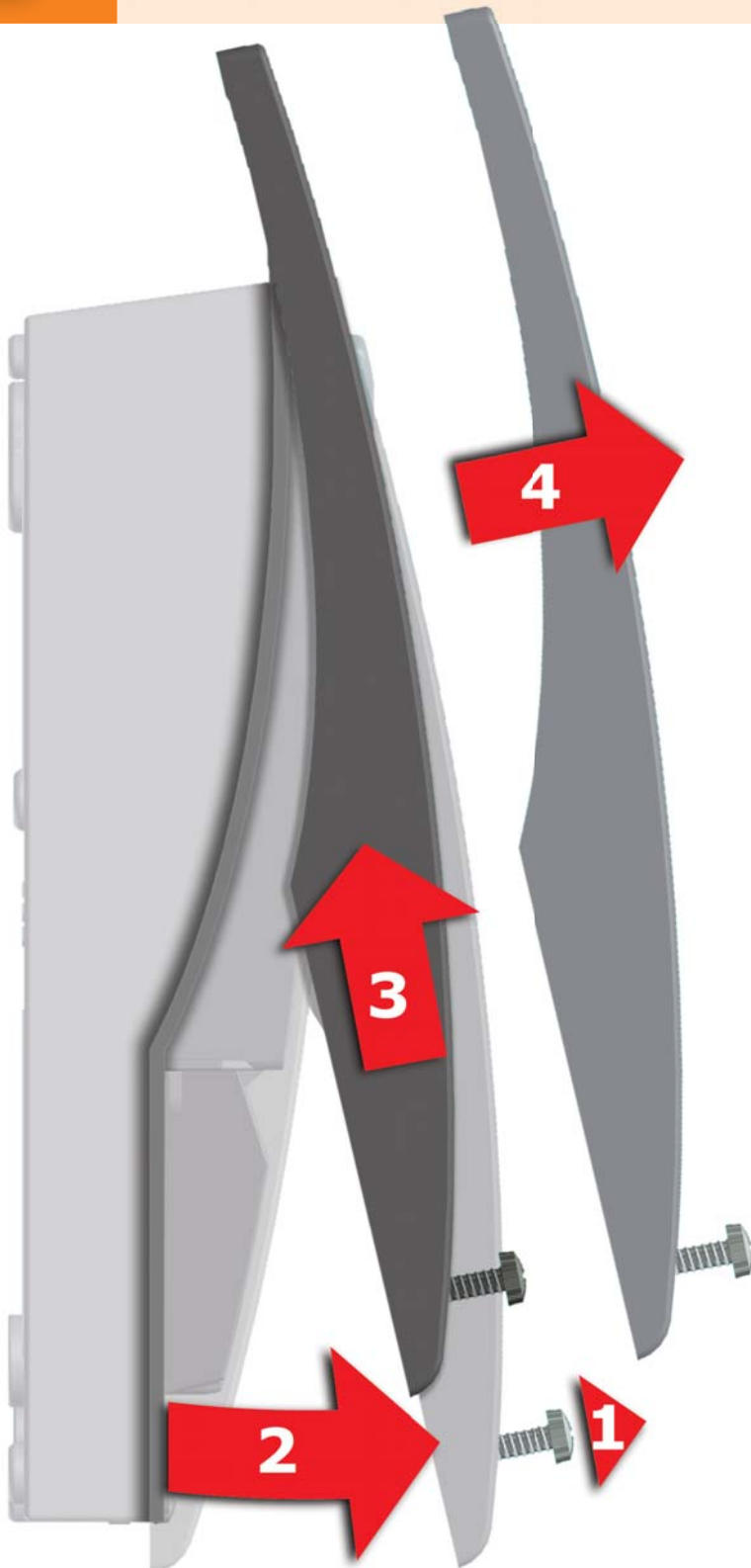

- 1** Release the lock screw.
- 2** Swing terminal cover forward ...
- 3** ... push it upwards ...
- 4** ... and remove it.

Store the terminal cover carefully and protect it against damage!

To close the terminal cover, reverse the opening procedure.



Important!

The device corresponds to protection type IP 20 - make sure the appropriate prerequisites exist on the envisaged place of installation.

Do not use the housing base as drill template.

A device with damaged housing must not be operated!

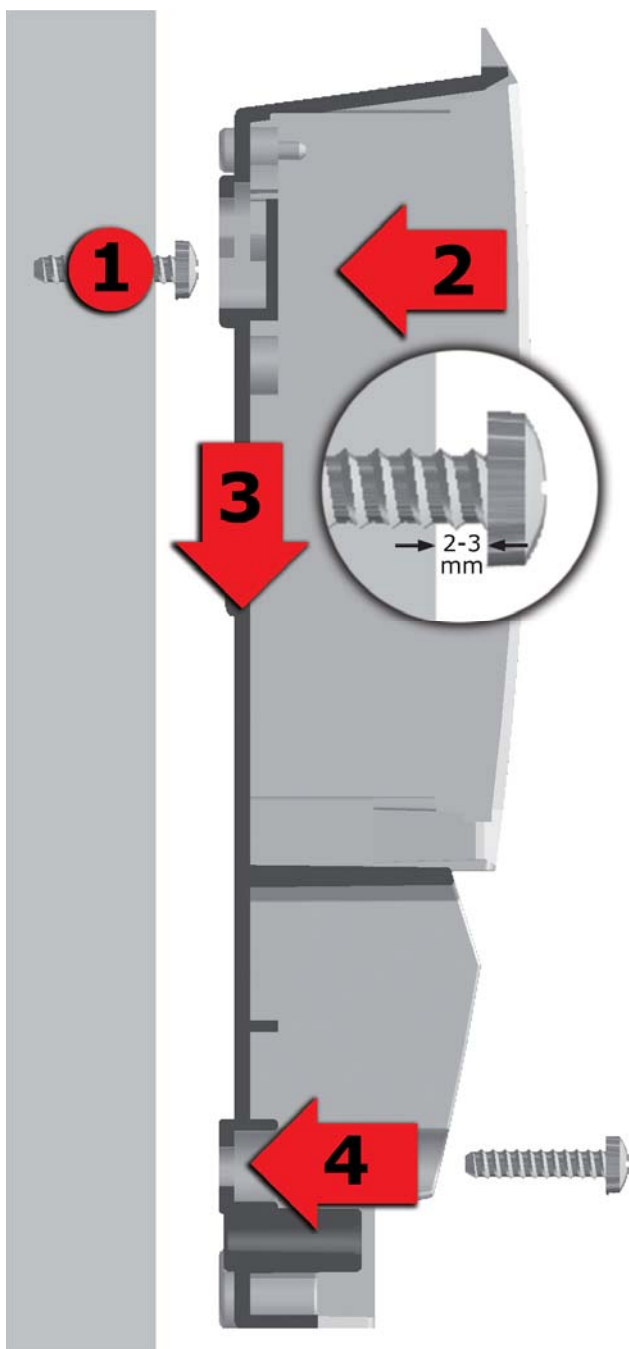

- 1** Fasten the top securing bolt so that a space of 2 to 3 mm is created between the wall and the screw head.
- 2** Move the device so that the upper fastening port is located above the screw head ...
- 3** ... and push it downwards.
- 4** Fasten the lower securing bolt.

If necessary, use dowel pins for wall-mounting!



Danger!

Mortal danger due to electrocution! Whenever work is performed on the open terminal cover, all poles of the power supply must be disconnected reliably and protected against being switched on again!



The differential temperature controller **smart Sol** is connected to the power supply four three groups of spring-type terminals which are visible once the terminal cover is opened.

To introduce the cables, release the three screws on the strain relief device; if necessary, remove the strain relief device.

In case of flush mounting of the cables, the break-out segments in the housing base can be removed carefully and the cables routed through these ports.

The central terminal block is the interface to a potential-free change-over contact - here, it may be necessary to route electrical resistors into the spring-type terminals and to connect part of the cables via luster terminals.

The spring-type terminals for the power supply, RO1, RO2 and REL, and for TS1 to TS8 can accommodate solid wires up to a cross section of 1.5 mm². Appropriate stranded wires must be preassembled with cable end sleeves.

For the strain relief device function, TS1 to TS7 and REL require cable cross sections of at least 5mm, for Power, RO1, RO2 at least 7mm. The strain relief fixture can be slightly reworked to fit larger cable diameters without producing sharp edges. For a larger number of sensor lines, cable straps can be used to support the strain relief.

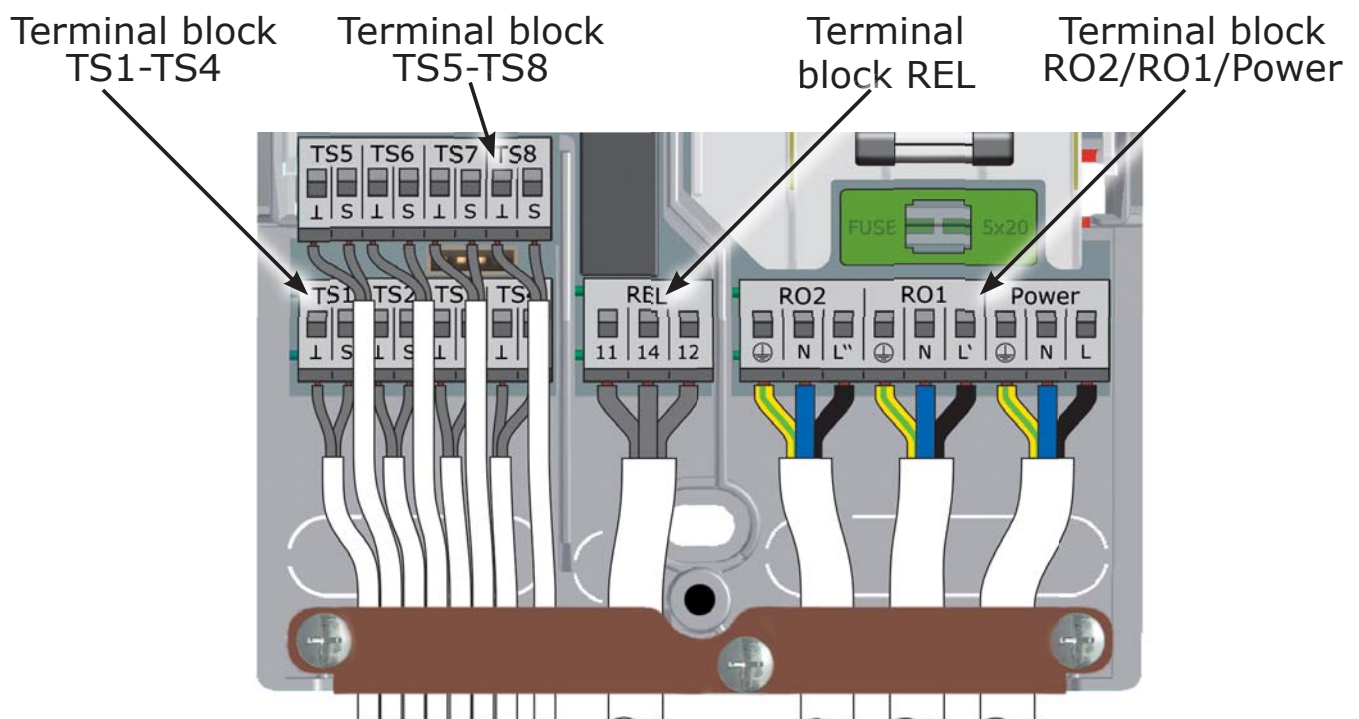

Connection of a switching valve to RO1/RO2

Connection diagram for a switching valve without power supply to RO2:

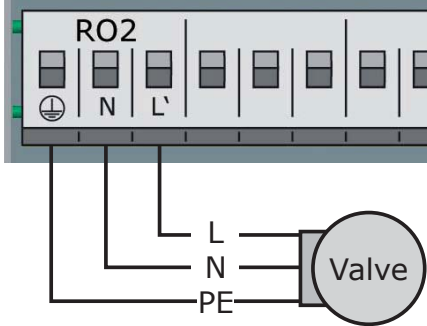

Connection diagram for a switching valve with power supply to RO2:

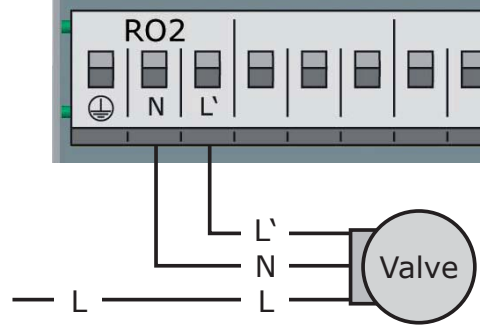

Connection of a switching valve to REL

Connection diagram for a switching valve without power supply to REL:

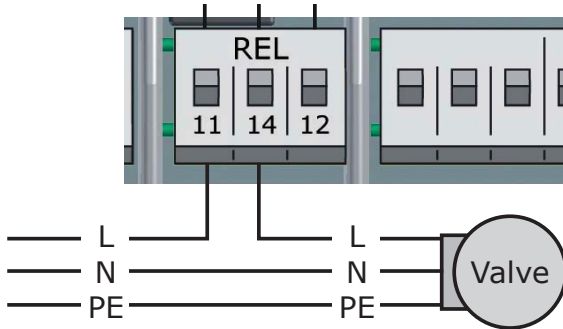

Connection diagram for a switching valve with power supply to REL:

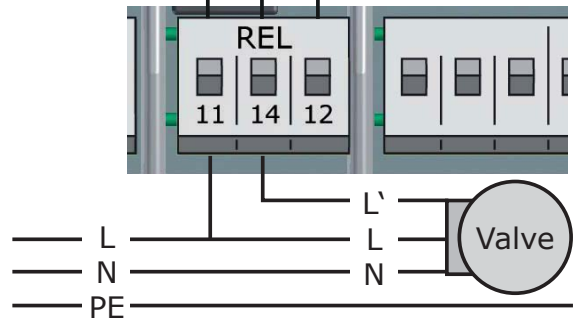

Connection of a pump to REL

Connection diagram for a pump to REL:

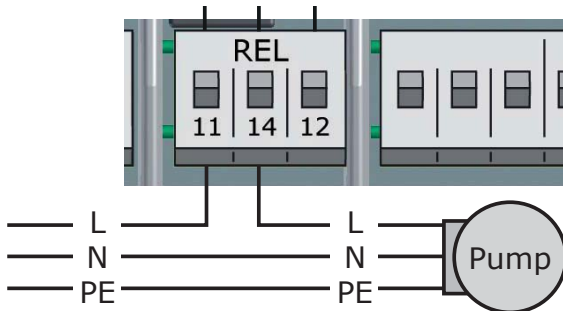

Volumetric flow sensor:

Measurement of solar radiation (heat quantity):

The solar yield is calculated from the flow rate and the differential temperature. The differential temperature is the difference in the temperature of the collector sensor and the solar circuit return line sensor. There are various technical options:

a) Use of a vortex volumetric flow sensor with 2 analog signals for flow rate and temperature. The vortex sensor can be inserted directly at the plug connector provided behind the TS3/4 terminals. All plant layouts permit solar radiation measurement.

Pin assignment

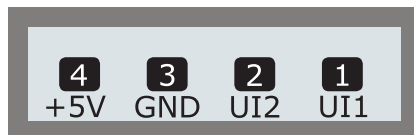

b) Impeller sensor (incrementation input)

An impeller sensor can be connected to TS6 and must be adjusted during installation. The temperature sensor for the solar return line must be set in the menu >1.1.4 Heat quantities<.

All plant layouts permit solar radiation measurement using an impeller sensor.

High-efficiency pump:

A high-efficiency pump can be connected via RO1 or RO2.

The appropriate control signal is issued at TS7 / TS8 / (TS4).

Thus, TS4 is no longer available as input.

The control signal may be an analog voltage 0 - 10V or a PWM signal.

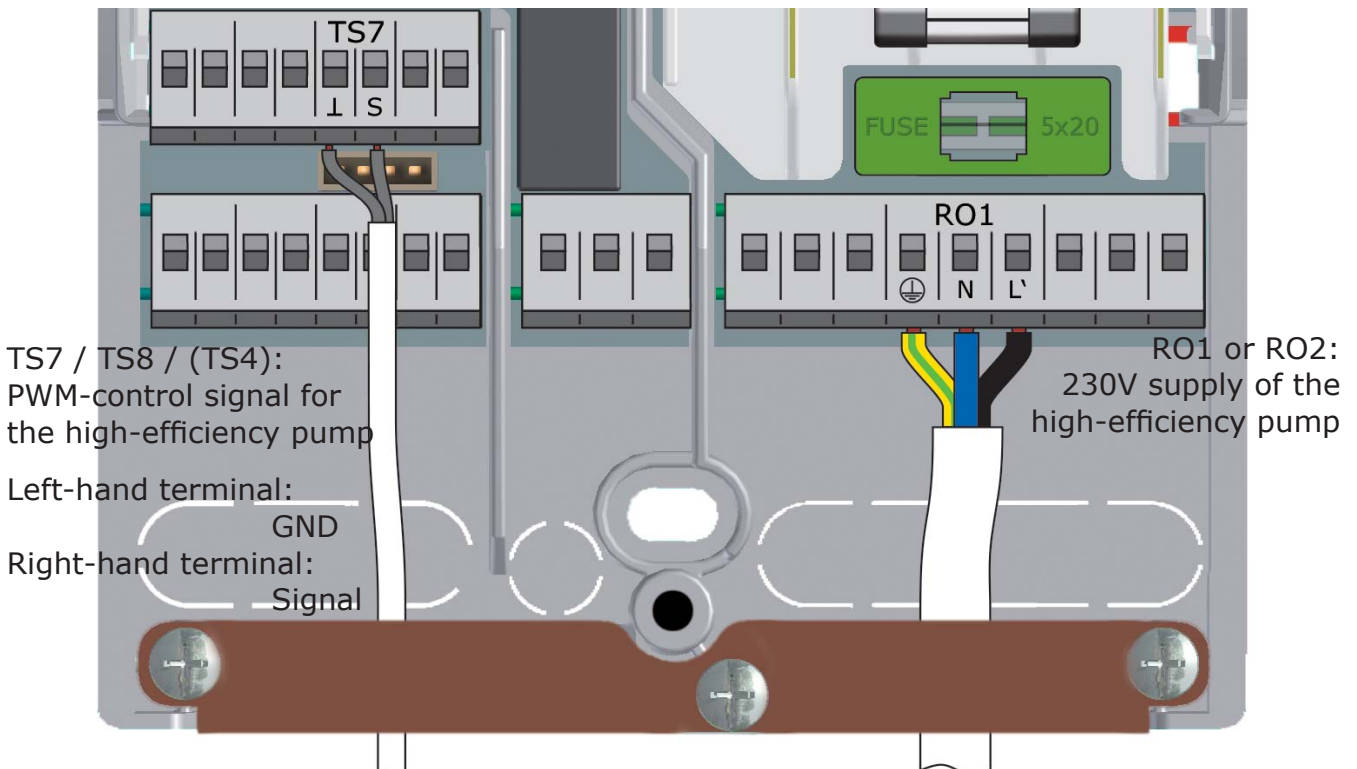

For further details, please refer to the pump specification.

For definition and settings, the professional mode under 1.3.7 has been provided.

Important!

Depending on whether HE pumps are used as solar or heating pumps, they are supplied with proportional or inverted control signals. (Both analogue and PWM control.)

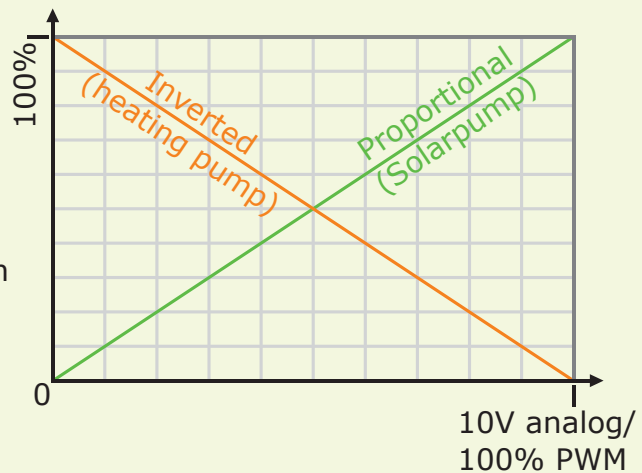

The strain relief device can only ensure solid clamping if the cables are not stripped to a length of over 35 mm.

Insulation of the individual wires must be removed over a length of 9 - 10 mm to ensure safe electric contact in the spring-type terminal.

Stranded wires must be provided with cable end sleeves!

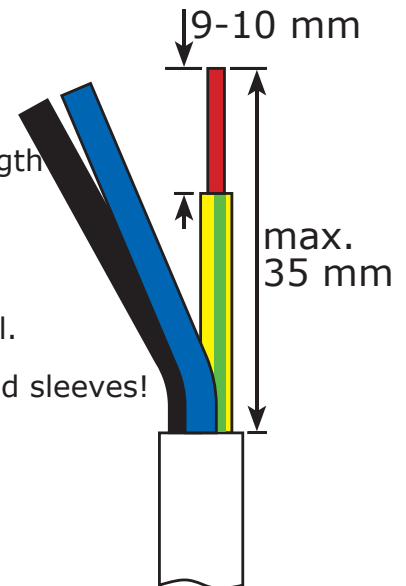

For connection, press the actuation pushbutton of the spring-type terminal using a screwdriver and insert the wire to its stop in the appropriate port.

Release the actuation pushbutton and pull the cable slightly to ensure that it is safely clamped.

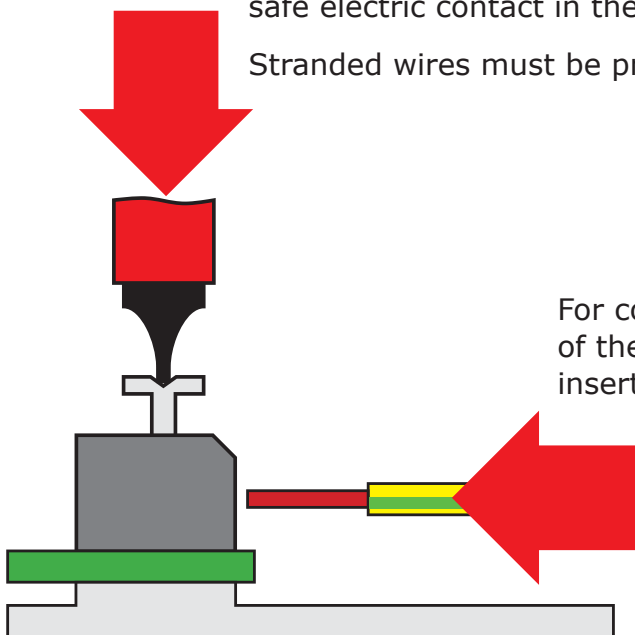

Important!

Before closing the terminal cover, make sure the strain relief device is tightened safely.

Check once more that all cables are in good condition and connected correctly.



The solar controller has the following data interfaces:

The cut-outs at the left of the housing base accommodate a USB port as well as a slot for a storage medium (Micro SD card).

These interfaces are used, for example, for reading of error messages or log data or loading of software updates.

The USB port provides access to the Micro SD card.

Only SD cards approved by the manufacturer must be used. The controller automatically detects the Micro SD card.

Prior to removing the Micro SD card >Rem.SD card safely< must be selected in >1.2 Settings<, otherwise data loss may occur.

Since the controller can only read formatted SD cards, the micro SD card must be formatted with a PC.

Note!

SD cards recommended by the manufacturer:

Transcend®	2GB	Transcend 2GB Produkt-Nr. TS2GUSDC
Transcend®	4GB	Transcend 4GB HC
Transcend®	1GB	Transcend 1GB
Verbatim	2GB	Verbatim 2GB
PNY	2GB	PNY 2GB
hp	2GB	hp 2 GB
SanDisk	2GB	SanDisk 2GB



Note!

Define structure and design of the plant already when planning the entire solar thermal system and align the design with the one of the hydraulic systems of the controller!

If you want to complete an existing system or replace the existing controller, please make sure that **smart Sol** is compatible with the existing configuration!

The sensors are connected to TS1 to TS4, the order not being significant; pumps and valves are connected to RO1 / RO2 - The interfaces are assigned to the functions in question on commissioning.

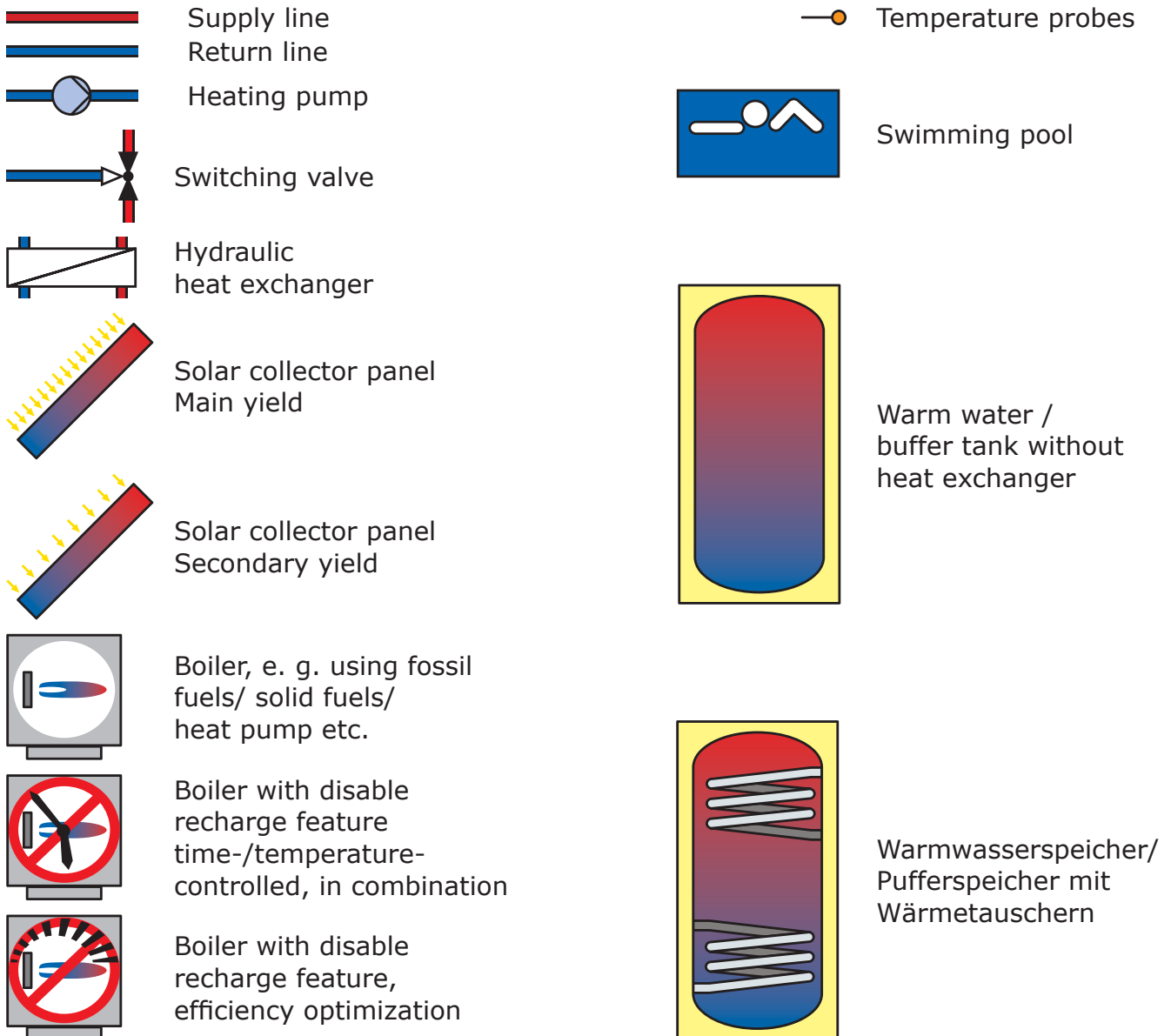

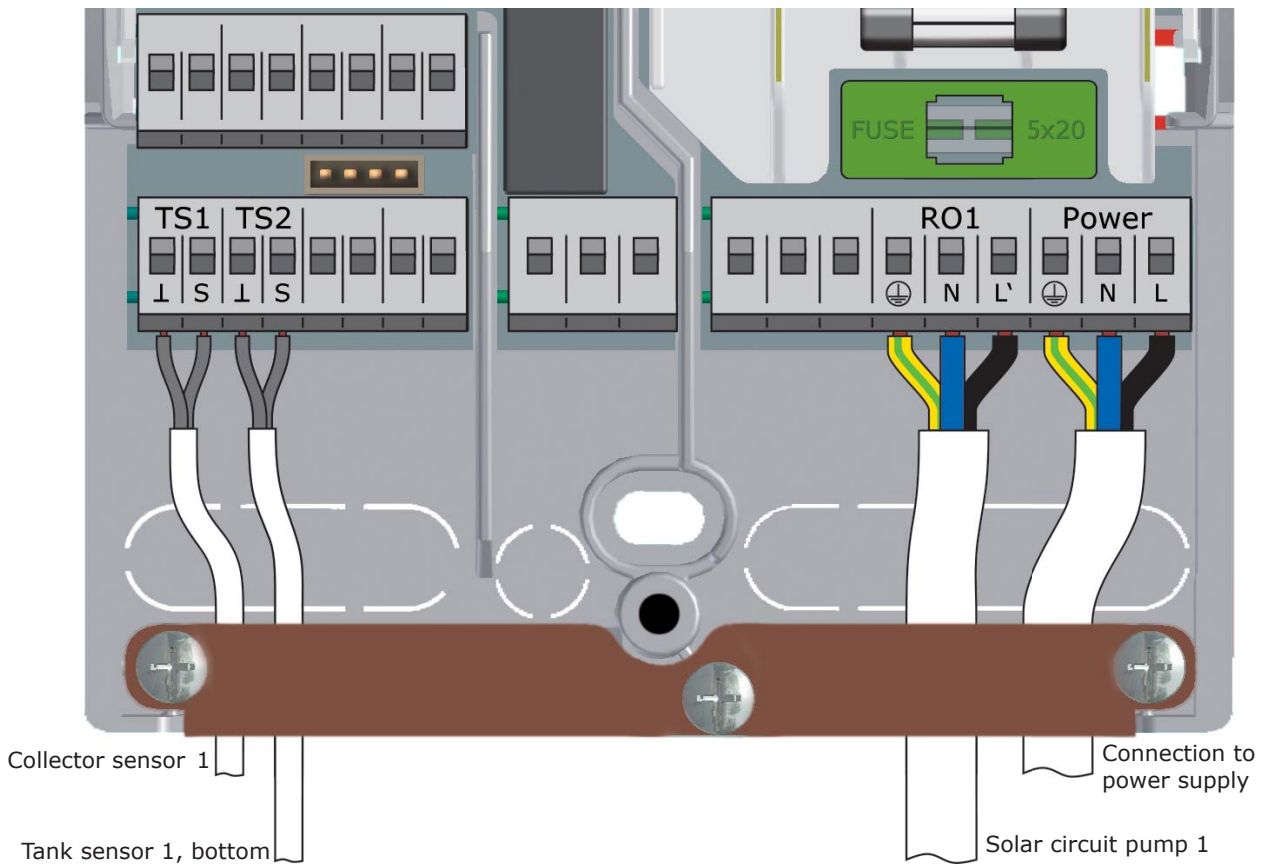
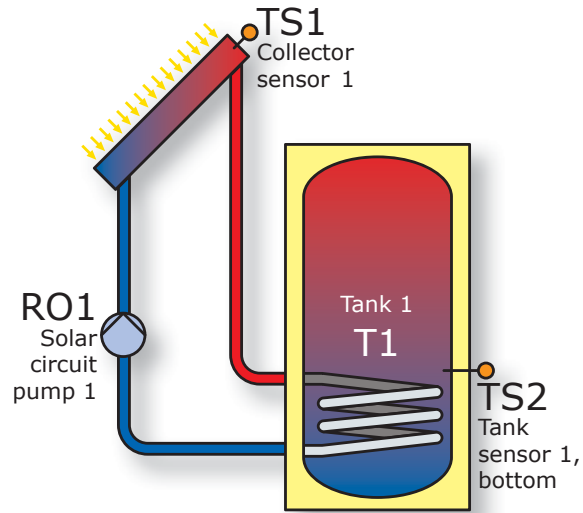

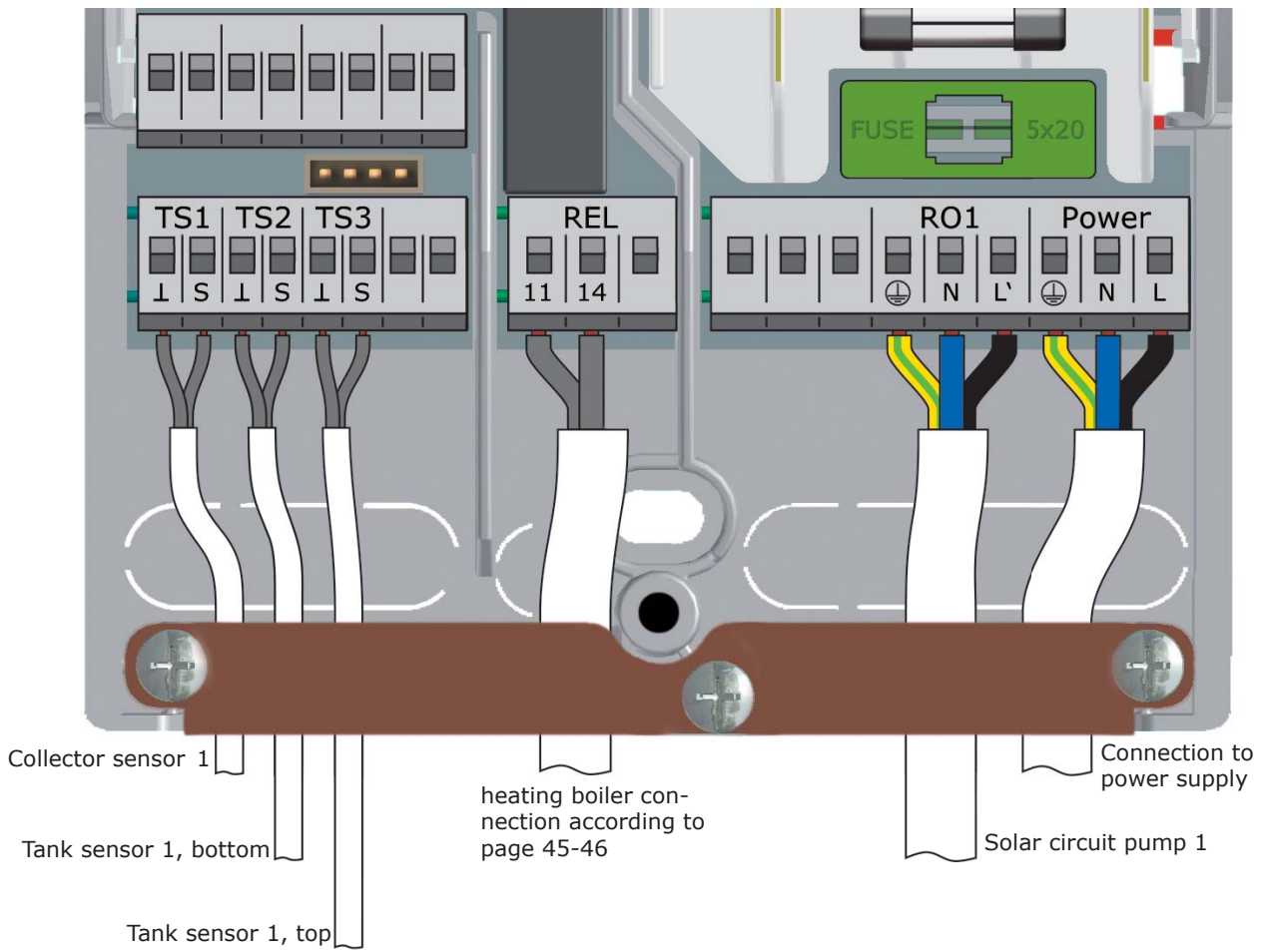
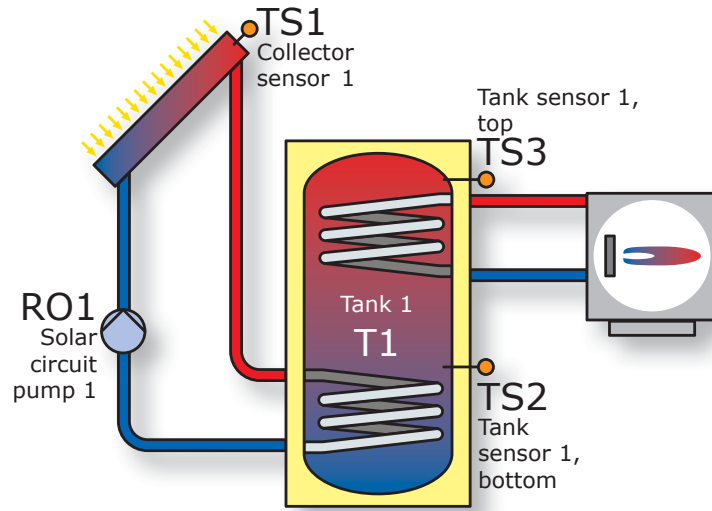

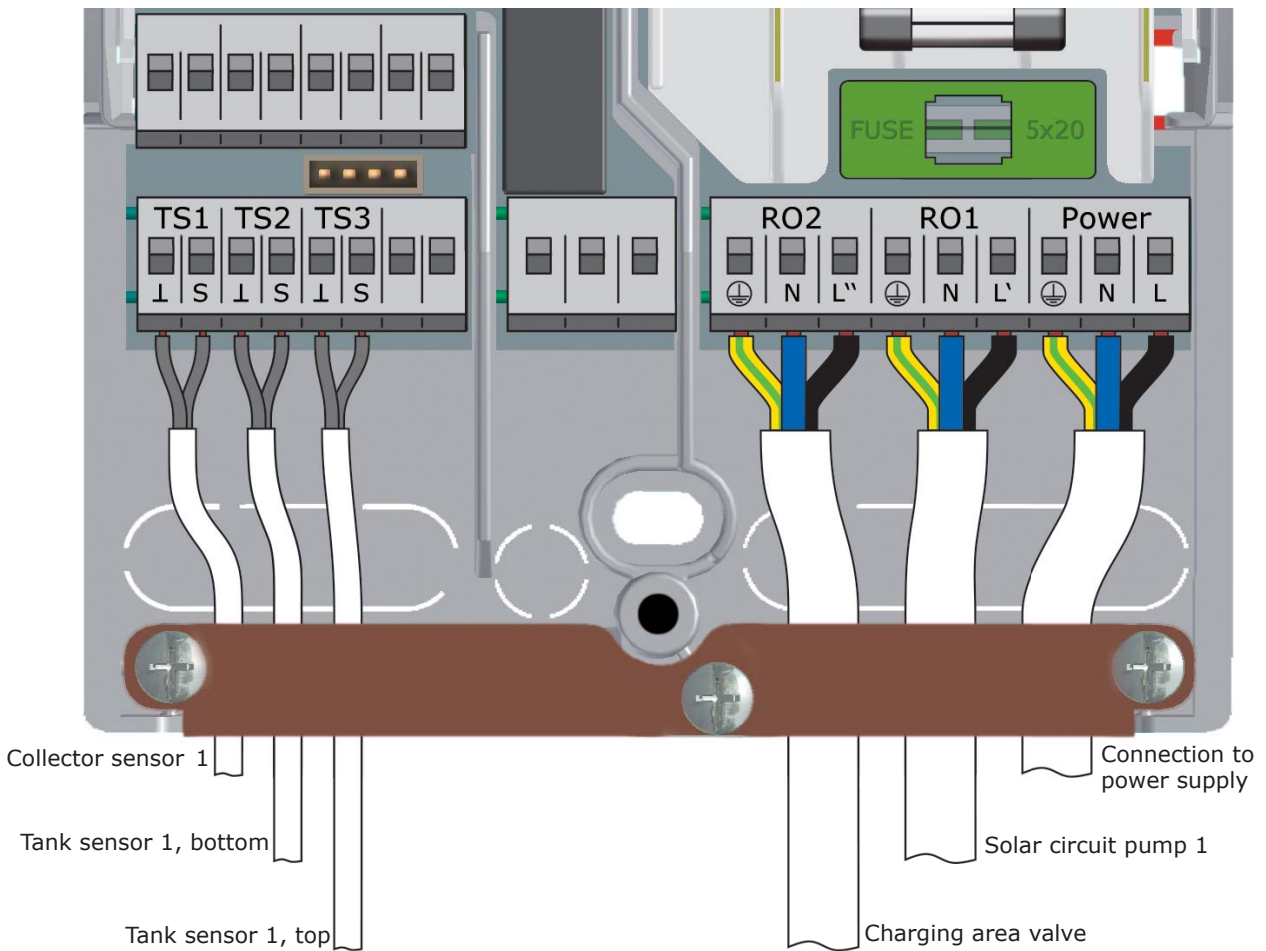
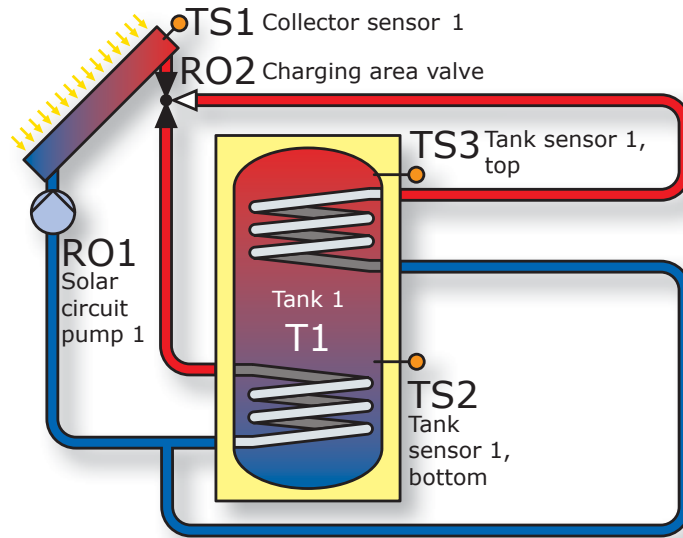

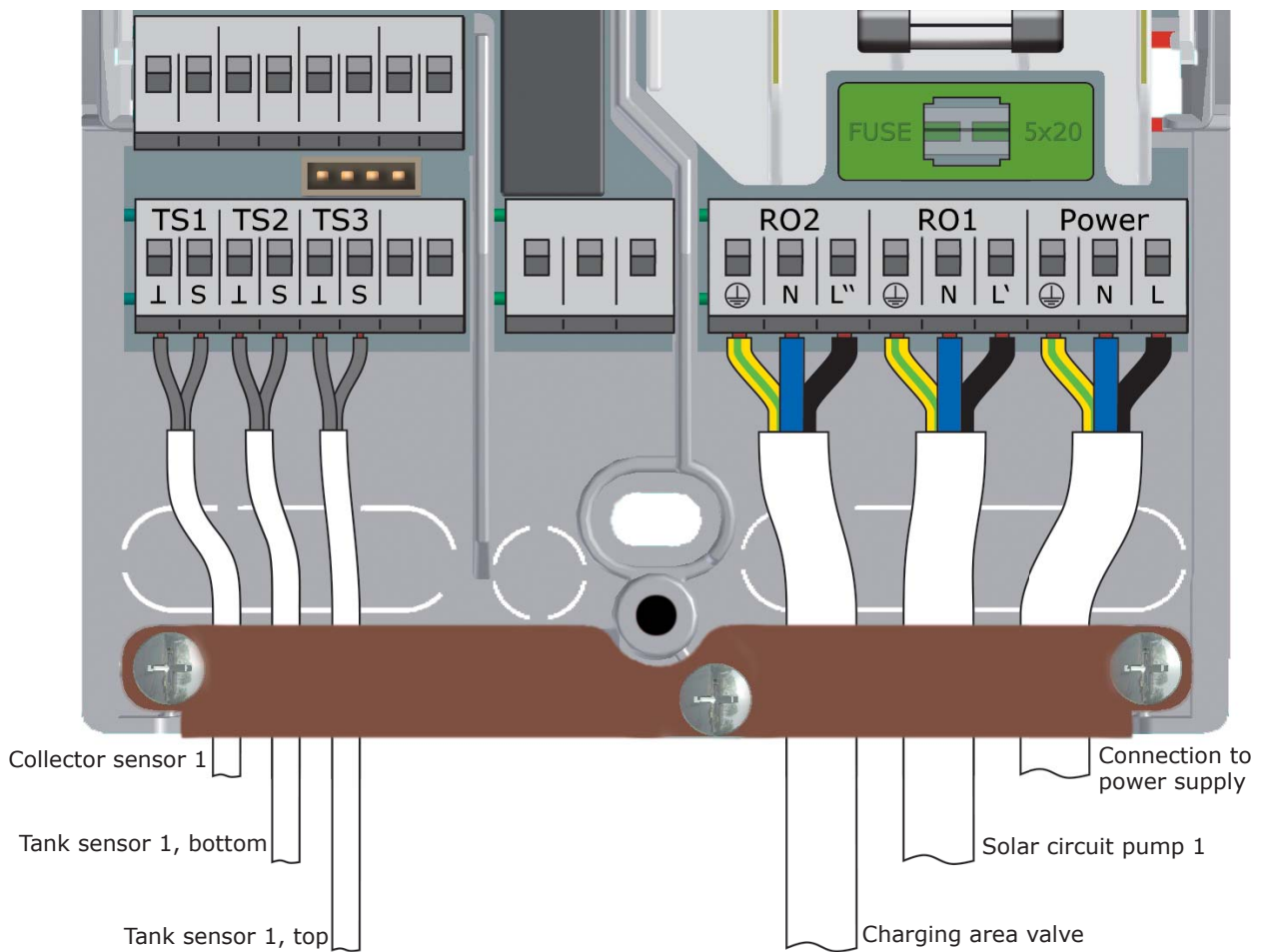
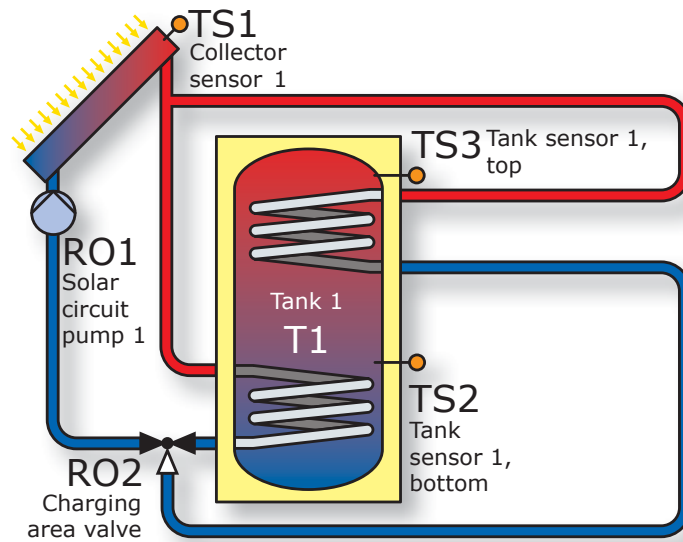

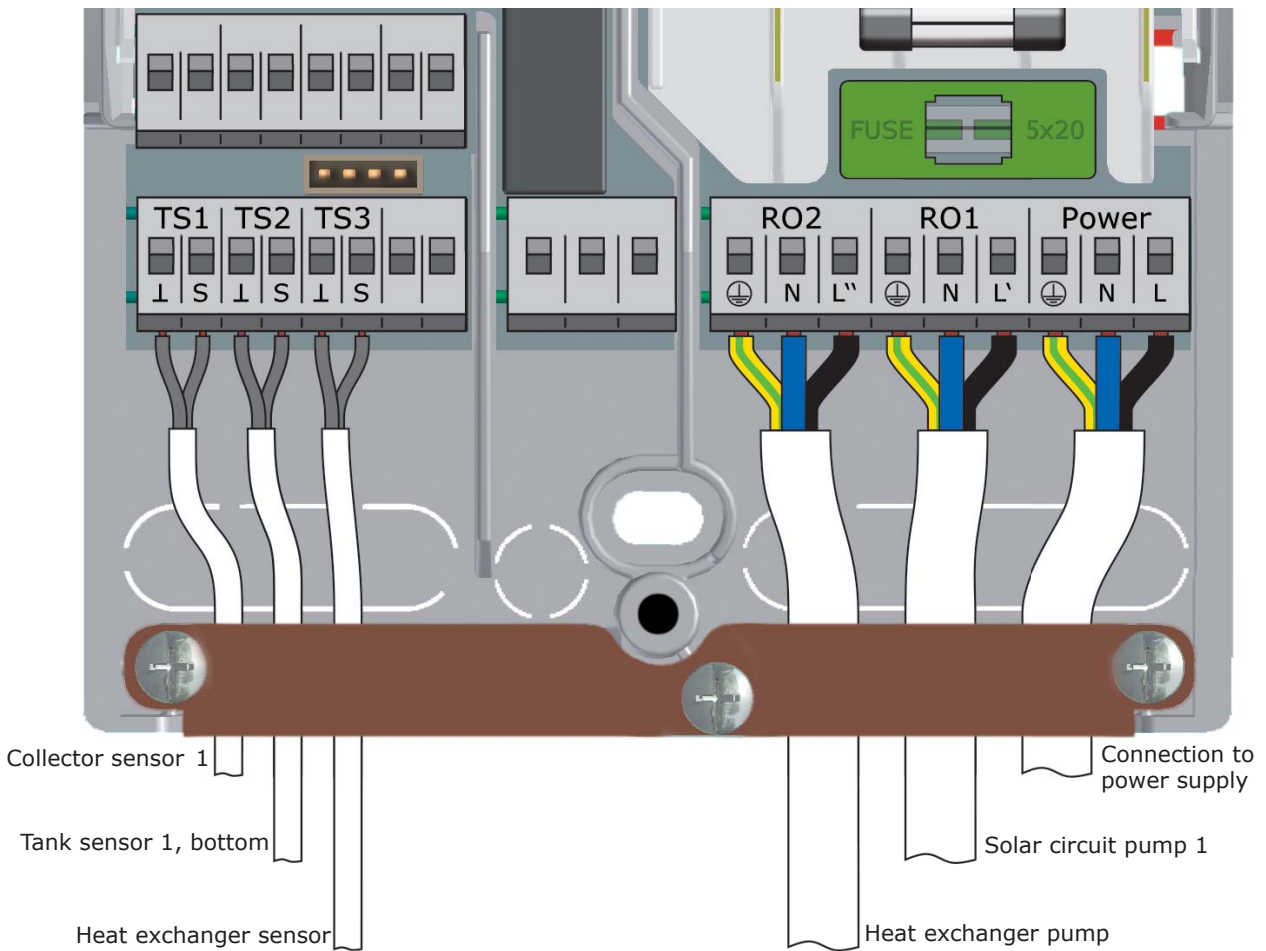
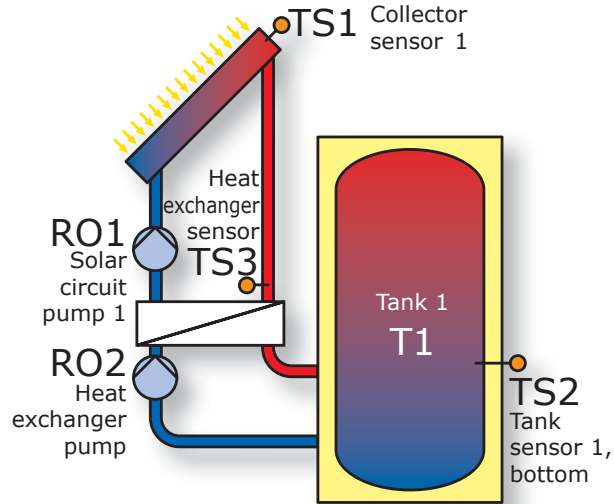

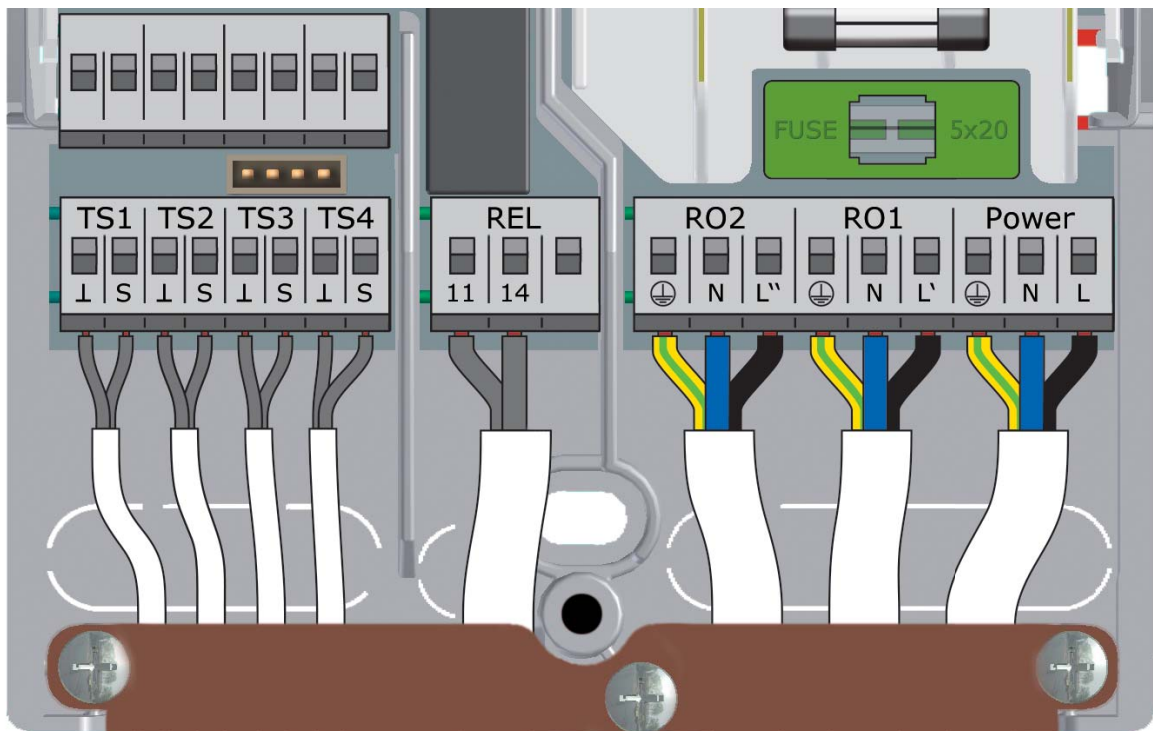
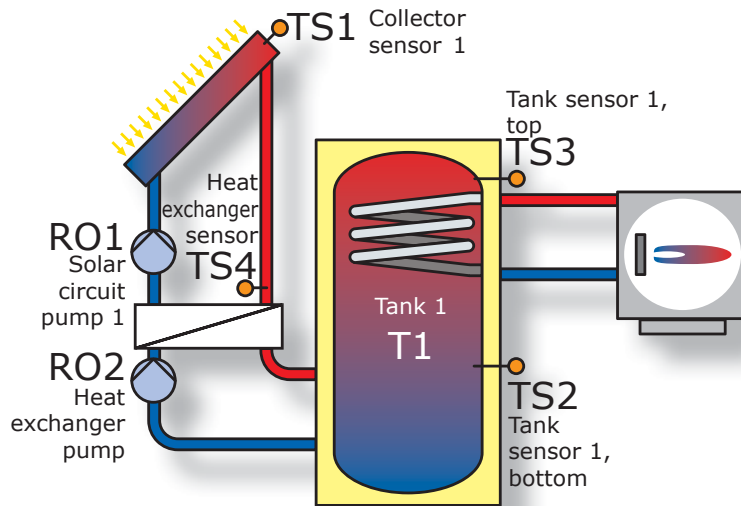

- Collector sensor 1
- Tank sensor 1, bottom
- Tank sensor 1, top
- Heat exchanger sensor
- Heating boiler connection according to page 45-46
- Connection to power supply
- Solar circuit pump 1
- Heat exchanger pump

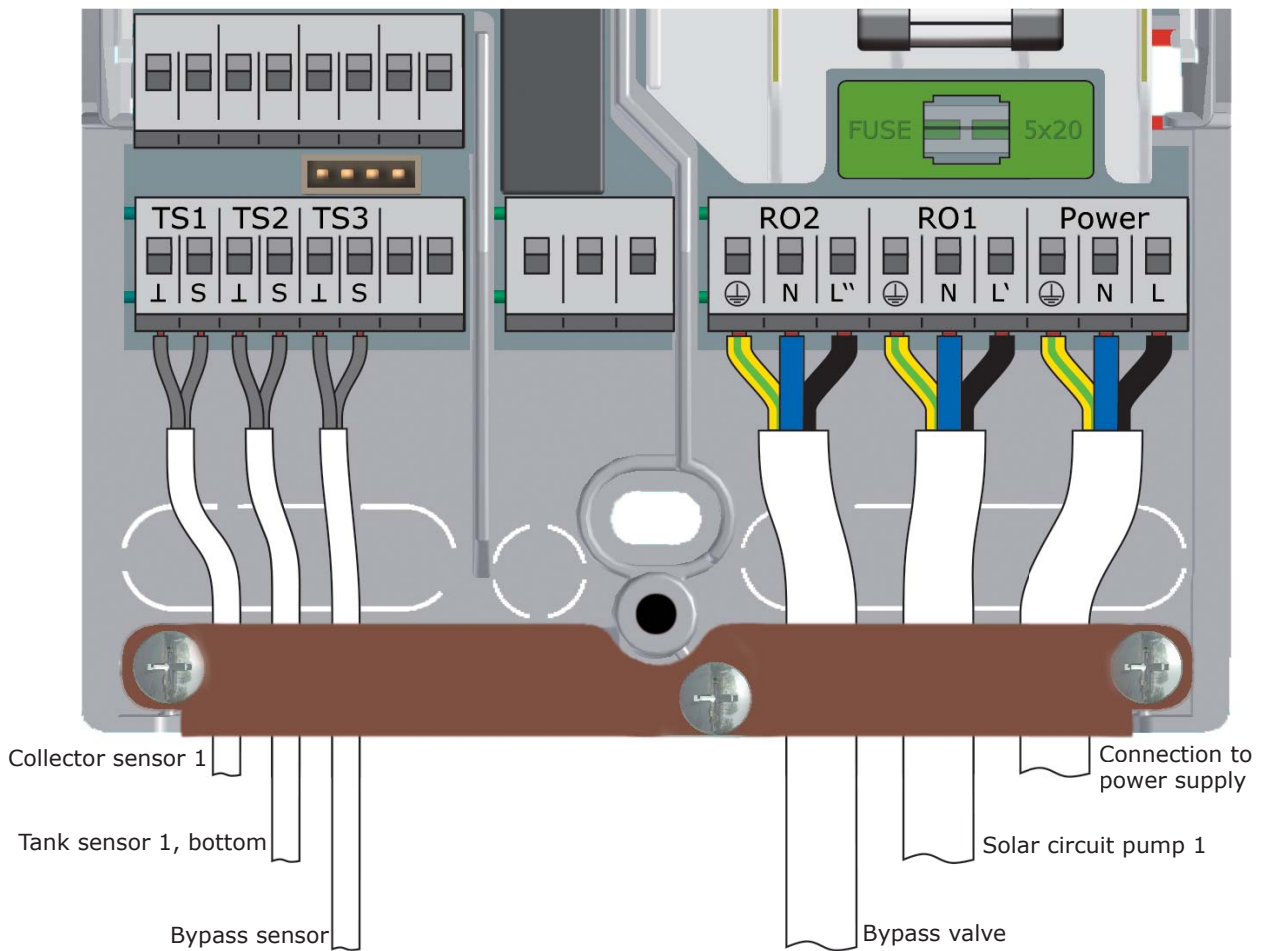
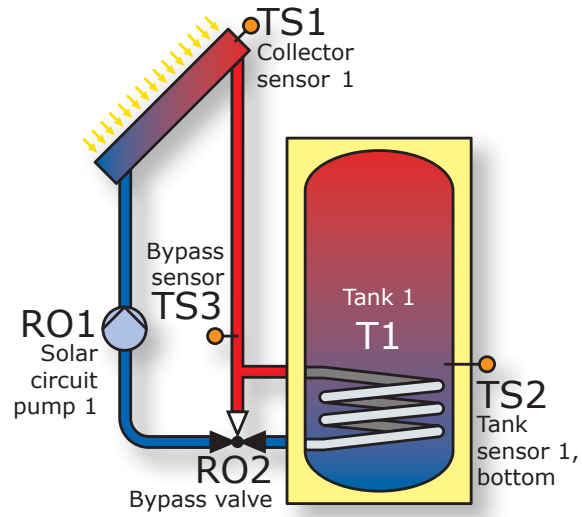

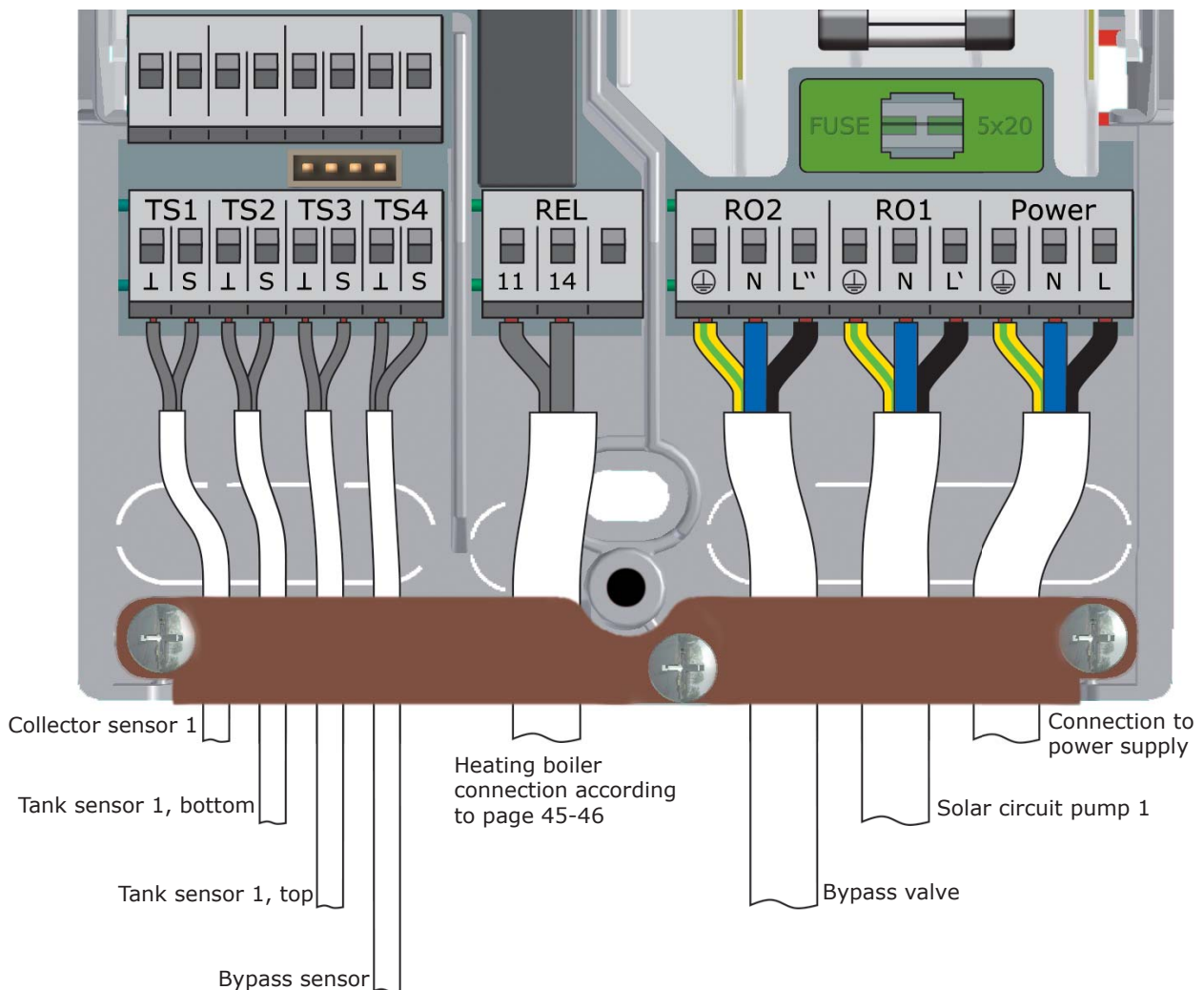
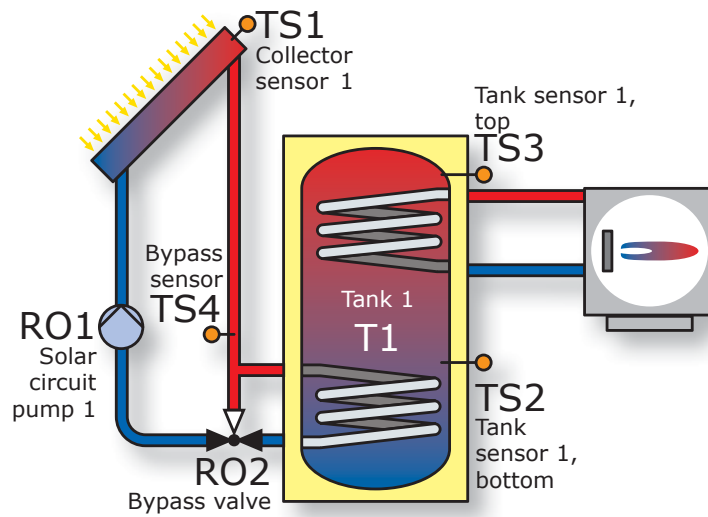

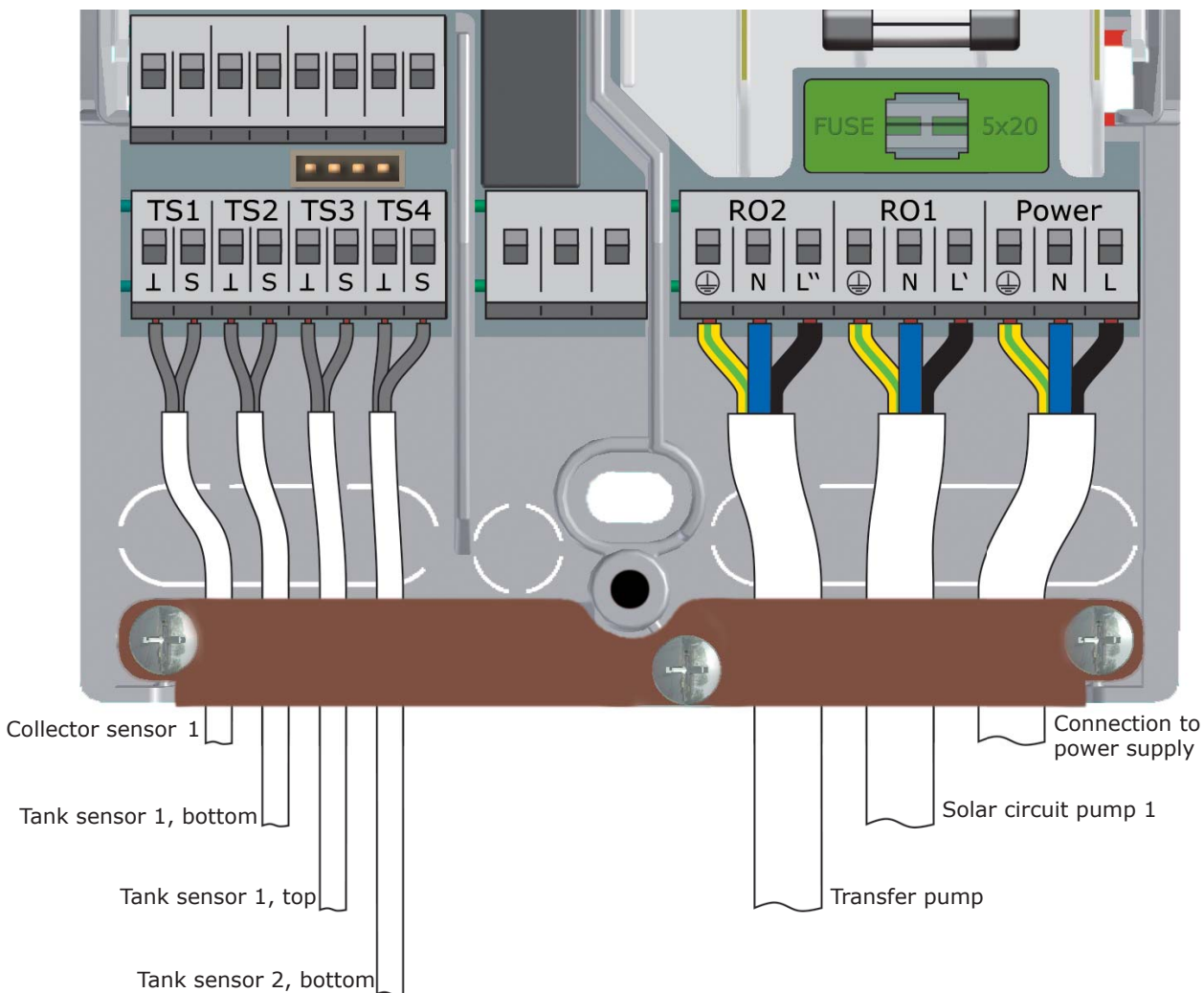
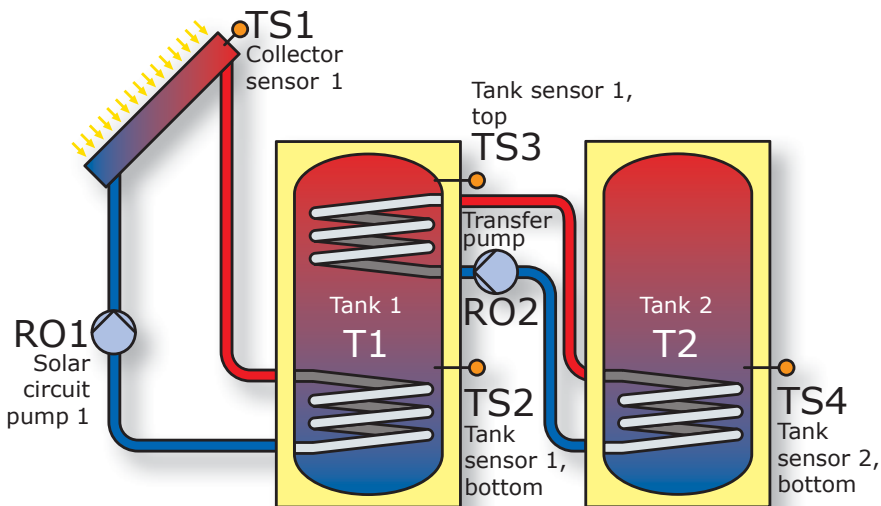

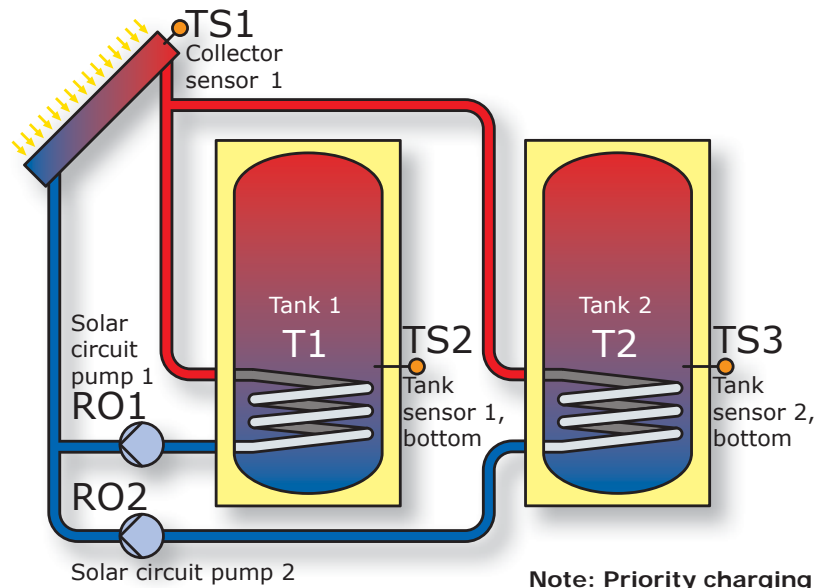

Note: Priority charging has been set to T2 in the factory.

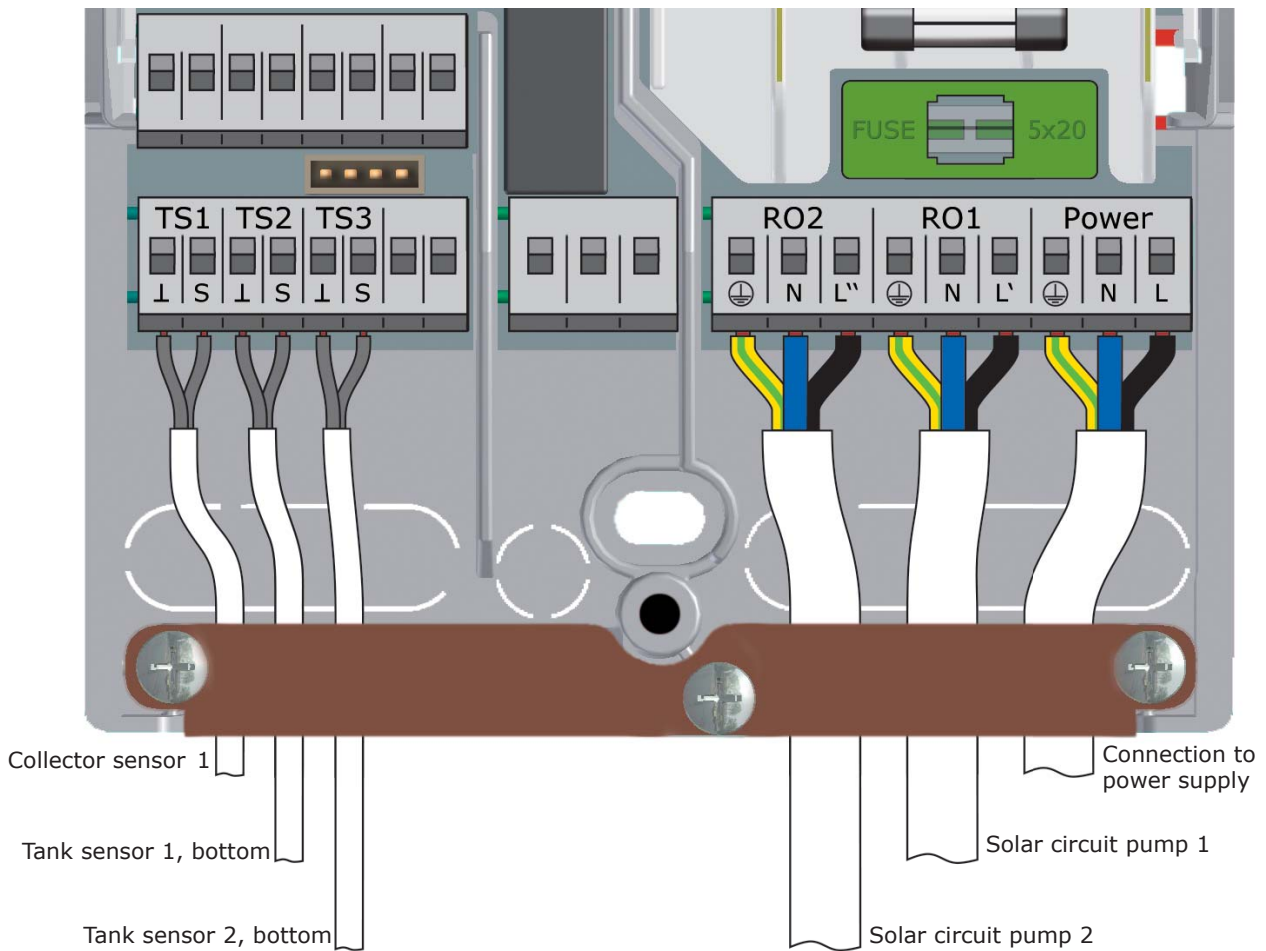

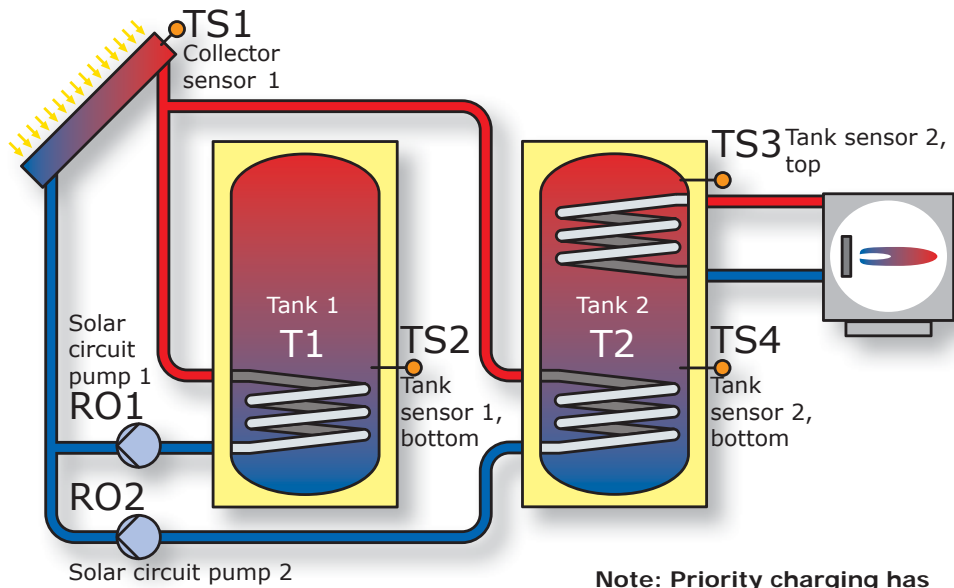

Note: Priority charging has been set to T2 in the factory.

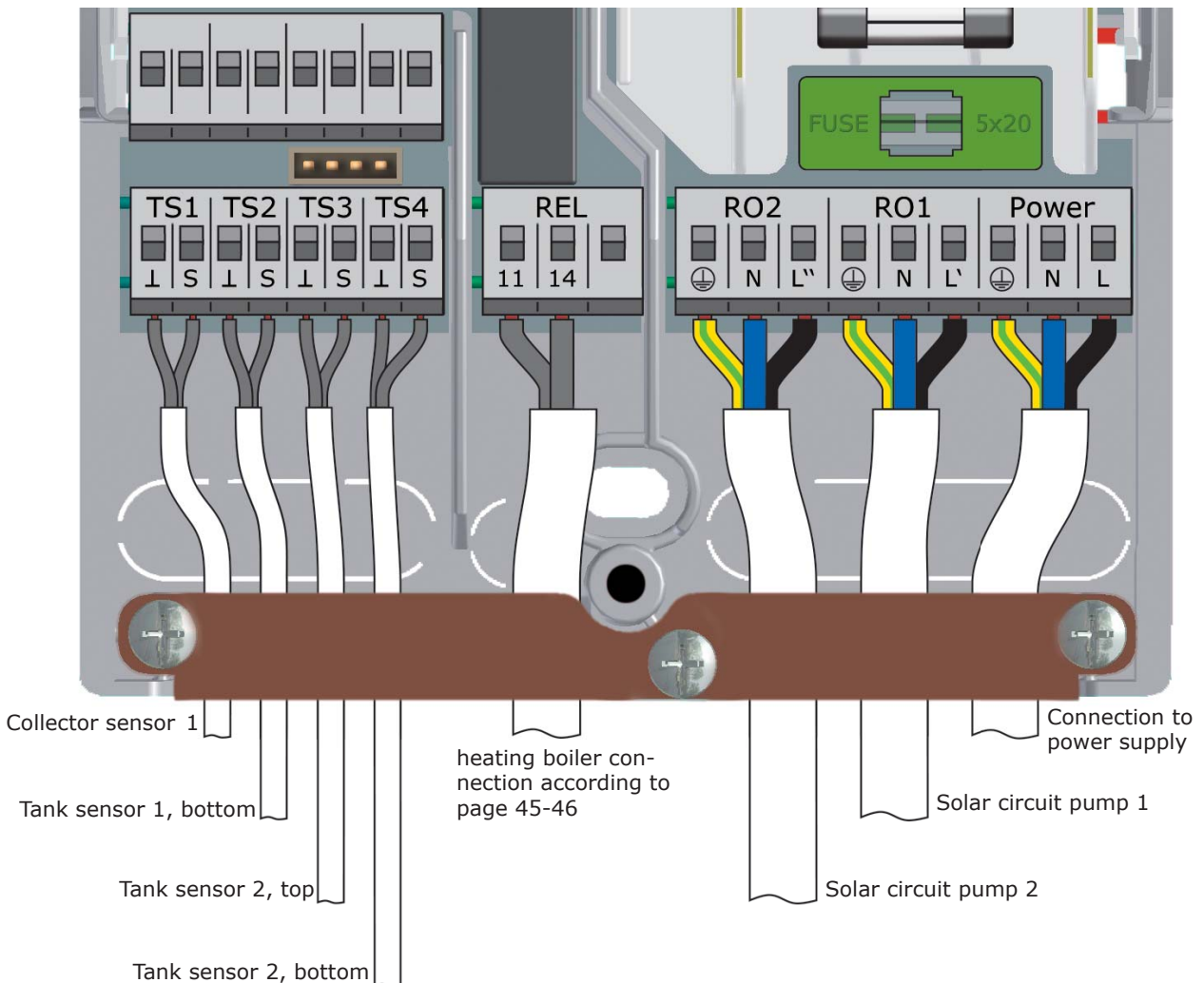

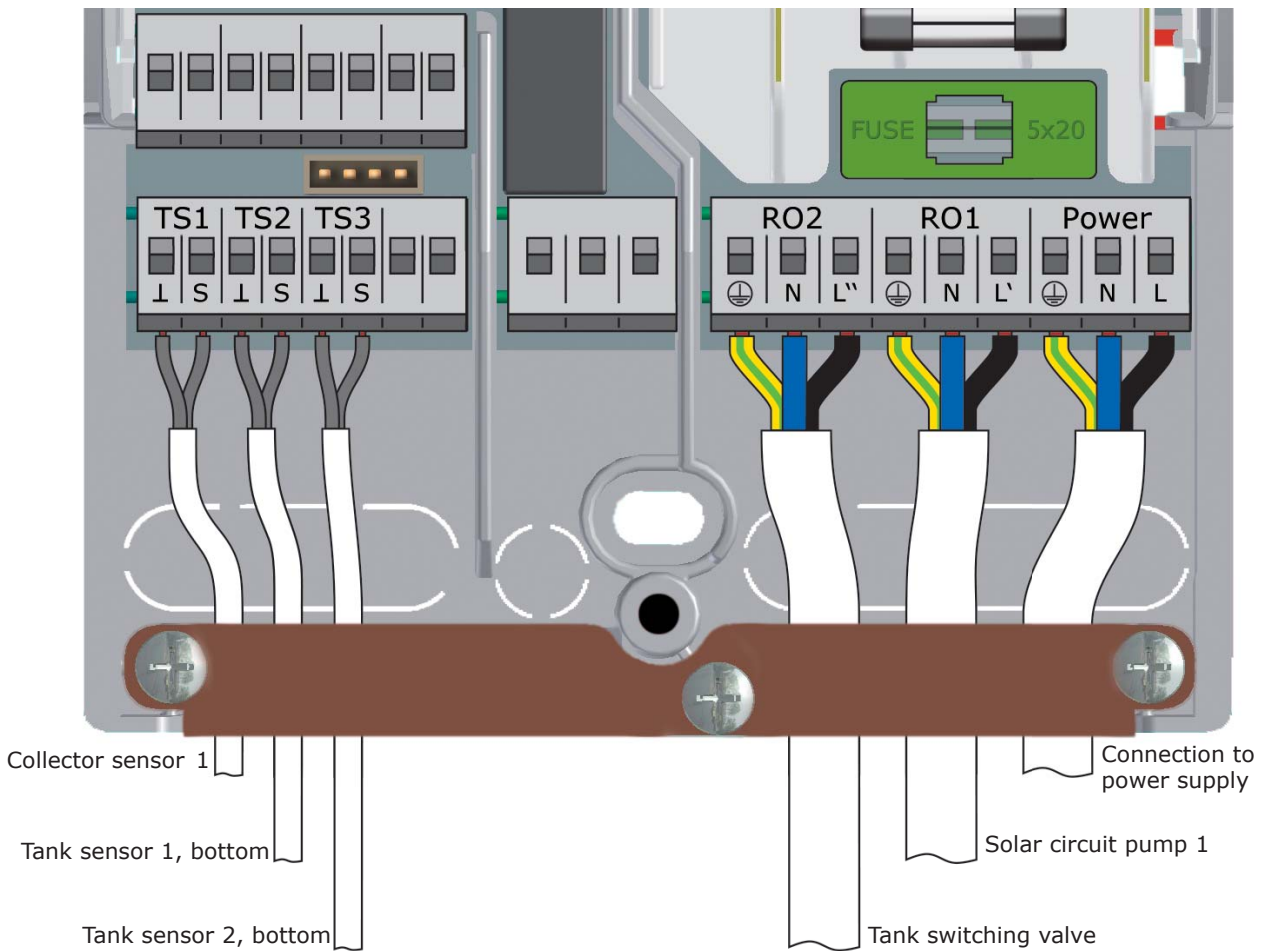
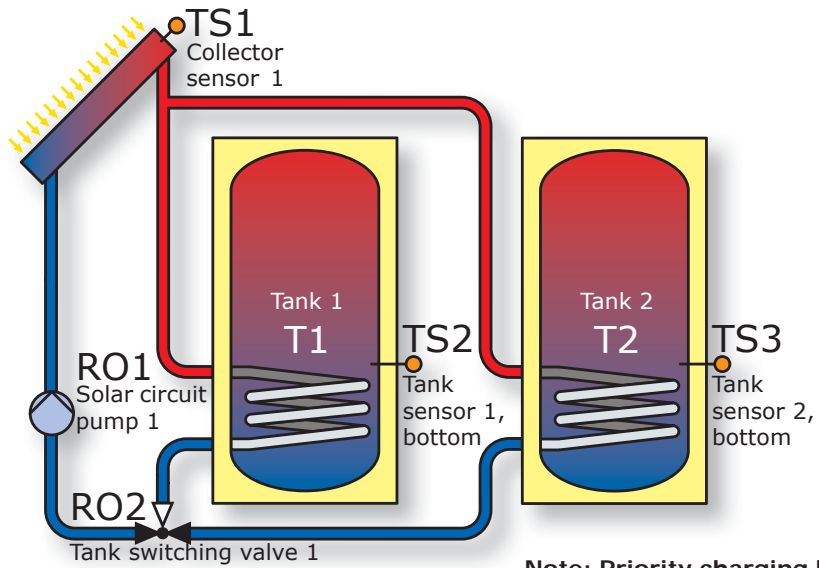

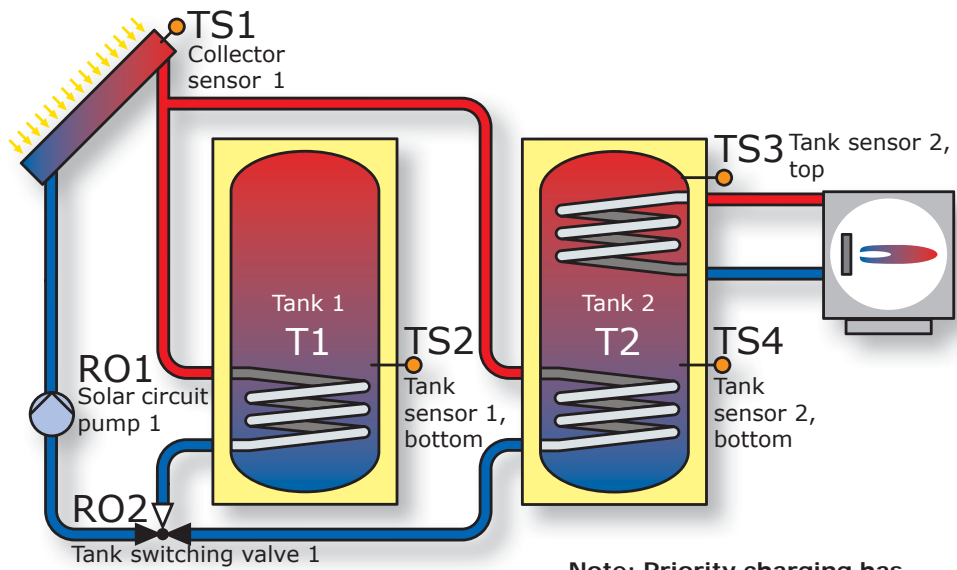

Note: Priority charging has been set to T2 in the factory.

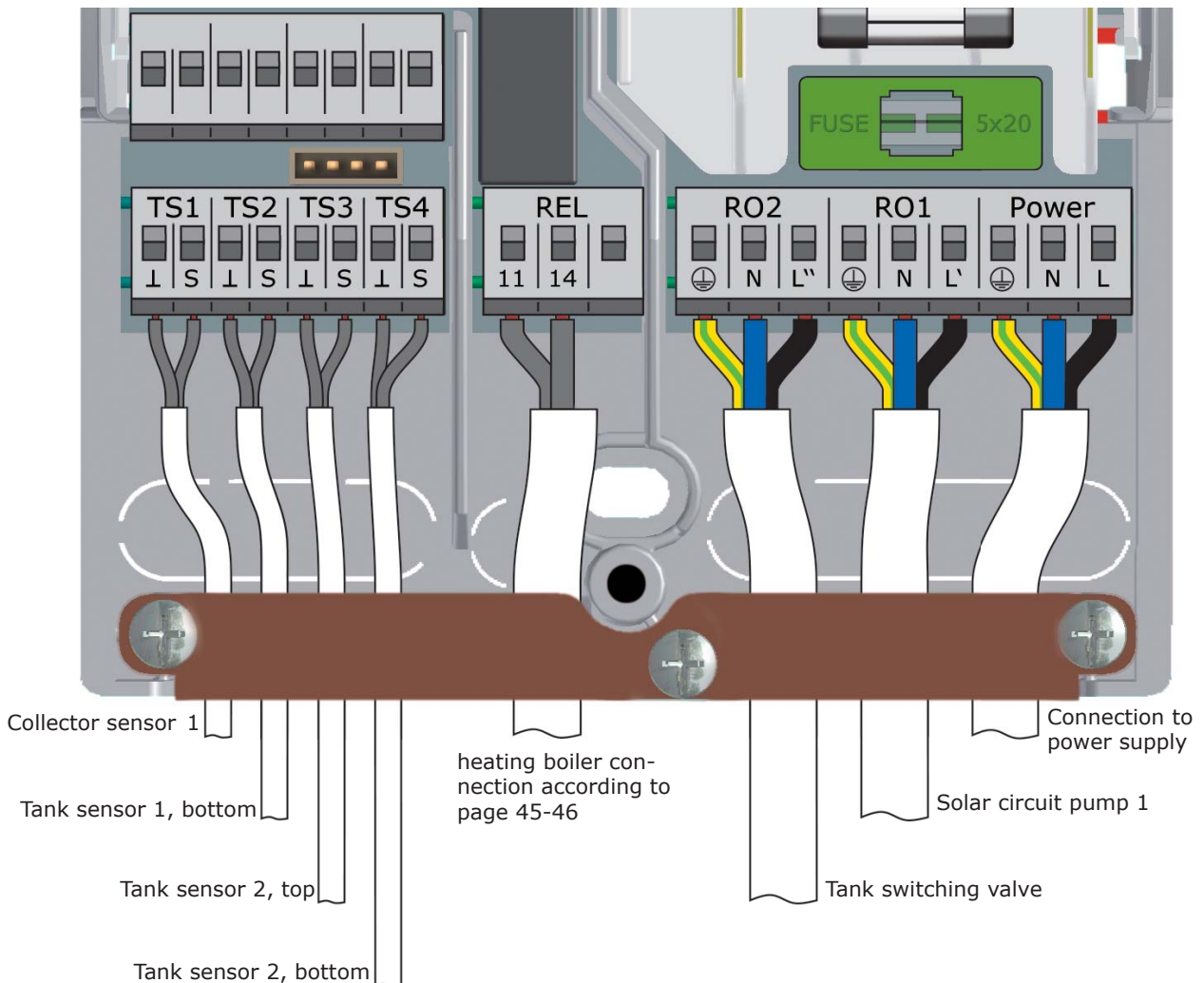

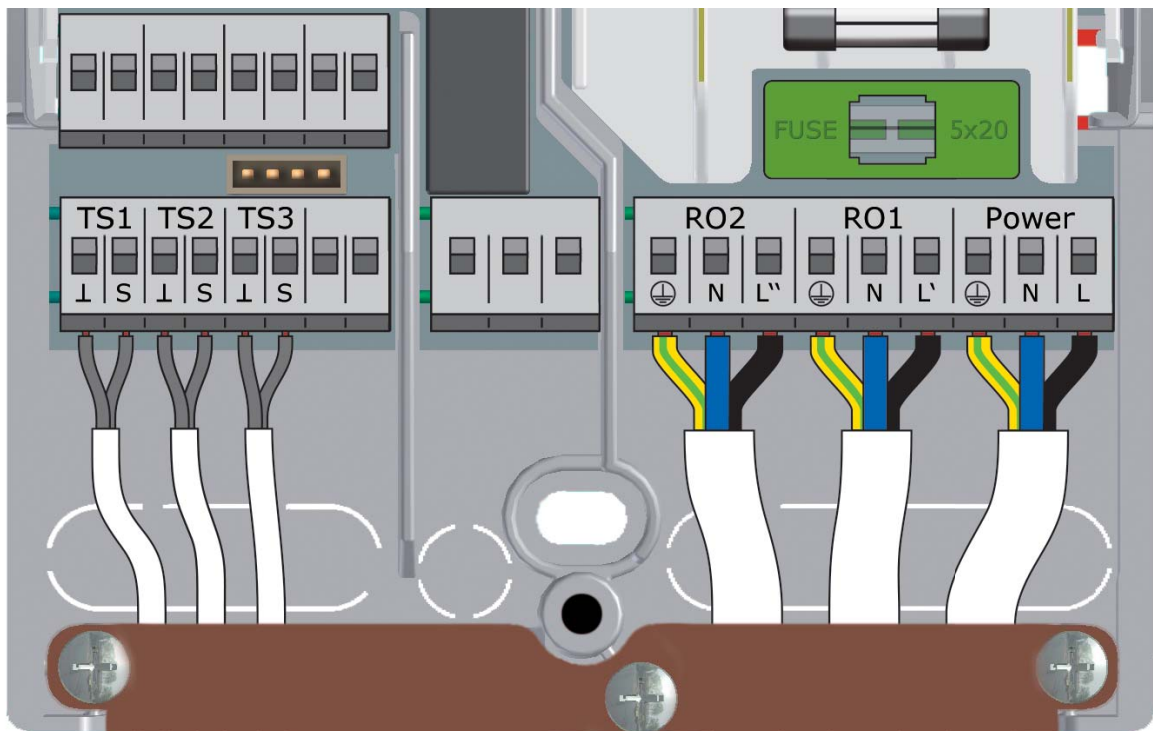
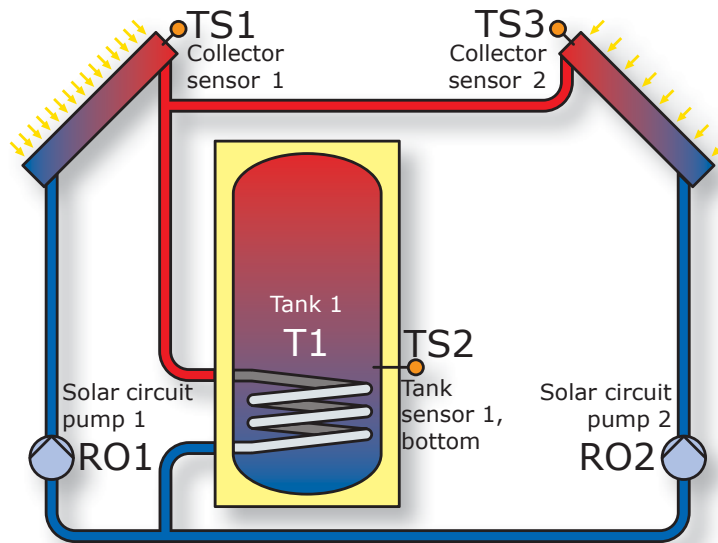

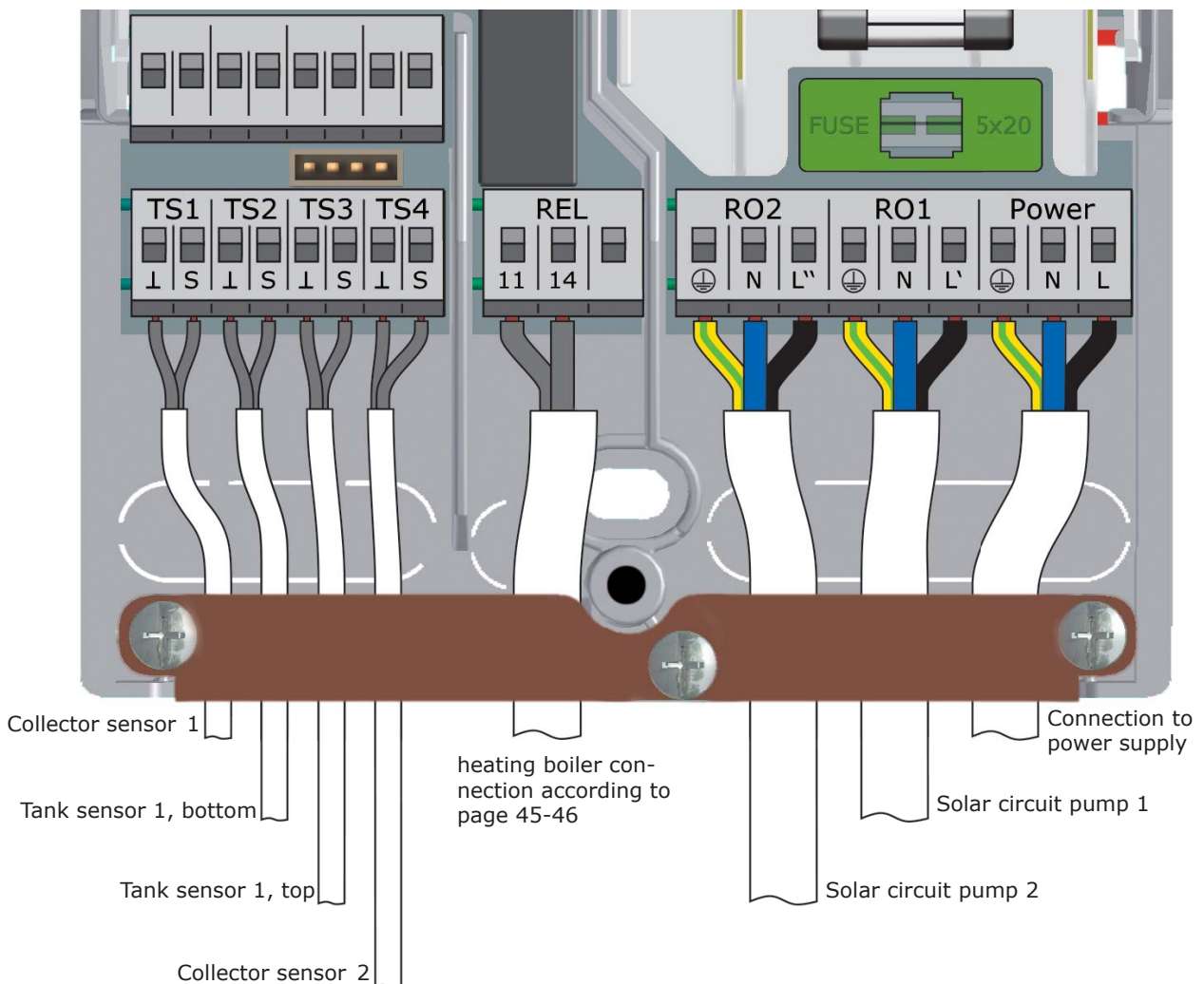
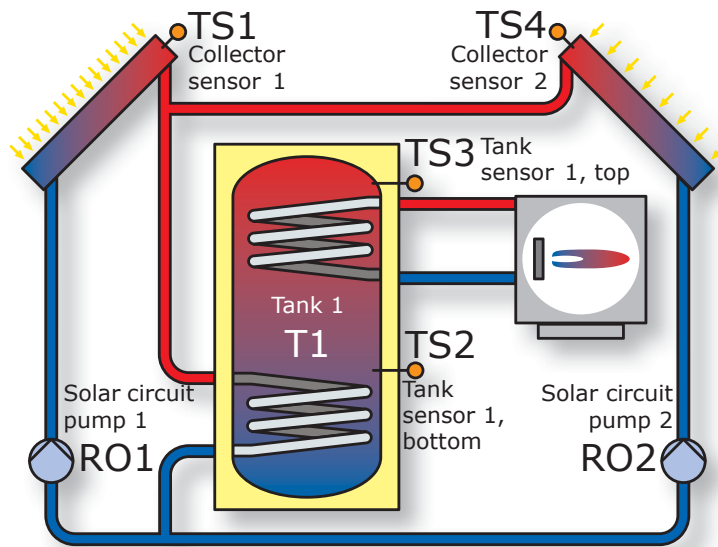

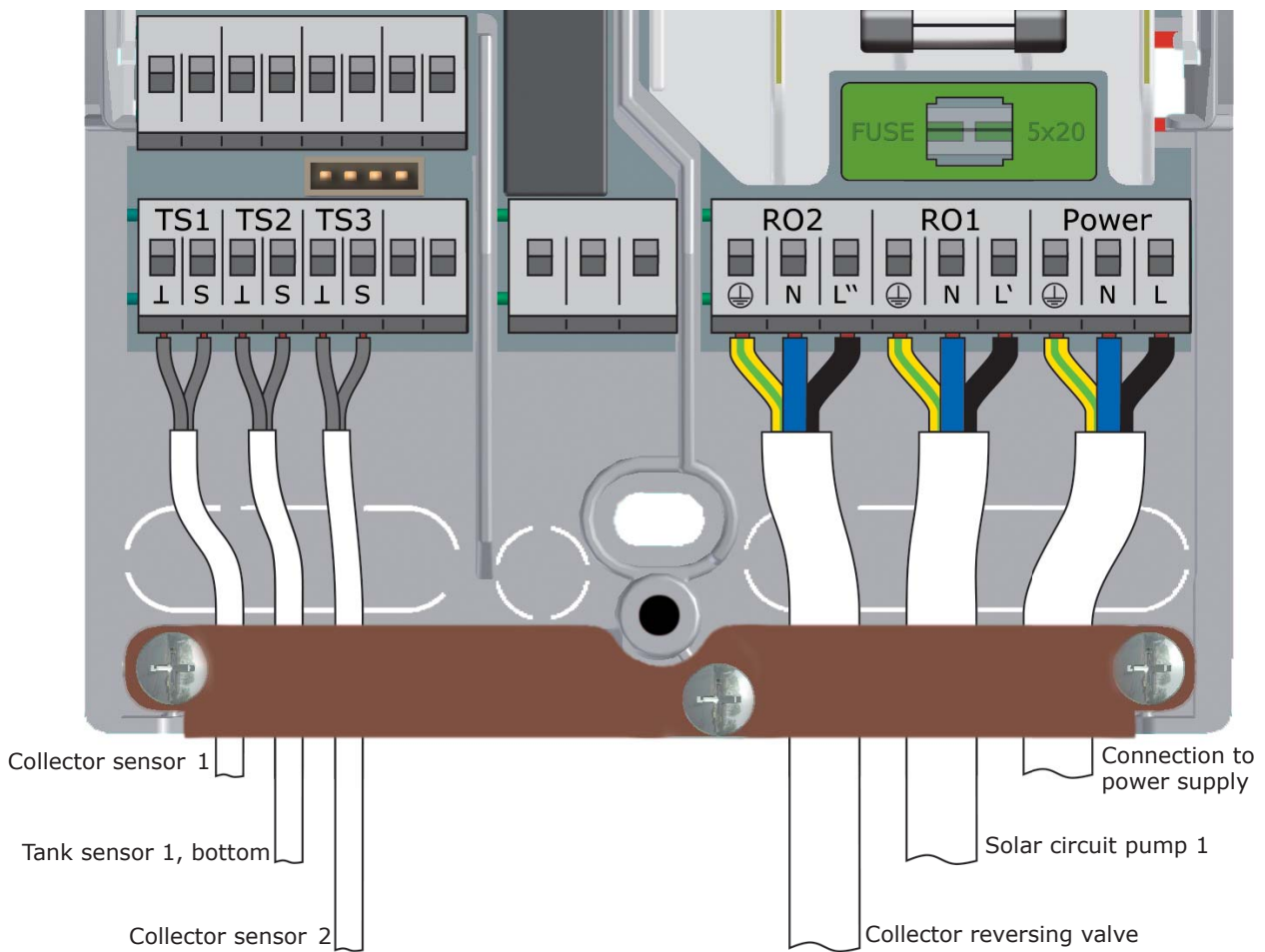
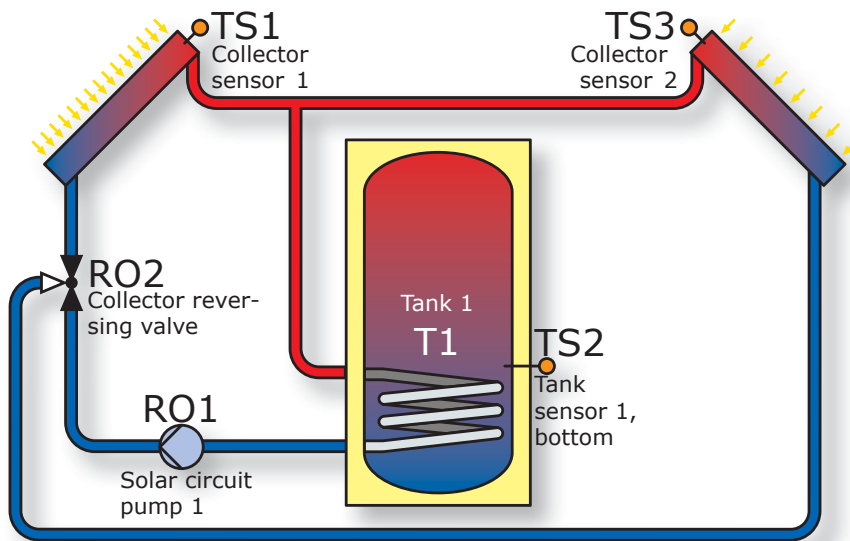

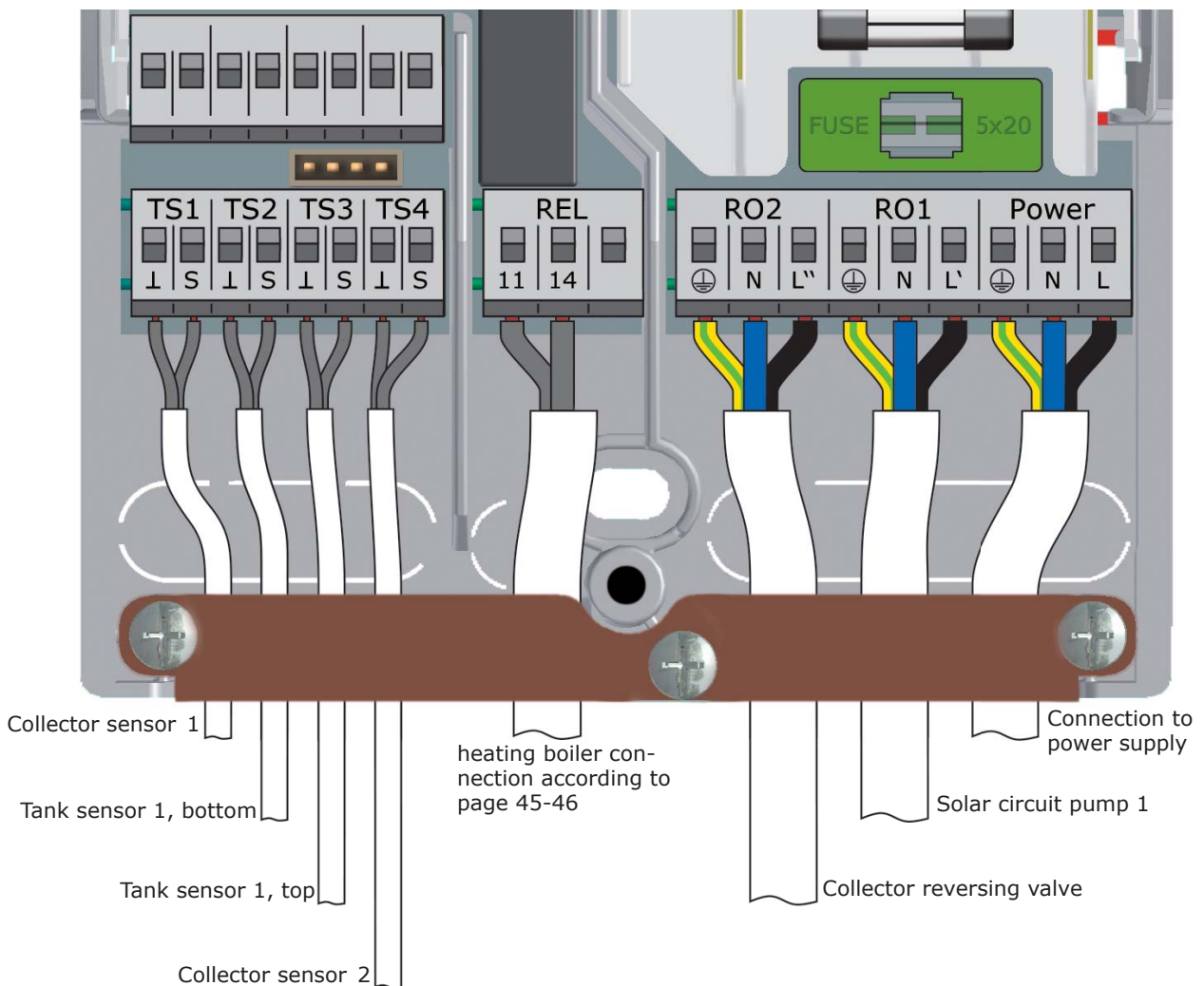
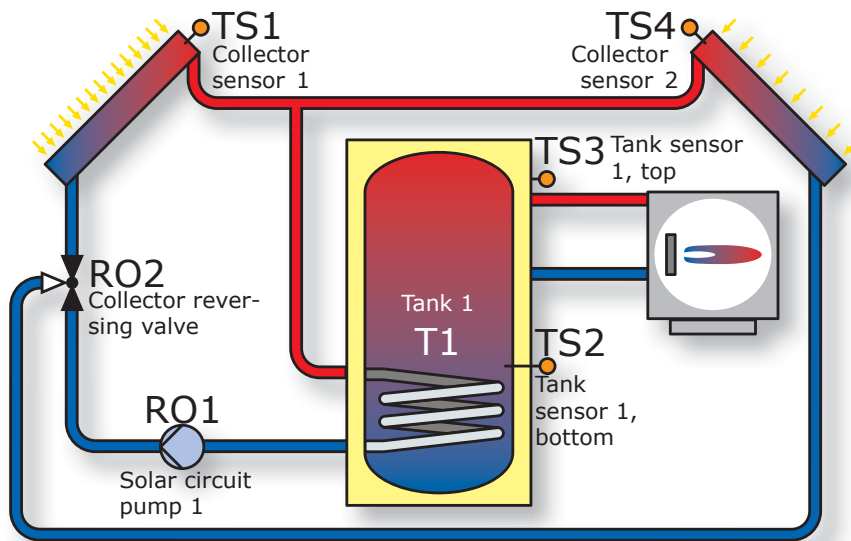

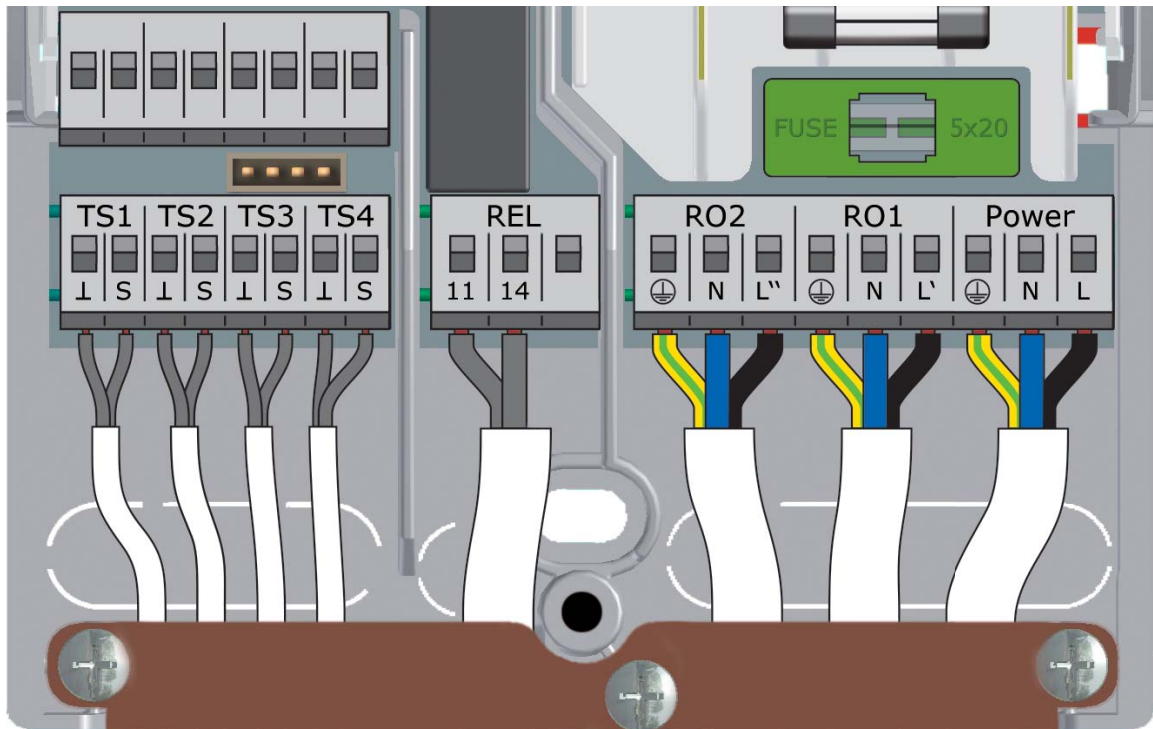
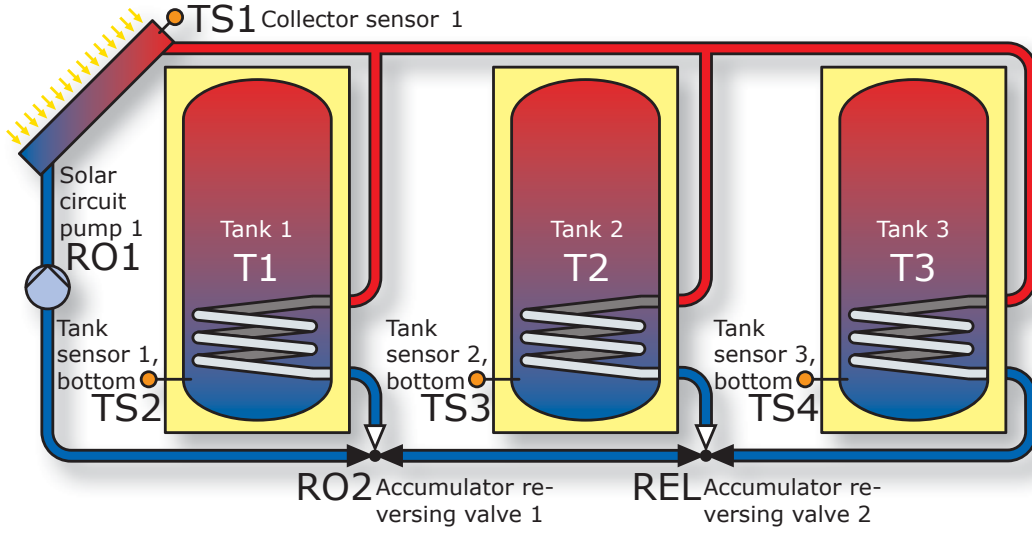

- Collector sensor 1
- Tank sensor 1, bottom
- Tank sensor 2, bottom
- Tank sensor 3, bottom
- Accumulator reversing valve 2
- Connection according to page 16
- Connection to power supply
- Solar circuit pump 1
- Accumulator reversing valve 1

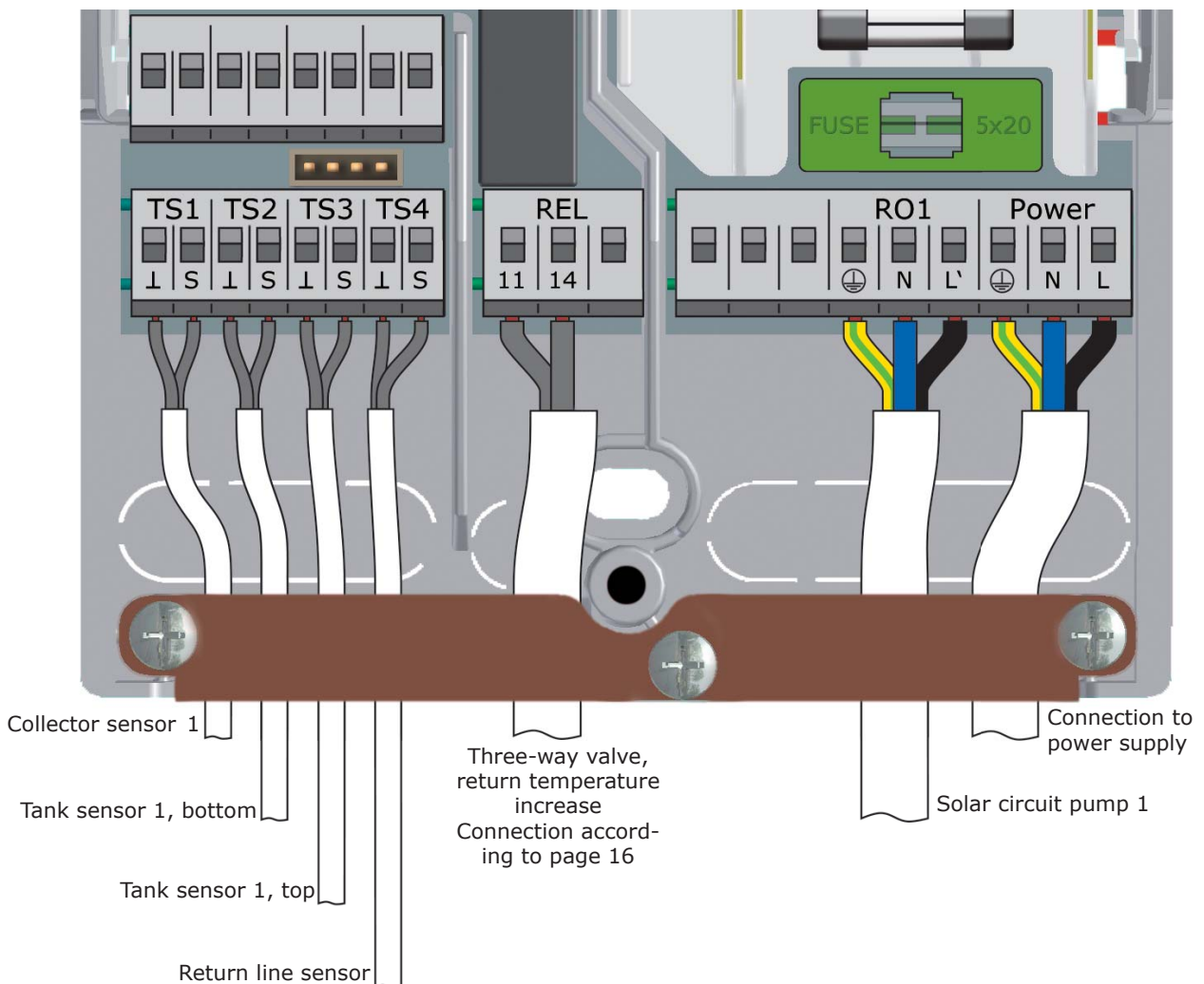
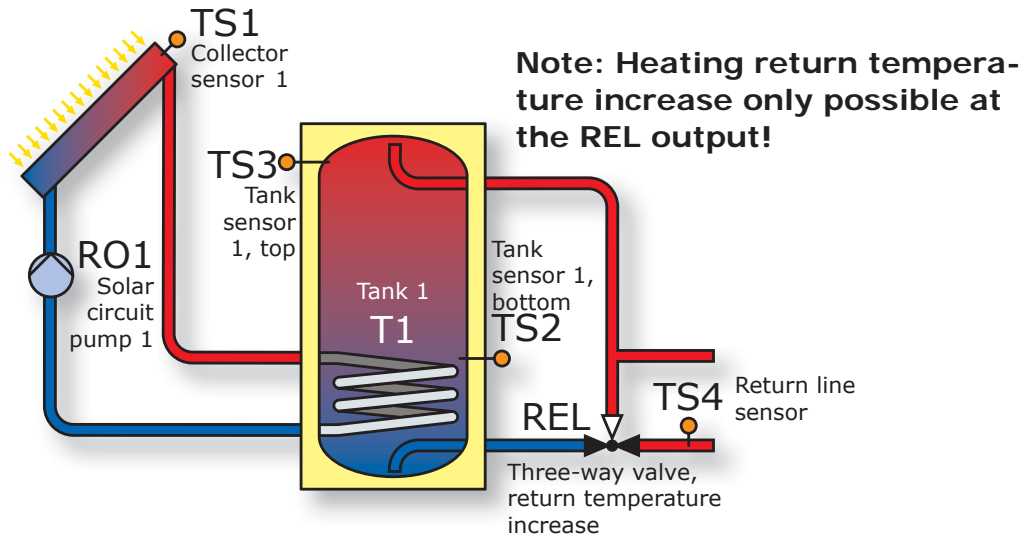

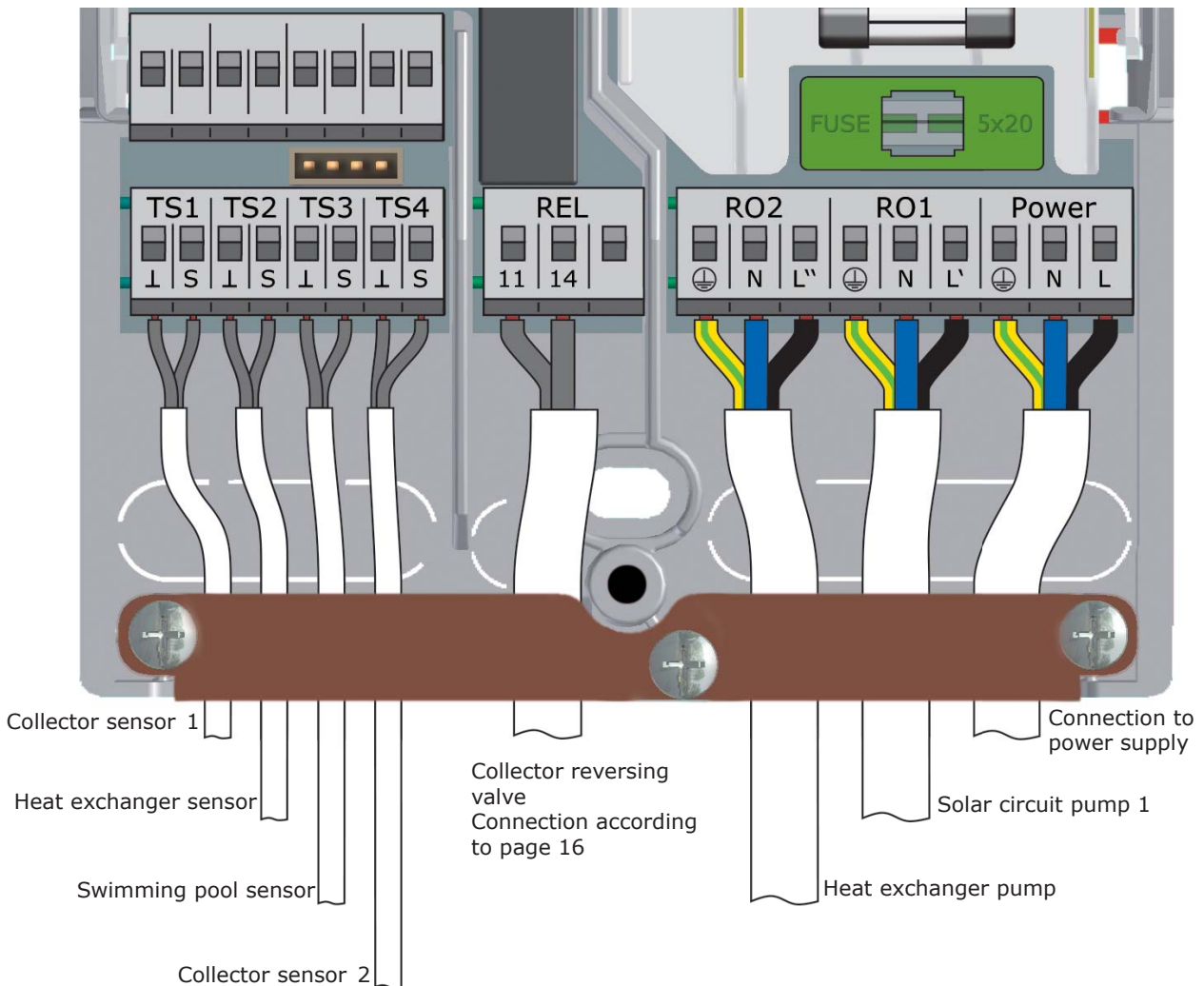
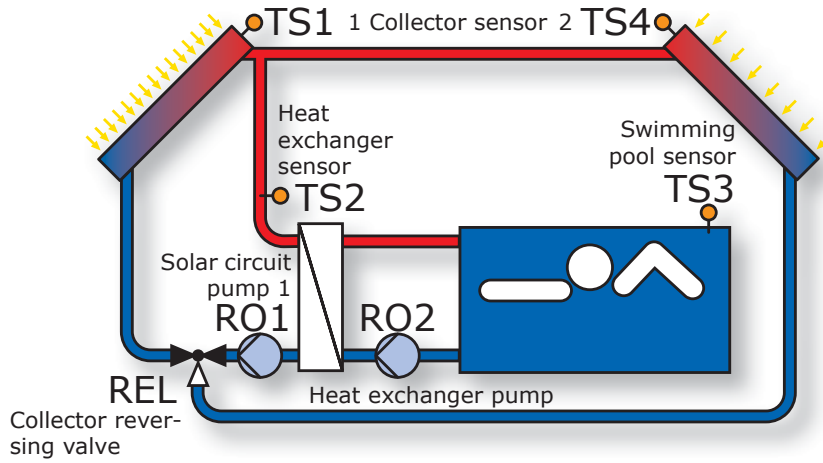

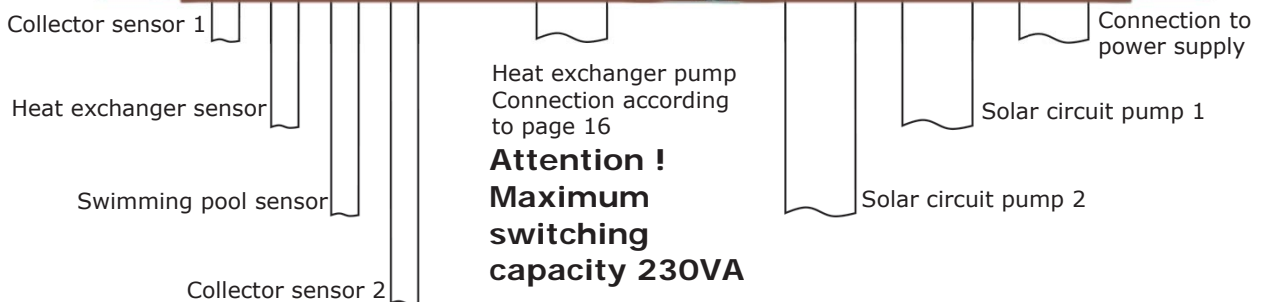
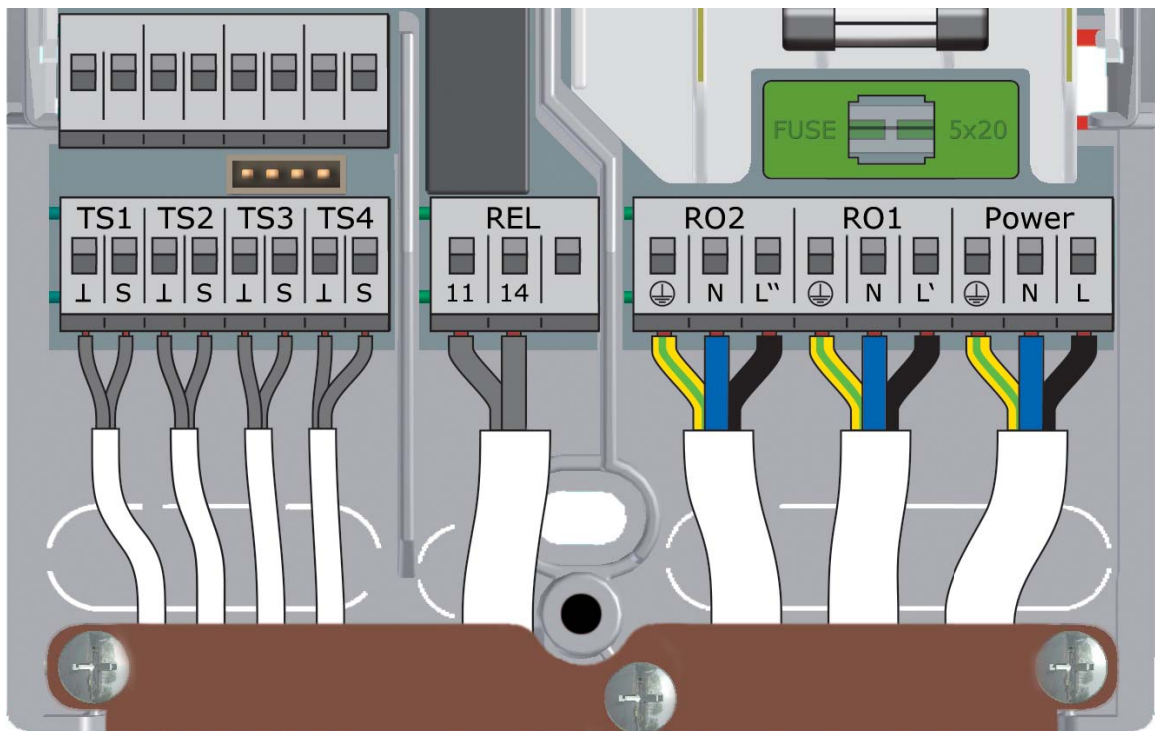
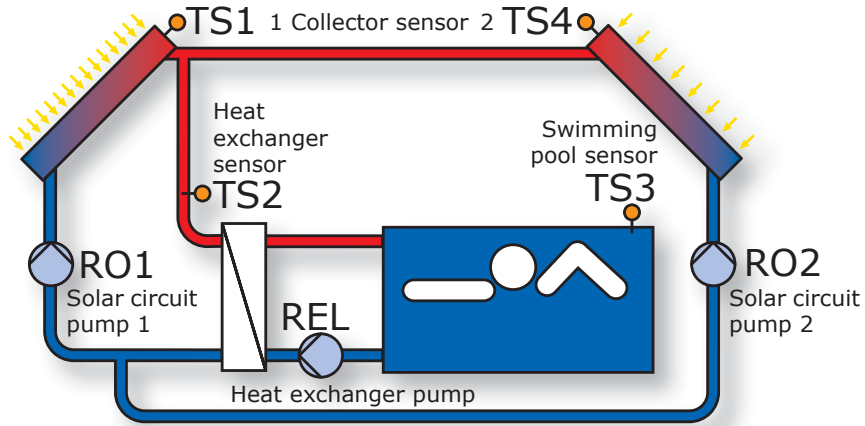

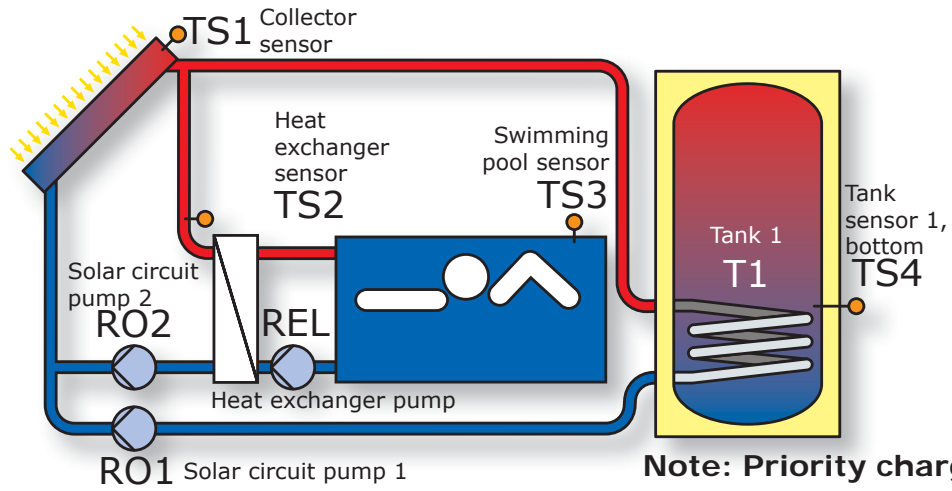

Note: Priority charging has been set to T1 in the factory.

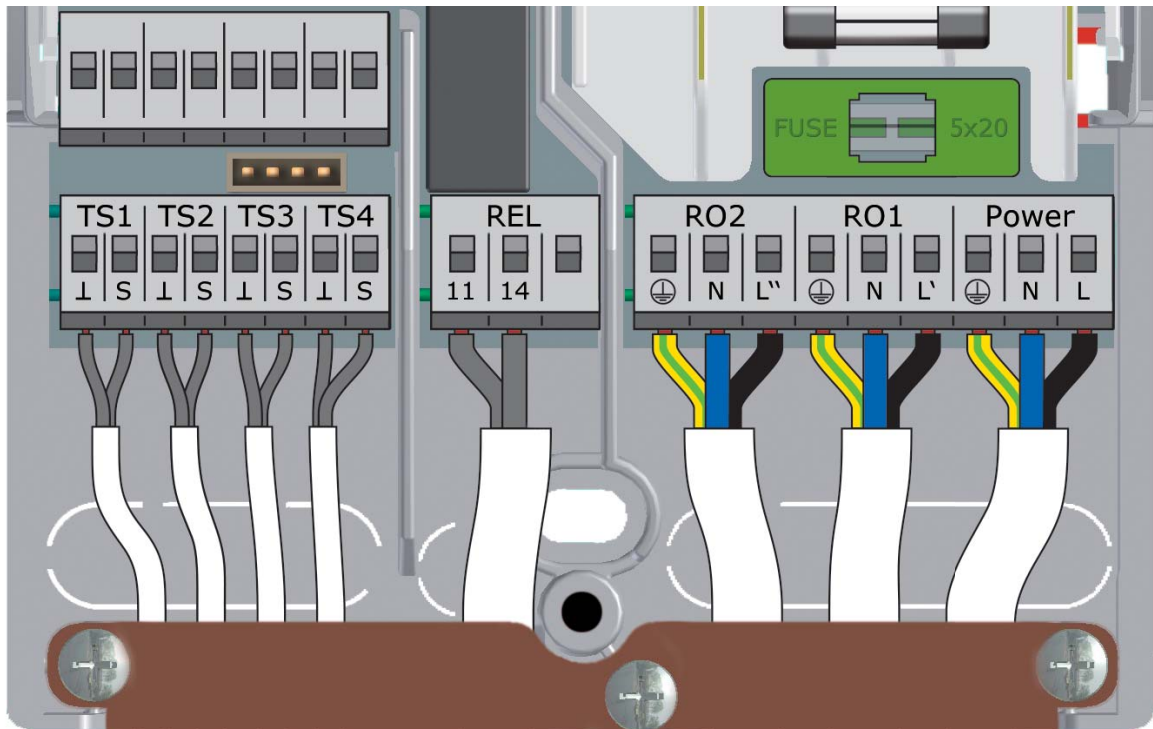

Collector sensor 1

Heat exchanger sensor

Swimming pool sensor

Tank sensor 1, bottom

Heat exchanger pump
Connection according to page 16

**Attention !
Maximum switching capacity 230VA**

Connection to power supply

Solar circuit pump 1

Solar circuit pump 2

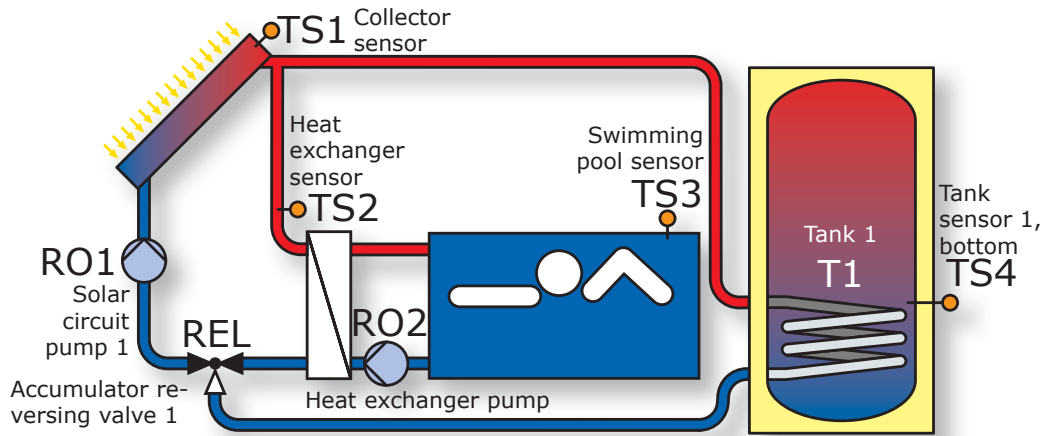

Note: Priority charging has been set to T1 in the factory.

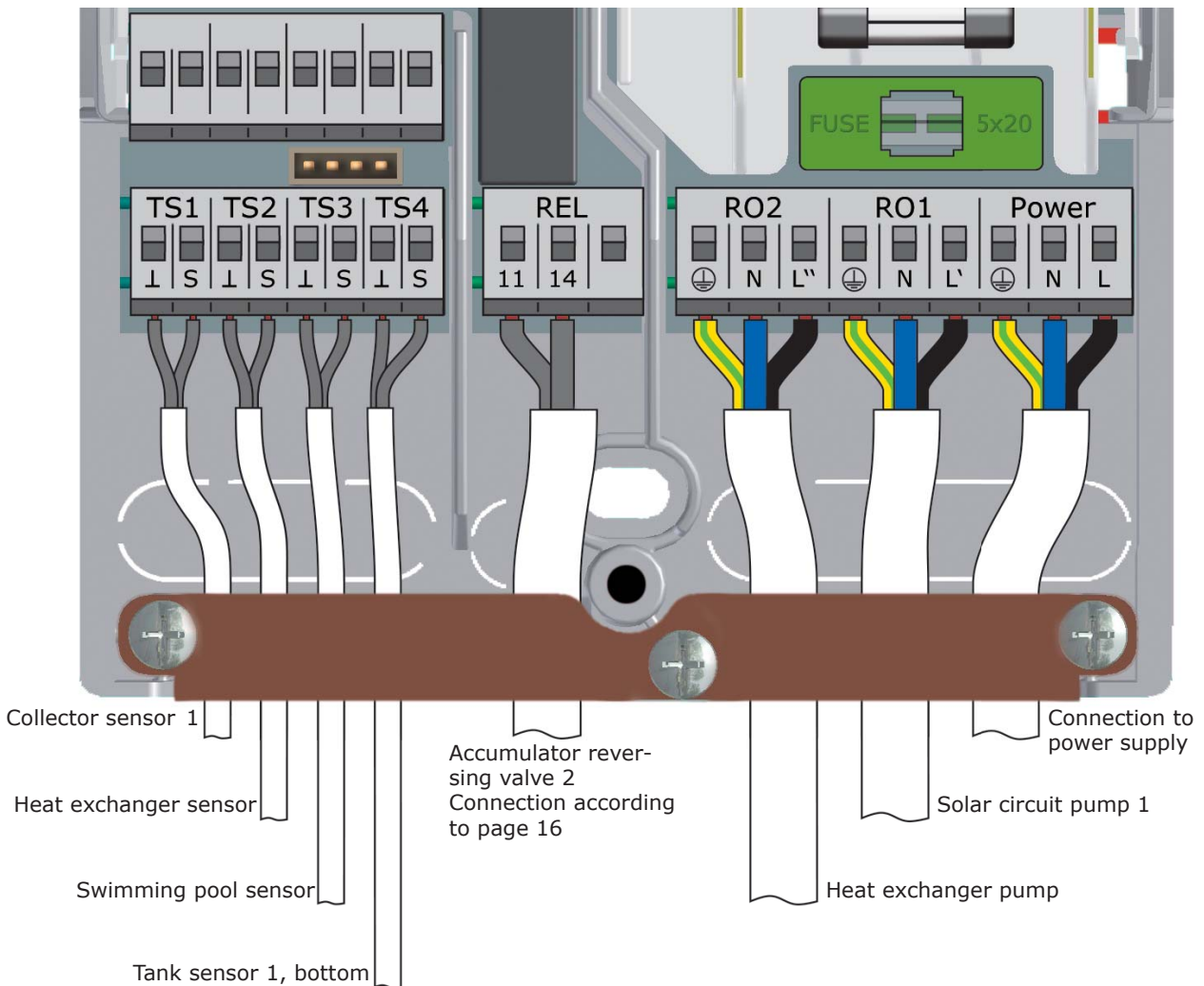

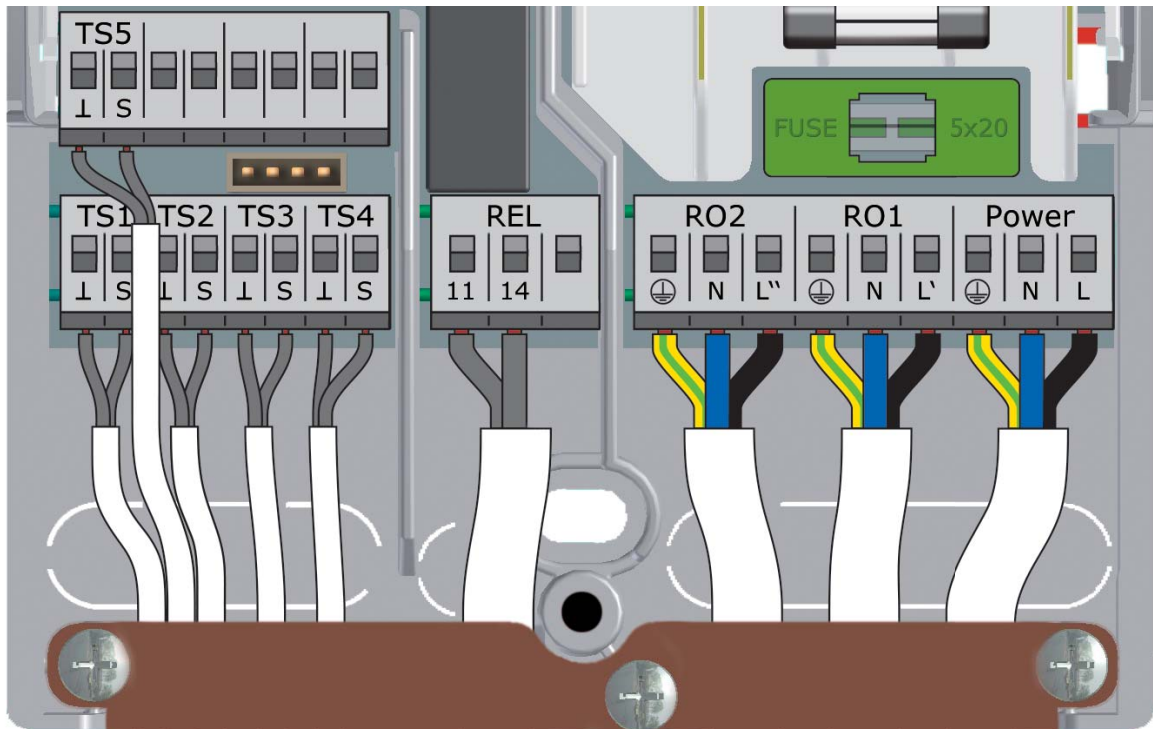
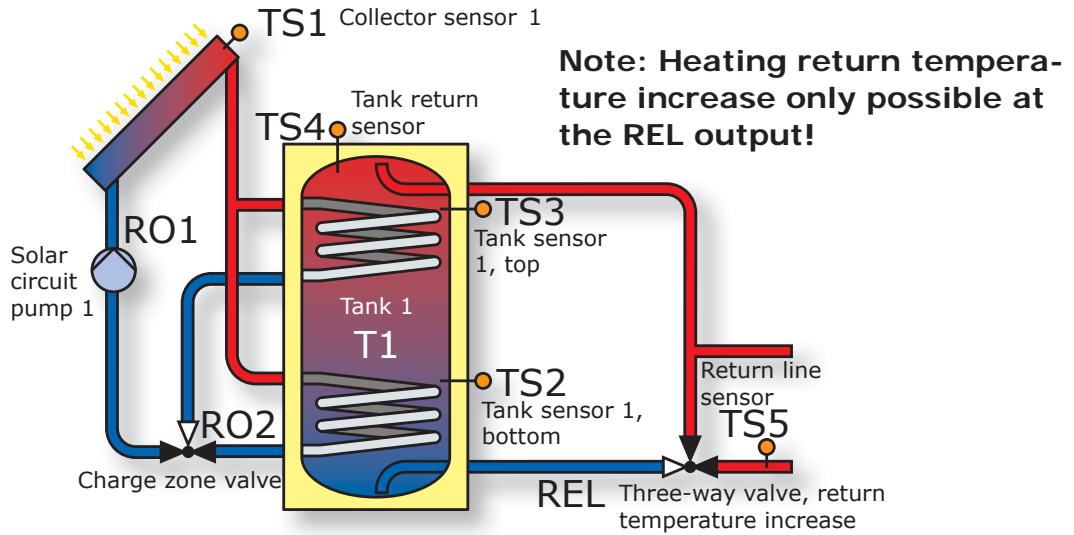

- Collector sensor 1
- Return line sensor
- Tank sensor 1, bottom
- Tank sensor 1, top
- Tank sensor return line
- Three-way valve, return temperature increase. Connection according to page 16
- Charging area valve
- Solar circuit pump 1
- Connection to power supply

The functions for boiler control are accomplished via the potential-free relay contact which is connected accordingly to the relevant interface of the heating boiler.

The individual functions are assigned the following priorities:

- A Anti-legionella priority 1
- B recharge suppression priority 2
- C reheating priority 3

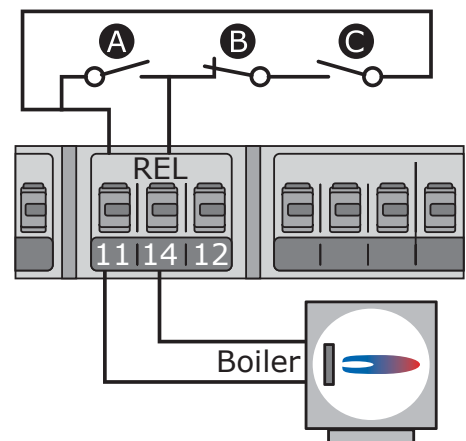

Anti-legionella function

The anti-legionella functions checks if the minimum heating for reduction of legionella has been achieved in the tank due to heating activity or solar heat within a set interval.

If no sufficient heating has been achieved by these means the controller starts a reheat cycle, specifically for reduction of legionella.

The fitter must set the parameters based on the applicable general directives and local requirements. The time of the disinfection cycle can be determined freely.

Reheat function

The temperature sensor in the upper tank area supplies the values for reheating.

For oil or gas operated systems, reheating takes place via the heating boiler.

For solid-fuel boilers, reheating takes place via the heat present in the drinking water tank. To this effect, the temperature within the tank must be within preset limits.

The temperature control is interlinked with six time blocks.

Reheating is activated as soon as the temperature falls below the set value by the hysteresis value in the current time block.

When the set value is exceeded the reheating cycle stops.

Note!

Symbols for the post heating function:

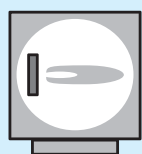

The post heating function of the controller was not activated in menu 1.3.10 and is generally not being performed.

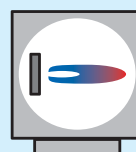
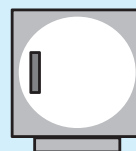

The post heating function of the controller was activated in menu 1.3.10, but is currently not being performed.

The post heating function of the controller was activated in menu 1.3.10 and is currently being performed.



Disable recharge

The efficiency of a solar plant increases as the recharge of the tank from the boiler decreases. Consequently, „disable recharge“ means that recharging of the water tank is blocked by the boiler.

Recharge suppression during solar yield

The recharge function of the heating boiler is suppressed while a solar circuit pump is operating.

Time-controlled disable recharge

Recharge is blocked by the boiler for specific phases via a time program. Within the preset period of time (for ex. 7 to 19 h), recharge is blocked completely by the boiler without requiring the minimum temperature to this effect.

Time-/temperature-controlled disable recharge

If a minimum temperature in the tank is exceeded, disable recharge is activated. This function can be activated in parallel to the time program. If the preset minimum temperature (e. g. 45°C) in the tank is exceeded, recharge of the tank is disabled by the boiler. If, however, the minimum temperature is no longer reached, recharge is enabled by the boiler no matter whether the time program blocks recharge or not.

Efficiency-optimized recharge suppression

If the calculated minimum temperature in the buffer tank is exceeded, the disabled recharge feature is activated. The minimum temperature is calculated on the basis of a weighting factor which is specified by the fitter in menu 1.4.3 by the „Emphasis“ parameter: „Emphasis“ can be set to „High comfort“, „Low comfort“, „Balanced“, „Low solar share“ or „High solar share“; it specifies the ratio of recharge (comfort) and solar yield.

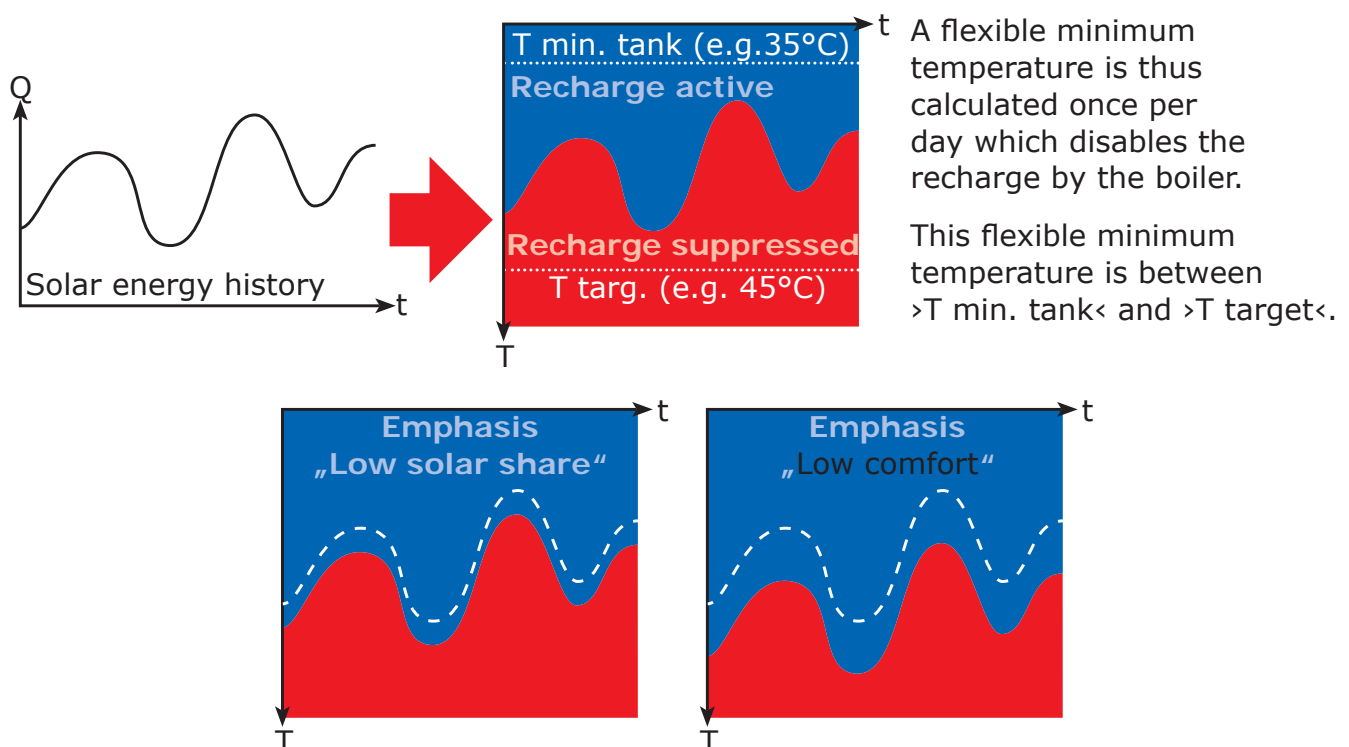



Note!

For boilers without control input, the functions for boiler control can be accessed by the simulation of temperature values.

To enable reheating or anti-legionella functions, the corresponding boiler temperature must be increased at the boiler control.



The differential temperature controller **smart Sol** regulates the boiler control functions by a fixed value resistance simulating a charged buffer tank for the boiler.

The resistance value depends on the type of sensor the heating is adjusted to - this information is provided in the boiler manual.

Sensor type	Pt 100	Pt 500	Pt 1000
R Terminal 12	130 Ω	620 Ω	1,3 kΩ
Colour code			

Connection provided at the REL terminal block, as illustrated.

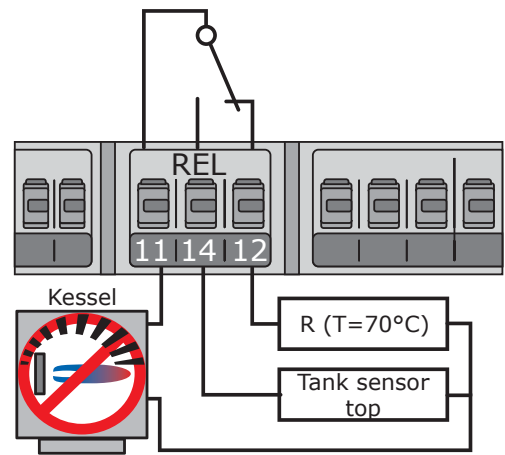

The controller's free outputs can be used as thermostats for various applications. Settings must be made to this effect in professional mode under >1.3.1 Thermostat<.

Control signals can be defined as temperature thermostat, timer, timer thermostat or temperature comparator.

Temperature thermostat >Heating<:
 $T_{OFF} > T_{ON}$ The output is deactivated once the > T_{OFF} < temperature is reached, and activated once the > T_{ON} < temperature is reached.

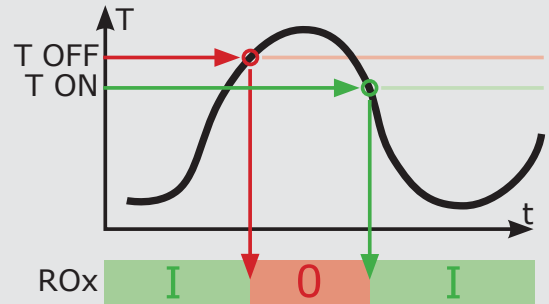

Temperature thermostat >Cooling<:
 $T_{ON} > T_{OFF}$ The output is activated once the > T_{ON} < temperature is reached, and deactivated once the > T_{OFF} < temperature is reached.

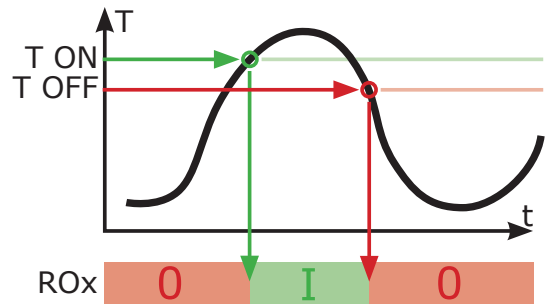

Timer function:
 The output is activated within a selected time frame.

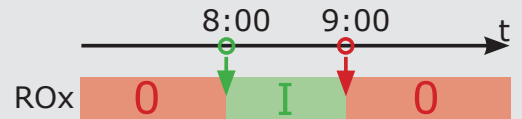

Timer-Thermostat
 Combination of timer and thermostat. Once at least one of these criteria is met, the output is activated.

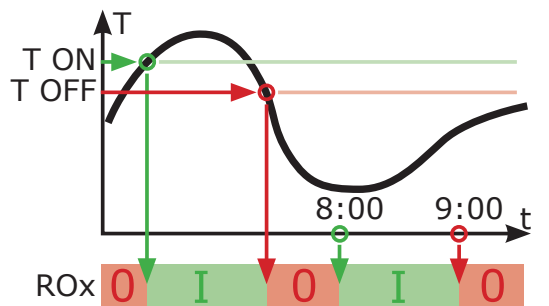

Temperature comparator
 Any temperature difference to a reference sensor will trigger a control signal: The output is activated once > dT_{ON} < is reached, and deactivated once > dT_{OFF} < is reached.

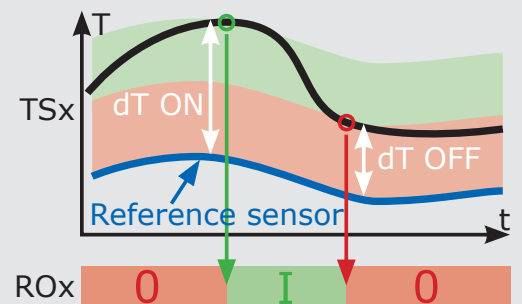



Important!

For commissioning, the controller must be assembled correctly, all inputs and outputs must be connected and ready for operation, the strain relief device must be screw-fastened and the terminal cover closed!



This is an explanation in terms of an example of commissioning of the differential temperature controller **smart Sol**; details vary along with the hydraulic configuration and the software version.

Commissioning is communicated in plain text; the user must make a selection, acknowledge and - if applicable - jump to the next menu item.

The differential temperature controller **smart Sol** accompanies you during the entire configuration and interrogates everything it must know for optimum operation.

Now, the power supply of the controller must be switched on - the display screen appears.

For repeat commissioning, the fitter must activate the professional mode using the access code (365).

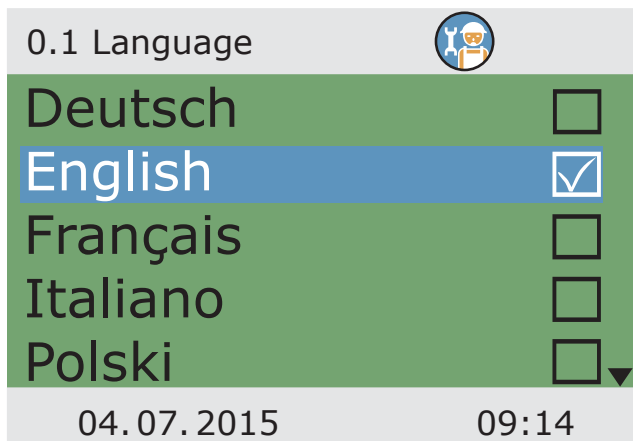

>0.1 Language< appears after a short booting sequence.

Various languages are available in this version of the **smart Sol**.

Activate the required version and acknowledge by pressing >Next<.

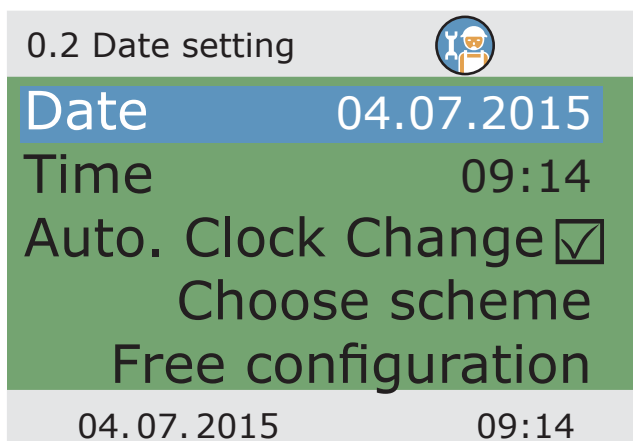

>0.2 Time/date< appears.

Press „OK“ -> the first value is highlighted.

Turn the rotary encoder until the correct value is displayed and acknowledge with „OK“.

Enter all values in this way.

At any place of installation where European daylight saving time is applicable, the automatic time difference is activated here.

Select „Choose system“ or „Free configuration“ and acknowledge with „OK“ - further information is provided on the next pages.

If there is an SD card with already saved configurations in the device, the menu item „Choose file“ appears at the end.

Select „Choose File“ and acknowledge with „OK“.

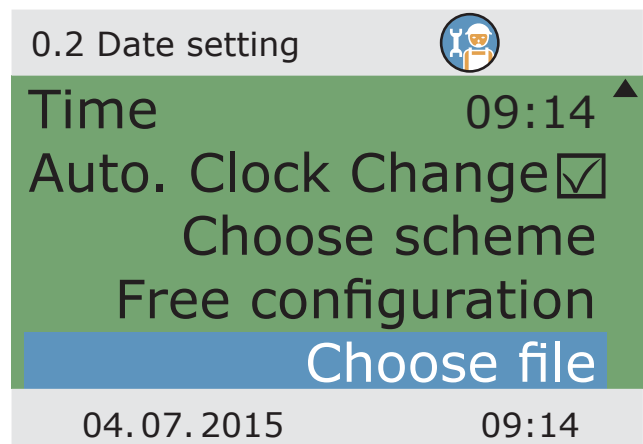

A list of pre-configured plant settings is displayed. Select the desired file and acknowledge with „OK“.

The configuration is loaded and the settings are applied in the following commissioning.

The files are on the SD card in the „PARAMS“ folder. It is possible to change the file names on the PC: Max. 8 characters, only letters and figures. Do not change the file extension!

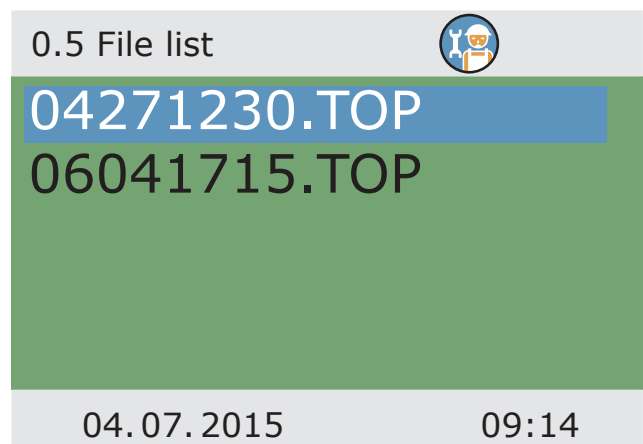

The plant configuration can be saved on the SD card during professional mode operation in the menu „1.2 Settings“ by selecting the menu item „Save parameter“.

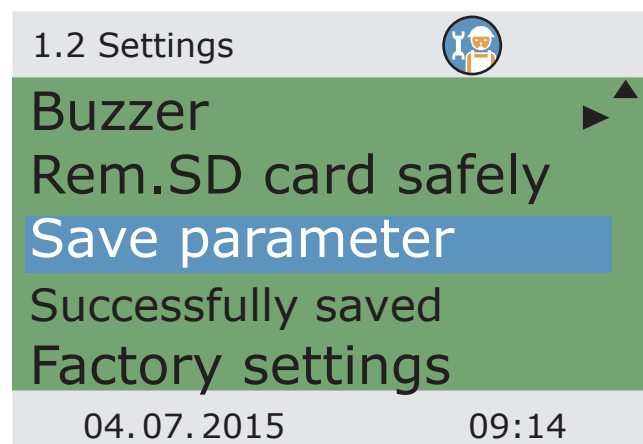

System 1

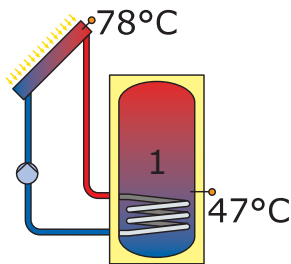

04.07.2015

09:14

If you select „Choose system“, the graphic illustration of a hydraulic system is shown.

Scroll through all available schemes using the rotary encoder, select the illustrated scheme by pressing the „OK“ button.

Then, any parameters relevant for the selected scheme are queried.

The process when selecting „Free configuration“ is in reverse order: first, outputs and inputs are allocated, then the controller offers the corresponding schemes for selection.



Note!

Below is a description of the commissioning process on the basis of free configuration. Free configuration should primarily be used for follow-up commissioning which is similar or almost similar to the previous configuration.



0.3 Outputs



RO1
RO2
REL

Solar pump 1

Next

04.07.2015

09:15

>0.5 Outputs< appears.

Select and activate the output interfaces RO1, RO2, REL used and assign them to the selected function by scrolling.

The following assignment of outputs is offered: Solar pump 1 / Solar pump 2 / Heat exchanger p / Transfer pump / Bypass valve v / Charge zone v / Tank ch.-over v 1 / Tank ch.-over v 2 / Coll ch.-over / Boiler

Some other output assignments offer further options: e.g. pumps may be specified as high-efficiency pumps.

Specific options can be selected for individual assignments.

0.3 Outputs 

RO1	Heat exchanger p	
HE control signal		---
Runs with solar pump		<input checked="" type="checkbox"/>
RO2		---
REL		---

04.07.2015 09:16

Assign one of the TS interfaces as „HE control signal“ ...

0.3 Outputs 

RO1	Solar pump 1	
HE control signal		TS4
RO2		---
REL		---
		Next

04.07.2015 09:15

... and specify the type.

0.3 Outputs 

RO1	Solar pump 1	
HE control signal		TS4
Type		---
RO2		---
REL		---

04.07.2015 09:16

0.3 Outputs 	
RO1	Solar pump 1
HE control signal	TS4
Type	Solar pump - Analog
RO2	---
REL	---
04.07.2015 09:17	

The HE control signal is specified as: analogue solar pump / PWM solar pump / analogue heating pump / PWM heating pump / Wilo ST25/7 PWM.

Once all outputs have been correctly assigned, acknowledge with „Continue“.

0.4 Inputs 	
TS1	59,6°C
	Coll 1
TS2	45,8°C

TS3	52,8°C
04.07.2015 09:18	

„0.4 Inputs“ appears.

Select and activate the input interfaces used and assign the selected assignment by scrolling. Inputs are specified as:

Coll 1 / Coll 2 / Tank 1 bot / Tank 2 bot / Tank 3 bot / Tank 1 top / Tank 2 top / Tank 3 top / Incr return T. / tank return / Swimming pool / Heat exch. / Bypass

0.4 Inputs 	

TS3	52,8°C

TS4	---
	Solar pump - Analog
04.07.2015 09:19	

Pre-assigned interfaces and their functions are displayed.

Continue with „Sensors“ once all assigned inputs have been allocated.

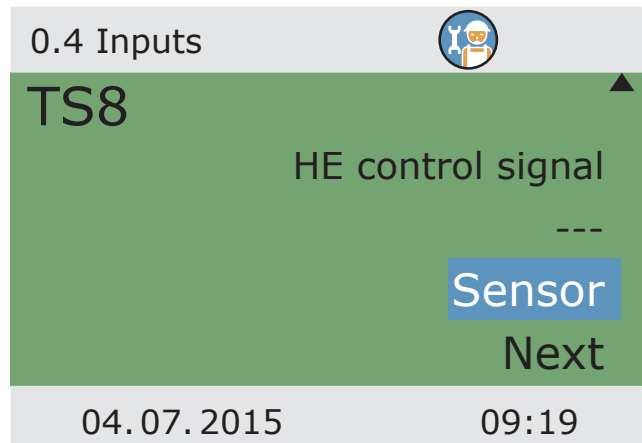

If the volume flow is measured with an impeller, „Impeller 1“ must be selected.

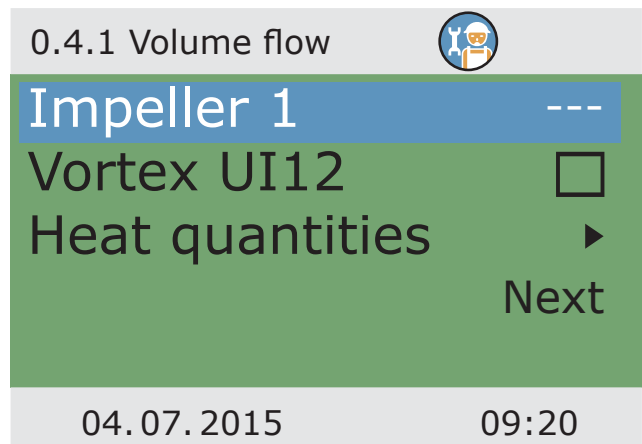

Assign the appropriate interface and then ...

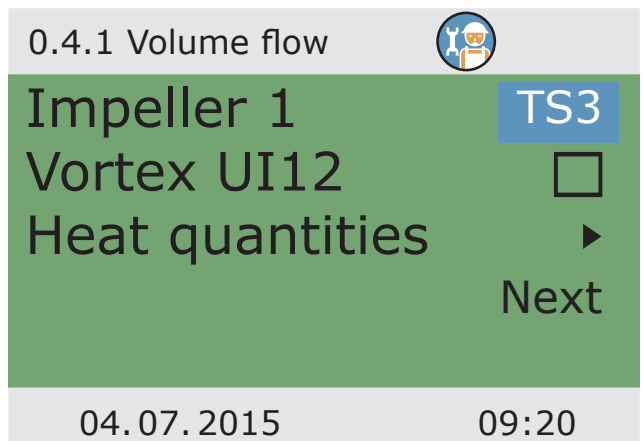

0.4.1 Volume flow 

Impeller 1 TS3

Unit Imp/l

Pulses/litre 1Imp/l

connected to RO1

04.07.2015 09:20

... specify the unit as Imp/l or l/Imp as well as the corresponding factor with 1 to 100 Imp/l or 0.1 to 10.0 l/Imp. Select the corresponding output.

Continue to scroll.

0.4.1 Volume flow 

connected to RO1 ▲

Vortex UI12

Heat quantities ▶

Next

04.07.2015 09:21

The Vortex sensors for the input of volume flow are selected here.

0.4.1 Volume flow 

Vortex UI12 ▲

flow rate

Grundfos 1-20l/min

connected to ---

04.07.2015 09:21

The following variables are provided for volume flow: Grundfos 1-12l/min / Grundfos 1-20l/min / Grundfos 2-40l/min / Grundfos 5-100l/min / Grundfos 10-200l/min / Grundfos 20-400l/min

Select the corresponding output.

Select „Heat quantities“.

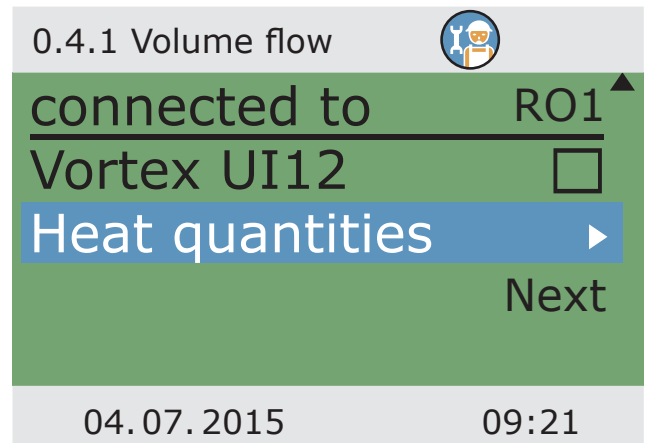

Select a heat quantity counter.

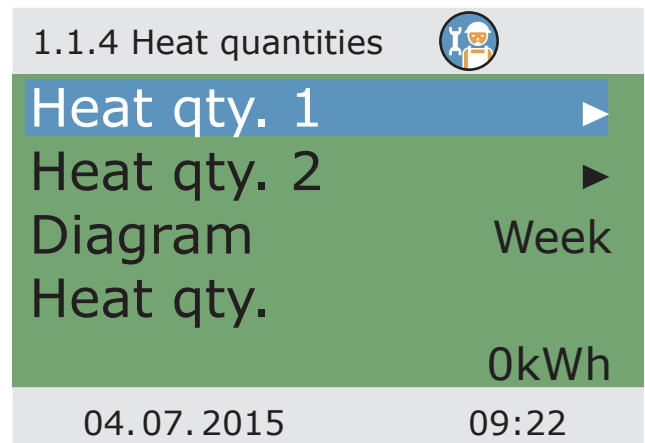

After activation, the volume flow sensor as well as ...

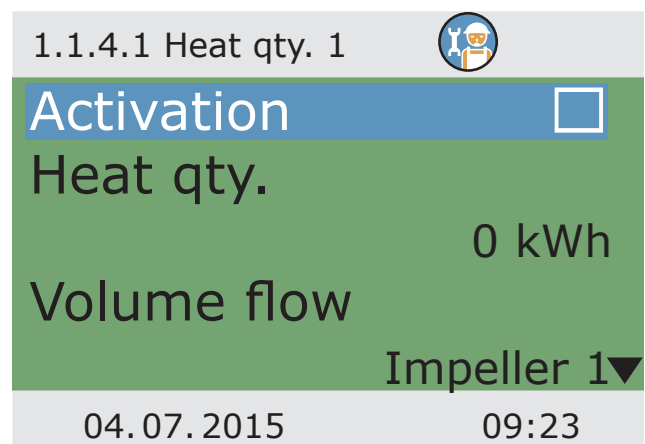

1.1.4.1 Heat qty. 1 

Ret.line sens. --- ▲

Supp.line sens. ---

Glycol type

Water

04.07.2015 09:23

the return line sensor and the supply line sensor must be specified.

Specify the heat exchanger medium: water / propylene glycol / ethylene glycol / Tyfocor / as antifreeze protection.

1.1.4.1 Heat qty. 1 

Glycol portion 20Vol% ▲

Delay 5s

Eff-tank-charge

Add to overall HQ

04.07.2015 09:23

Specify the portion of antifreeze in the exchanger medium as well as the delay.

Activate the effective tank charge, if necessary, and add the heat quantity data to the heat quantity counter.

Return by pressing the „esc“ key.

1.1.4 Heat quantities 

Heat qty. 2 ▲

Diagram Week

Heat qty. 0kWh

Reset

04.07.2015 09:23

The energy measured by the heat quantity counter is displayed in kWh or illustrated in a diagram.

The illustration includes „Week“, „Month“ or „Year“.

By pressing the „Reset“ button, the heat quantity counter is reset to 0.

Display of the diagram
 Return by pressing the „esc“ key.

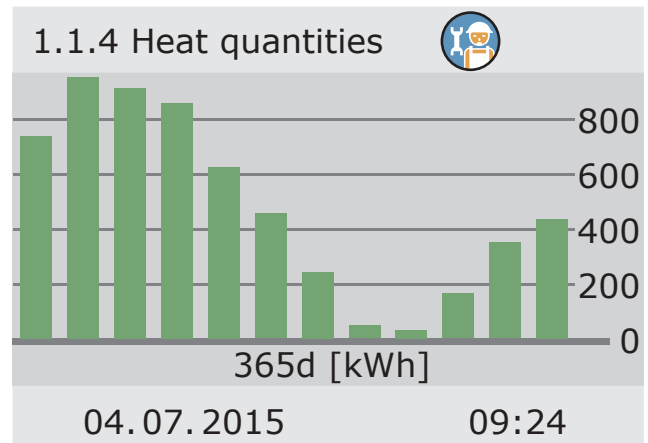

„0.4 Inputs“ is displayed again.
 Acknowledge your input by pressing „Next“.

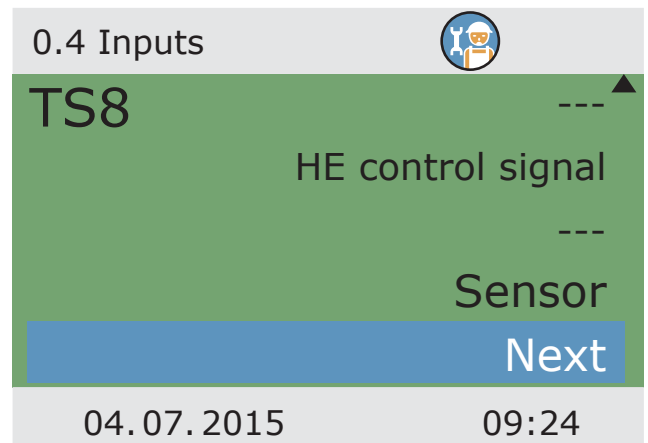

All hydraulic schemes which are possible due to your input are displayed.
 Make your selection by scrolling with the rotary encoder and acknowledge with „OK“.

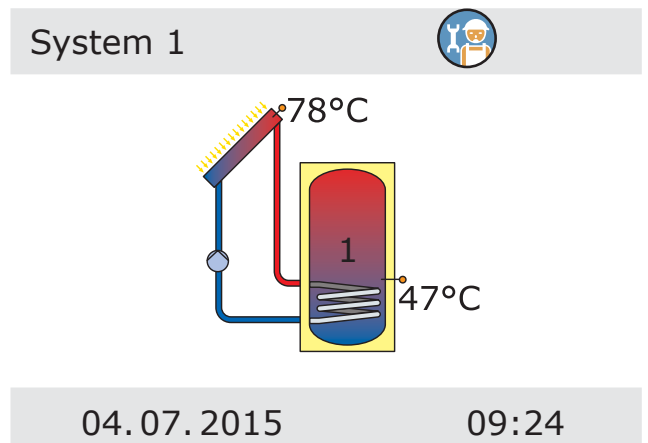

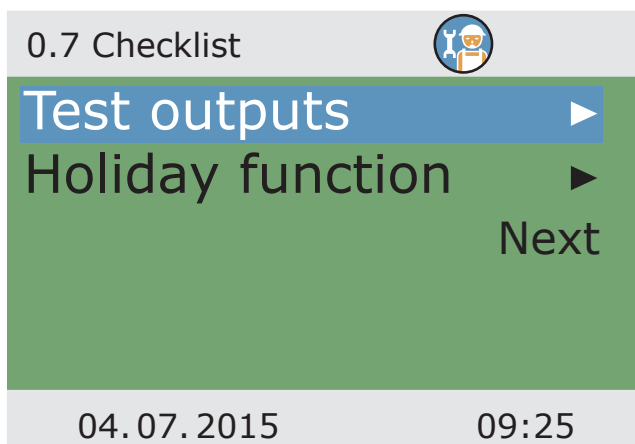

„0.7 Checklist“ appears.

Check the function by selecting „Test outputs“.

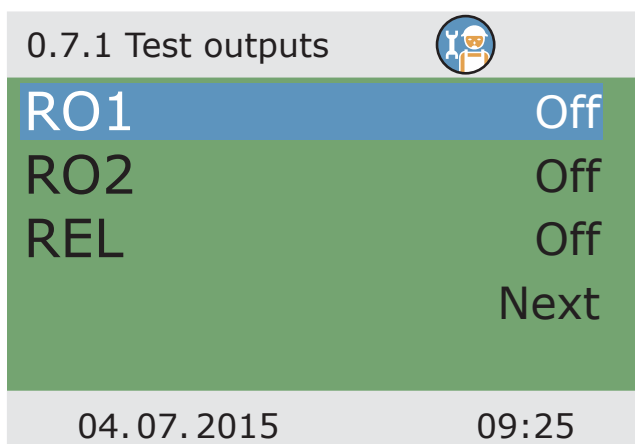

„0.7.1 Test outputs“ appears.

Select output, activate with „OK“, select „On“ on the rotary encoder and activate it with „OK“. The connected pump and/or the connected valve must now be activated.

Complete the test operation by pressing „Next“.

Note!

If the hydraulic installation does not comply with the standard, or if special products were used which cause incorrect valve positions during test operation, the „Inverted“ option must be activated by accessing the corresponding output menu 1.3.7 in professional mode after commissioning. The controller will then exchange energized and de-energized conditions.



Select the „Holiday function“.

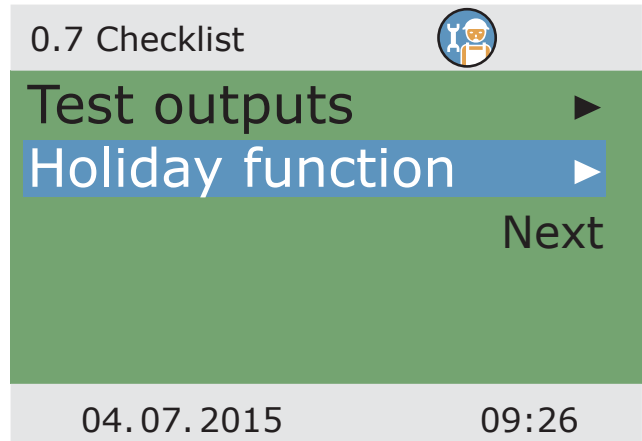

Various options can be selected for the holiday function.

At lower ambient temperatures (e. g. at night), tank recooling tries to dissipate heat via the collectors.

The soft charge circuit is designed so that the heat input into the tank is as low as possible.

The appropriate switch-ON and OFF temperatures must be varied as required.

Acknowledge by pressing >Next<.

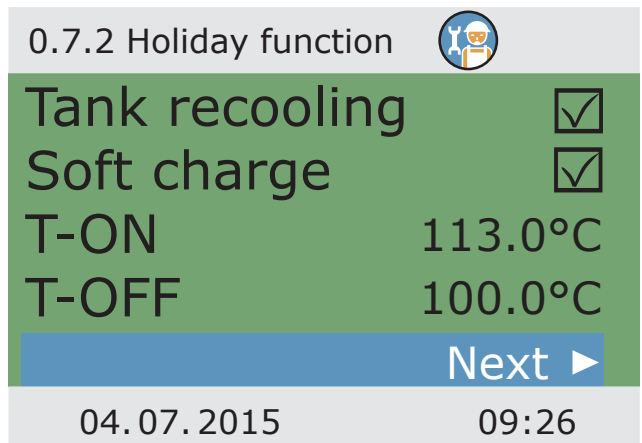

Complete the checklist by pressing „Next“.

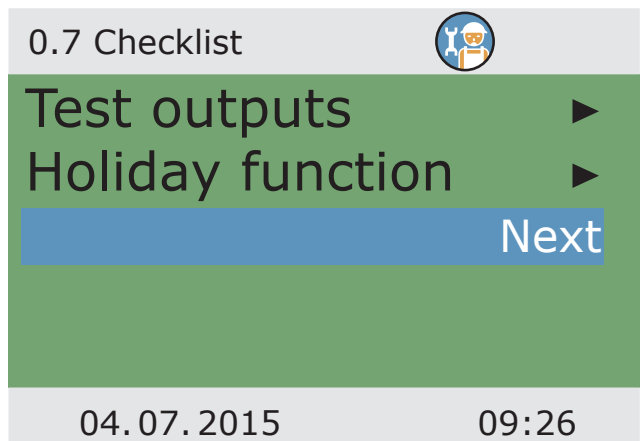

0.8 Parameter 

T limit 1	60.0°C
T max.tank 1	59.0°C
T limit 2	60.0°C
T max.tank 2	59.0°C
If T-limit > 60°, anti-scalding	▼

04.07.2015 09:27

„0.8 Parameter“ appears

Setting the limit temperatures:

The tanks are only loaded until the maximum temperature „T max. tank“ has been reached.

In case of imminent collector overheating, the tanks are loaded to „T limit“.

If the temperature in a tank exceeds the „T limit“ value, the solar circuit pump is immediately turned off and not turned on until the temperature has fallen below the „T limit“ value.

0.8 Parameter 

protection must be installed. ▲

Antifreeze protect.	▶
Tube collector	▶
Post Heating Requ.	▶

Next

04.07.2015 09:27

Selecting „antifreeze protection“.

Note!

The antifreeze protection function of the controller may prevent the heating system from damage which could be caused by freezing medium. To this end, enter the lowest temperature „T ON“ at which a system filled with pure water without antifreeze could operate without suffering damage.

If antifreeze is used, the controller will calculate the adjusted antifreeze protection temperature from the entered values for type and portion displaying it as „T ref“.



Activation and setting of the anti-freeze protective function for the collector.

Via >T ON<, enter the anti-freeze protection temperature for water-filled plants.

If anti-freeze products are used, the type can be defined as water, Tyfocor, propylene glycol or ethylene glycol, after scroll-down the proportion can be entered.

Press >esc< to return.

1.5.3 Antifreeze pr... 

Activation

T ref 5.0°C

T ON 5.0°C

Glycol type Water▼

04.07.2015 09:27

Select „Tube collector“ if the plant is equipped with vacuum tube collectors.

0.8 Parameter 

protection must be installed. ▲

Antifreeze protect. ▶

Tube collector ▶

Post Heating Requ. ▶

Next

04.07.2015 09:28

To receive correct measured values from the tube collector system, the pump must be switched ON briefly.

By activation of the function, the solar circuit pump can be started time- and/or temperature-controlled.

The time sequence, the pump ON time and ...

1.3.2 Tube collector 

Activation

Start time-dependent

t-ON 10min

T ON 20.0°C

t solar 1 20s▼

04.07.2015 09:28

1.3.2 Tube collector 

n solar 1	100%
t solar 2	0s
n solar 2	30%
t start	06:00
t end	20:00
04.07.2015	09:28

... the pump delivery rate as a percentage value can be entered.

The two time programs are performed one after the other.

Continue via the menu item >Holiday function<.

Press >esc< to return.

0.8 Parameter 

protection must be installed.	▲
Antifreeze protect.	▶
Tube collector	▶
Post Heating Requ.	▶
Next	
04.07.2015	09:29

If a hydraulic scheme including boiler control functions has been selected, the post heating requirements are configured here.

Select „Post heating req.“.

1.3.10 Post Heatin... 

Activation	<input type="checkbox"/>
Boiler type	Solid fuel boiler
Hysteresis	10.0K
Min. temp.	40.0°C ▼
04.07.2015	09:29

Here, reheating can be activated.

The boiler is defined as >Solid-fuel boiler< or >Gas/oil<.

In case of solid-fuel boilers reheating is made via the charge pump of the drinking water tank and is only activated if the temperature of the tank is within the values >Min. temp.< and >Max. temp.<.

Use >Boiler sensor< to assign the temperature sensor which supplies the temperature value of the boiler.

Up to six time blocks can be activated for reheating.

1.3.10 Post Heatin... 

Max. temp. 55.0°C ▲

Sensor boiler TS4

Time block 1 ▶

Time block 2 ▶

Time block 3 ▶▼

04.07.2015 09:29

>Ref. temp.< is used to define the set temperature at the top tank sensor.

If the temperature falls below >Ref. temp.< by >Hysteresis<, the control activates the reheating cycle via the heating boiler until >Ref. temp.< is reached.

1.3.10 Time block 1 

Activation

Ref. temp. 45.0°C

Starting time 00:00

End time 23:59

04.07.2015 09:29

Each period can be defined with >Saturday<, >Sunday<, >Weekends<, Monday - Sunday< or >Monday - Friday<.

Return to the post heating requirements by pressing the „esc“ key.

1.3.10 Time block 1 

Ref. temp. 45.0°C ▲

Starting time 00:00

End time 23:59

Time period
Monday - Sunday

04.07.2015 09:29

0.9 End



You have completed
commissioning!

Next

04.07.2015

09:30

>0.8 Parameter< reappears.

Acknowledge by pressing >Next<.

>0.9 End< appears.

By >Next<, the controller
changes over to >Automatic mode<.

System 1

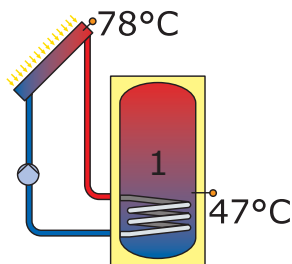

Commissioning is complete.

From now on, the solar thermal plant is controlled automatically.

04.07.2015

09:30

AUTOMATIC MODE

In automatic mode, the screen displays the date, the time and the active hydraulic system.

The current temperature is displayed for each temperature sensor.

Pump operation and valve position are illustrated on the animated display.

There is no need for intervention by the fitter or operator.

System 1

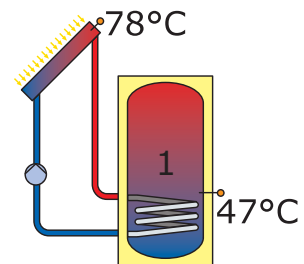

04.07.2015

09:30



Note!

Check the display screen of the **smart Sol** on a regular basis to be able to eliminate any malfunctions promptly!







Note!

The following illustration shows the structure of the control menu. The controller does not display any sub menus which are not required by either the selected scheme or by the activated options.

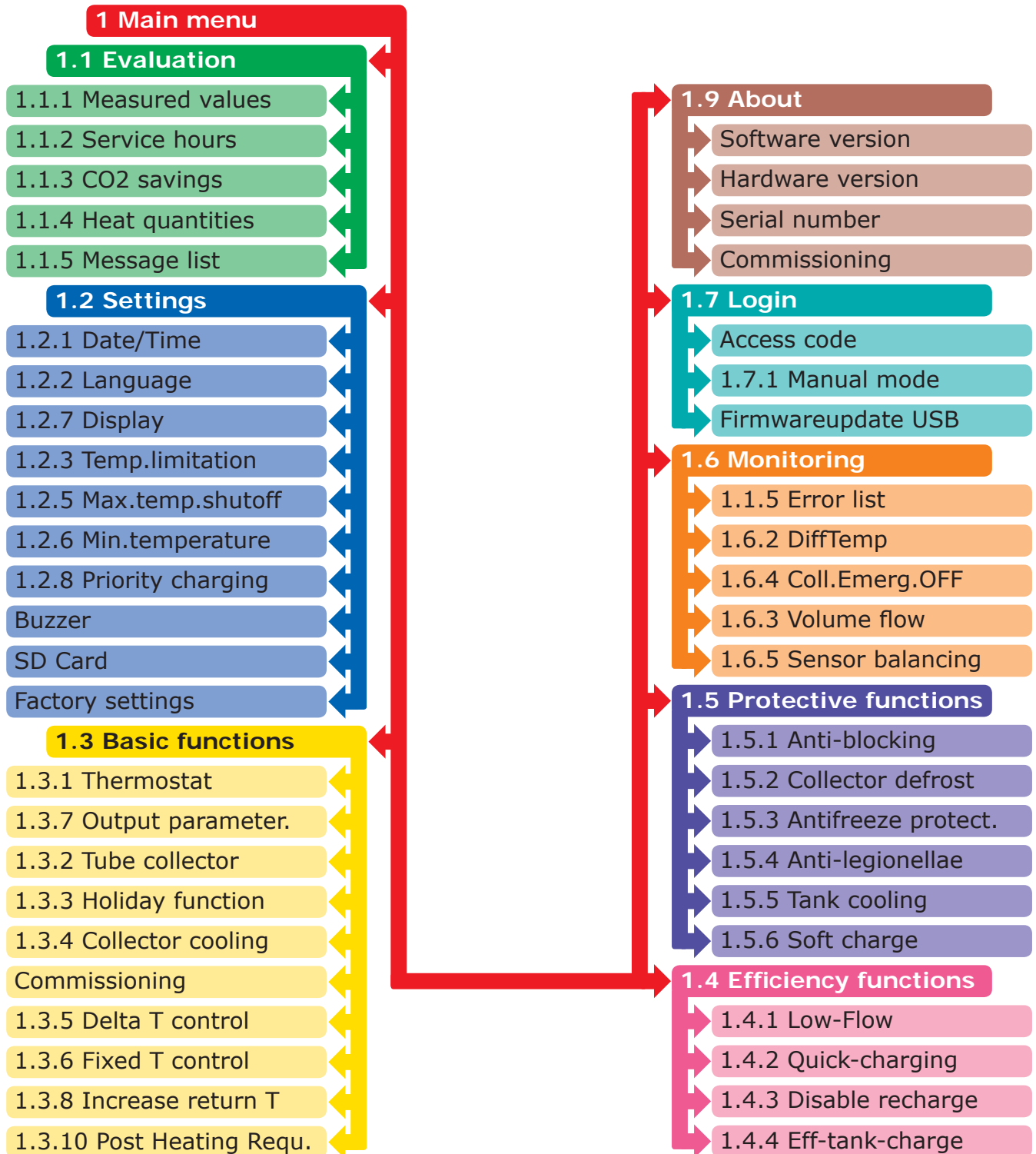

System 1

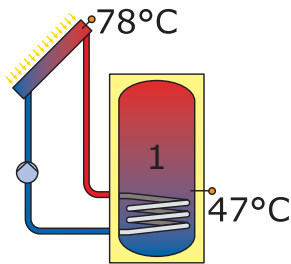

On the controller, the user can make various settings and obtain information about states and processes.

To this effect, press the button >OK< in automatic mode.

04.07.2015

10:19

1 Main Menu

- Evaluation ▶
- Settings ▶
- Basic functions ▶
- Efficiency functions ▶
- Protective funct. ▶▼

>1 Main menu< appears.

A list of subitems appears

By scrolling ...

04.07.2015

10:19

1 Main Menu

- Efficiency functions ▶▲
- Protective funct. ▶
- Monitoring ▶
- Login ▶
- Info ▶

...the lower part of the menu is displayed.

Once the first subitem >Evaluation< is selected, ...

04.07.2015

10:19

...>1.1 Evaluation< appears.
 Another selection level appears.
 Once the first subitem
 >Measured values< is selected, ...

1.1 Evaluation	
Measured values	▶
Service hours	▶
CO2 savings	▶
Heat quantities	▶
Message list	▶
04.07.2015	10:20

...>1.1.1 Measured val...< appears.
 Here, the temperatures and dates
 concerning the controller are displayed.
 If additional tank sensors have been defined
 on commissioning, these measurands also
 appear here.
 By scrolling ...

1.1.1 Measured val...	
Coll 1	78.2°C
Tank 1 bot.	47.0°C
Tank 2 bot.	42.1°C
Tank 2 top	61.4°C
Solar pump 1	80%▼
04.07.2015	10:20

...the lower part of the menu
 (if available) is displayed.
 Return to >1.1 Evaluation<.
 Once the second subitem
 >Service hours< is selected, ...

1.1.1 Measured val...	
Tank 2 bot.	42.1°C▲
Tank 2 top	61.4°C
Solar pump 1	80%
Solar pump 2	34%
Boiler	OFF
04.07.2015	10:20

1.1.2 Service hours

Solar pump 1	112h
Solar pump 2	94h
Reset	

04.07.2015

10:21

...>1.1.2 Service hours< appears.

The operating time of the activated plant components is displayed in hours.

By actuating the menu item >Reset<, all counters are reset to zero.

The values are saved once per day, so that one day max. is „lost“ in case of failure of the power supply.

Return to >1.1 Evaluation<.

Once the third subitem >CO2 savings< is selected, ...

1.1.3 CO2 savings

Activation	<input checked="" type="checkbox"/>
Savings	447 kg
Reset	
Fuel	Natural gas

04.07.2015

10:21

...>1.1.3 CO2 savings< appears.

Here, assessment of the saved carbon dioxide can be activated, read and reset.

By selecting >Fuel<...

Edit

Fuel	Natural gas
Restore last value	
Factory settings	

04.07.2015

10:22

...>Edit< appears.

Here, the fuel types natural gas or fuel oil can be selected for a calculation of CO₂.

Return to >1.1 Evaluation<.

Continue with >Heat quantities<.

>1.1.4 Heat quantities< appears.

Up to two heat counters can be configured for the collection of the generated energy quantity.

The evaluation period can be selected via the >Diagram< - >Week<, >Month< or >Year<

Press >Reset< to reset the counter to 0.

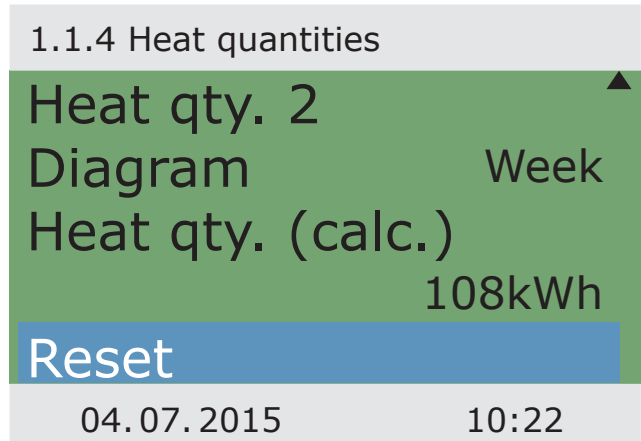

The evaluation appears as a bar graph.

Selecting a submenu, e.g. >Heat qty. 1<...

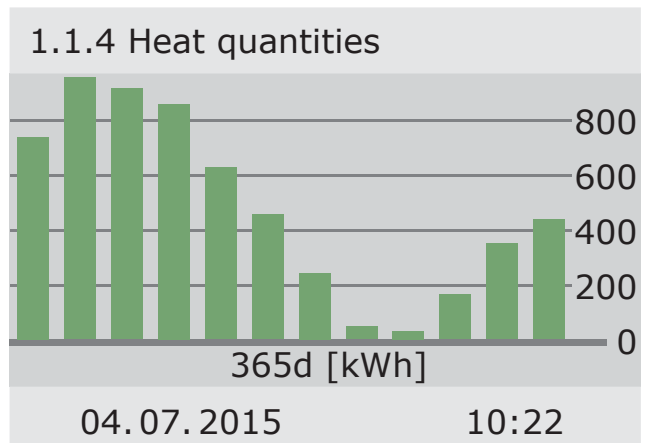

...will access >1.1.4.1 heat qty. 1<

Activation will start a counter which calculates heat yield.

>Volume flow< defines the volume flow sensor to be used.

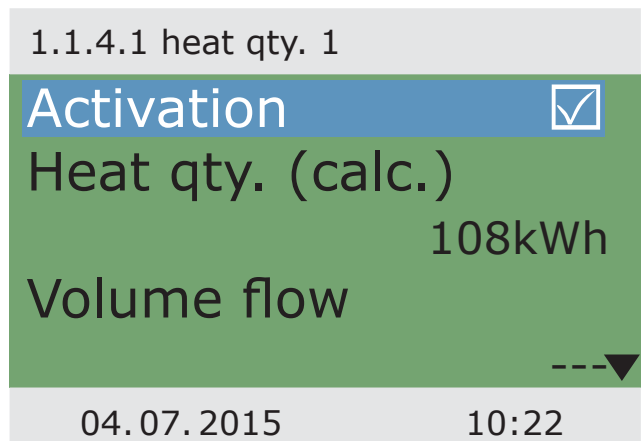

1.1.4.1 heat qty. 1

Return line sensor ---▲
 Supply line sensor ---
 Glycol type

Water

Eff. tank-charge ▼

04.07.2015

10:22

Return and feed sensors are assigned.

The filling can be defined as water, Tyfocor, propylene glycol or ethylene glycol.

>Efficient tank-charge< defines whether this heat quantity is used for efficient buffer charge.

1.1.4.1 heat qty. 1

Supply line sensor ---▲
 Glycol type

Water

Eff. tank-charge

Add to overall HQ

04.07.2015

10:22

>Add to overall HQ< adds each heat quantity to the overall counter.

Continue with >Error list<.

1.1.5 Message list

M33: 4:31 03.07

M32: 6:44 03.07

04.07.2015

10:22

>1.1.5 Error list< appears.

Here, a table of the last errors occurred appears for information.

By selecting a fault ...

... the error message appears in plain text.
 If necessary, take the appropriate measures.
 Return to >1 Main menu<.
 Continue with >Settings<.

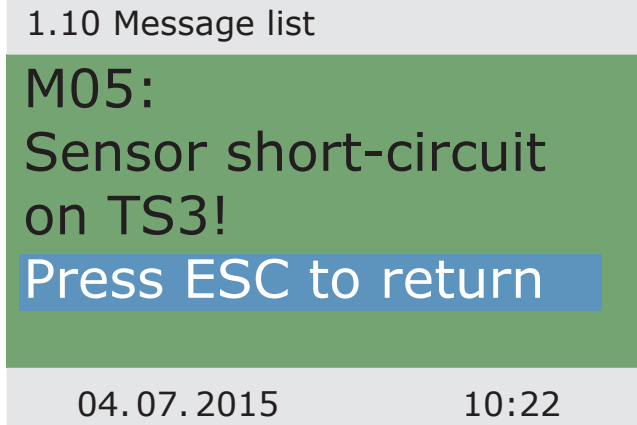

>1.2 Settings< appears.
 Another selection level appears.
 Once the first subitem
 >Date/Time< is selected, ...

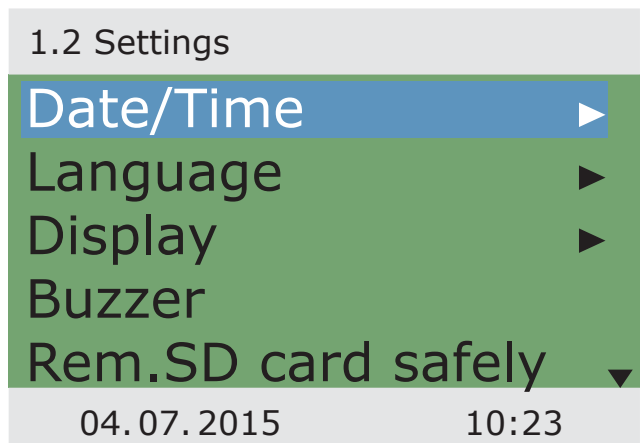

...>1.2.1 Date settings< appears.
 Here, date and time can be set in case of deviation or an extended period of deenergizing.
 If the differential temperature controller is installed at a location where daylight-saving time exists, the time shift can be activated here.

Select the subitem
 >Date< or >Time< by pressing >OK<.

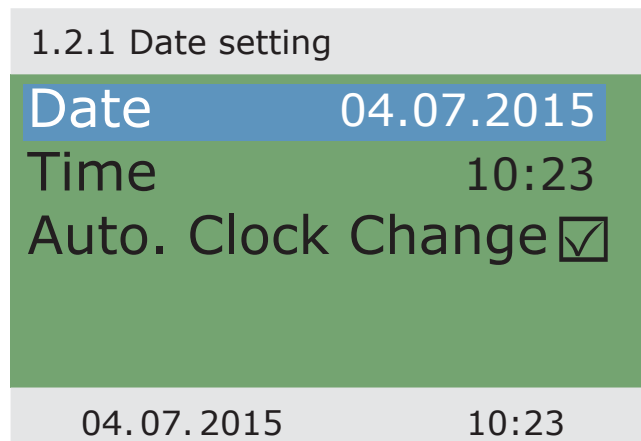

1.2.1 Date setting

Date 04.07.2015
 Time 10:23
 Auto. Clock Change

04.07.2015

10:23

One group of figures each is activated and can be varied via the rotary encoder; whenever >OK< is pressed, the activation jumps to the next group.

Return to >1.2 Settings<.

Continue with >Language<.

1.2.2 Language

Deutsch
 English
 Français
 Italiano
 Svenska

04.07.2015

10:23

>1.2.2 Language< appears.

Here, the user can change over to another available language.

Continue with >Display<.

1.2.7 Display

Brightness 100%
 Blanking time 180s

04.07.2015

10:23

>1.2.7 Display< appears.

>Brightness< serves to adjust the backlighting of the display in steps of 10% from 5% to 100%.

>Blanking time< is used to determine the time after which, in case of inactivity, backlighting is reduced from the set value to 10%. Adjustable in the range from 30 to 255 seconds.

Return to >1.2 Settings<.

If „Buzzer“ is activated, the controller also issues acoustic malfunctions and messages.

Before the SD card can be removed, >Remove SD card safely< must have been selected.

With the „Save parameter“ function, the current configuration is saved on the micro SD card.

The last menu item is >Factory settings<.

By selecting and pressing the button >OK<, followed by >esc<, the preset values are deleted and replaced by the factory settings.

Return to >1 Main menu<.

Continue with >Basic functions<.

>1.3 Basic functions< appears.

Another selection level appears.

Once the first subitem

>Thermostat< is selected, ...

...>1.3.1 Thermostat< appears.

The controller's free outputs can be used as thermostats for various applications.

In professional mode, presettings must be made to this effect - your fitter will explain the appropriate function to you, if necessary.

By selecting a subitem ...

1.2 Settings

Buzzer
 Rem.SD card safely
 Save parameter
 Successfully saved
Factory settings

04.07.2015

10:24

1.3 Basic functions

Thermostat
 Tube collector
 Holiday function
 Delta T control
 Increase return T

04.07.2015

10:25

1.3.1 Thermostat

Thermostat RO2
 Thermostat REL

04.07.2015

10:25

1.3.1 Thermostat R...

Activation

...the appropriate activation screen is displayed.

Return to >1.3 Basic functions<.

Continue with >Tube collector<.

04.07.2015

10:25

1.3.2 Tube collector

Activation

>1.3.2 Tube collectors< appears.

This option is to be activated in case vacuum tube collectors are used.

Return to >1.3 Basic functions<.

Continue with >Holiday function<.

04.07.2015

10:25

1.3.3 Holiday funct...

Start 19.07.2015

End 02.08.2015

>1.3.3 Holiday funct...< appears.

Here, you enter the time of your next holiday. "Holiday" means that the heating/warm water plant is not used in summer.

In this case, the controller will adapt control for the specified period so that overheating of the plant is prevented.

First select the subitem >Start<, then >End< by pressing >OK<.

04.07.2015

10:26

>Edit< appears.

Here, the dates of your absence are entered. Return to >1.3 Basic functions<.

Continue with >Delta T control<.

Edit

Start

19.07.2015

Restore last value
Factory settings

04.07.2015 10:26

>1.3.5 dT control< appears.

Here, parameters of the controller can be changed.

The factory settings of the **smart Sol** can be used for almost all plants.

Ask a fitter before making changes at this point.

Return to >1.3 Basic functions<.

Continue with >Fixed T control<.

1.3.5 dT control

dT ON 1	8.0k
dT OFF 1	4.0k
dT ON 2	8.0k
dT OFF 2	4.0k

04.07.2015 10:27

>1.3.6 Fixed temp.c...< appears.

Here, the temperature values for the collector panels are entered which are to be achieved via control of the pump delivery rate in question.

The factory settings of the **smart Sol** can be used for almost all plants.

Return to >1.3 Basic functions<.

Continue with >Increase return T<.

1.3.6 Fest-Temp-R...

T-fest 1	70.0°C
T-fest 2	70.0°C

04.07.2012 10:27

1.3.8 Increase retu...

Activation	<input checked="" type="checkbox"/>
T ON	8.0K
T OFF	4.0K
T min	15.0°C

04.07.2015

10:27

>1.3.8 Increase retu...< appears.

Parameters for return flow temperature increase can be defined here.

Ask a fitter before making changes at this point.

Return to >1.3 Basic functions<.

Continue with >Post Heating Request<.

1.3.10 Post Heatin...

Hysteresis	10.0K
Time block 1	▶
Time block 2	▶
Time block 3	▶
Time block 4	▶▼

04.07.2015

10:27

>1.3.10 Post Heatin...< appears.

The reheating control reacts to the values of the top tank sensor. If the temperature falls below >t charge< minus the hysteresis, the control activates the reheating cycle via the heating boiler. When the set value is reached the reheating cycle is stopped.

Return to >1 Main menu<.

Continue with >Efficiency functions<.

1.4 Efficiency funct...

Disable recharge ▶

04.07.2015

10:28

>1.4 Efficiency funct...< appears.

Another selection level appears.

Once the first subitem >disable recharge< is selected, ...

... >1.4.3 disable recha...< appears.

This option must be activated if tank recharge during solar charging is to be switched off depending on time or temperature.

To this effect, the fitter must make the appropriate presettings.

Return to >1 Main menu<.

Continue with >Protective functions<.

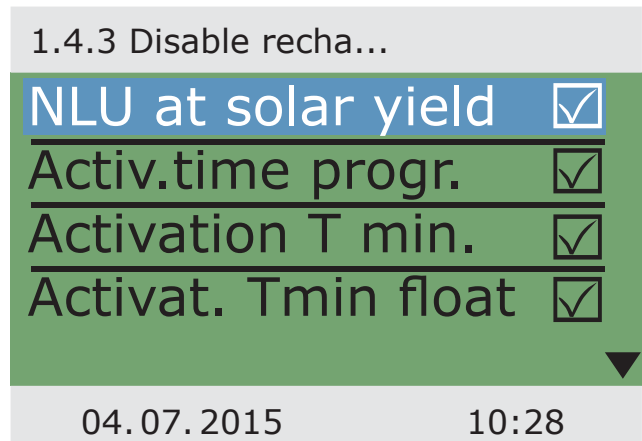

>1.5 Protective funct.< appears.

Another selection level appears.

Continue with >Collector defrost.<.

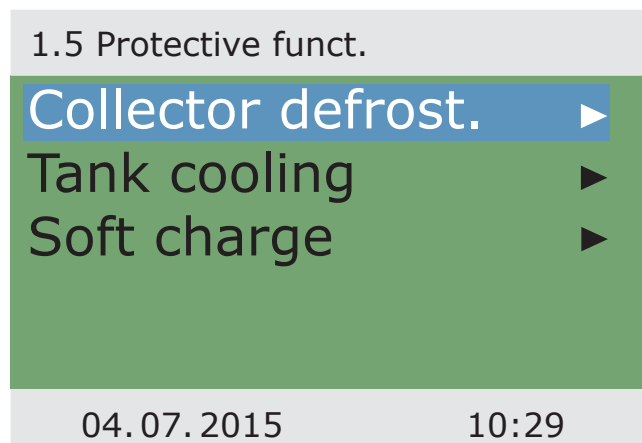

>1.5.2 Defrosting< appears.

>Defrosting< can be used to heat frozen collectors.

At the same time, the tank is cooled!

This is a one-time action which must be repeated as required.

Return to >1.5 Protective functions<.

Continue with >Tank cooling<.

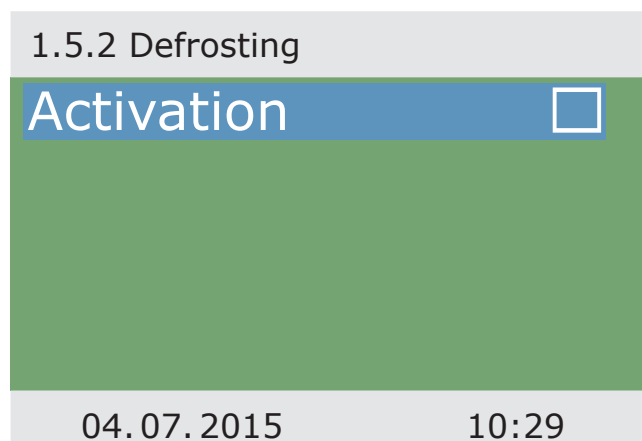

1.5.5 Cooling funct.

Activation

04.07.2015

10:29

>1.5.5 Cooling funct.< appears.

This option must be activated if, during a heat wave, the heat input exceeds the energy withdrawal.

In this case, the controller cools the tank via the collectors, e. g. at night.

Return to >1.5 Protective functions<.

Continue with >Soft charge<.

1.5.6 Soft charge

Activation

04.07.2015

10:29

>1.5.6 Soft charge< appears.

This option should be activated if an extended spell of hot, sunny weather is to be expected. Thus, the heat input in the tank is reduced.

Return to >1 Main menu<.

Continue with >Monitoring<.

1.6 Monitoring

Message list

04.07.2015

10:29

>1.6 Monitoring< appears.

Here, the >message list< can be called up. The required information appears on the display.

Return to >1 Main menu<.

Continue with >Login<.

>1.7 Login< appears.

Here, the fitter can enter his/her access code to perform further settings and changes.

Return to >1 Main menu<.

Continue with >About<.

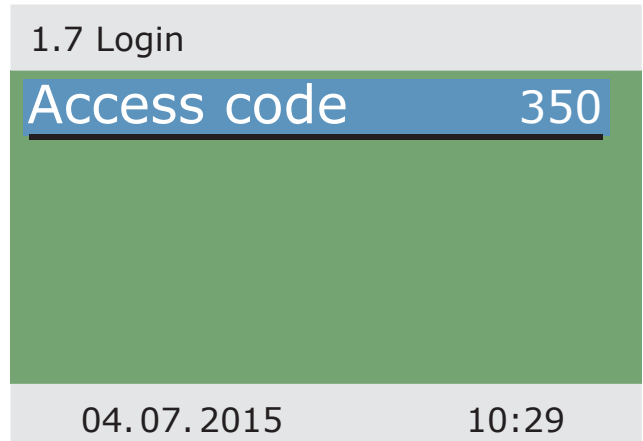

>1.9 About< appears.

Here, the software and hardware version of the controller, the serial number and the date of commissioning appear.

This information is required for repairs and for version management.

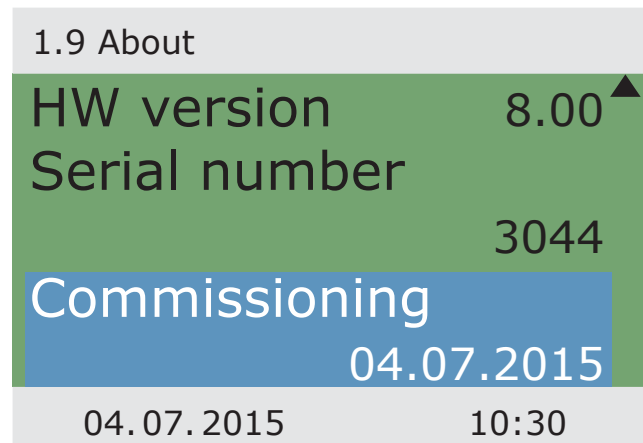

If no entry is made within the preset time (30 - 255 s) on the **smart Sol**, the display returns to >System<.

>esc< is used to return to the home screen from every menu.

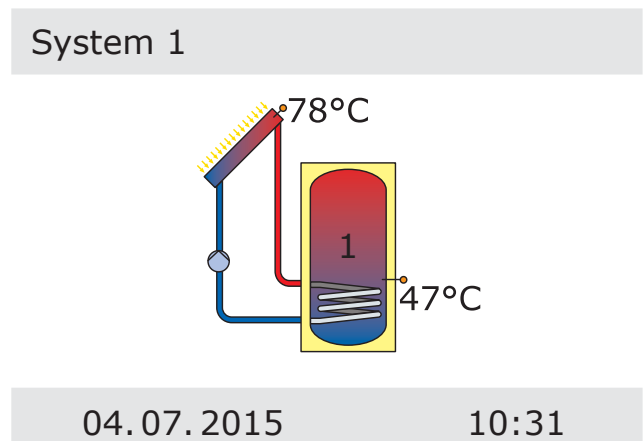



The „Attention“ symbol appears at the top right corner of the display.

A flashing symbol indicates a pending message or an active safety function.

A permanent symbol indicates that there is an active malfunction and the controller is in failure operation.

Select via >OK<.

System 1

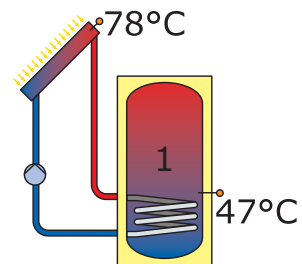

04.07.2015

10:32

If >Safety function< appears in the display, this is a message, no malfunction.

In this case, there is no deficiency, but limits have been exceeded.

The controller indicates that a protective function has been triggered.

The message is only active until normal operation has been restored.

1.10 Service Wizard



Safety function

Solar circuit

emergency cut-off

04.07.2015

10:32



Note!

If a malfunction message appears in the display, the operator can define the possible causes by means of the Service Wizard so that he/she can provide the fitter with precise information.



The differential temperature controller **smart Sol** communicates malfunction processes in plain text. The Service Wizard indicates the possible causes of malfunctions on the basis of the detected symptoms and thus supports immediate and comfortable detection of deficiencies.

There may be various deficiencies in a solar thermal system, which require a wide variety of approaches. The controller communicates every step to the operator or fitter via the screen, so that there is no need to describe all malfunctions in detail in this operating manual.

Here, a malfunction message with troubleshooting process is presented as an example.



Danger!

Mortal danger due to electrocution!
For troubleshooting on the plant, disconnect all poles of the power supply reliably and protect it them against being switched on again!



1.10 Service Wizard



M02:
Breakage of
sensor on TS1!
Menu Next

04.07.2015

10:33

>1.10 Service Wizard< appears.

The malfunction appears in plan text - here:

>M02: Breakage of sensor on TS1!<.

If an analysis/repair is not required at present, press >Menu< to return to the main menu.

1.10 Service Wizard



M02:
Breakage of
sensor on TS1!
Menu Next

04.07.2015

10:33

The Service Wizard helps detect possible causes of malfunctions.

Acknowledge by pressing >Next<.

1.10 Service Wizard



Possible reasons:
Cable/connection
Sensor
Exit

04.07.2015

10:33

For this malfunction, the following causes are assumed:
>Cable/connection< or >Sensor< - select the first menu item and confirm by pressing >OK<.

The controller here provides the troubleshooting instruction to check the connection cable.

Perform the measure in accordance with the recommendation.

Acknowledge by pressing >Next<.

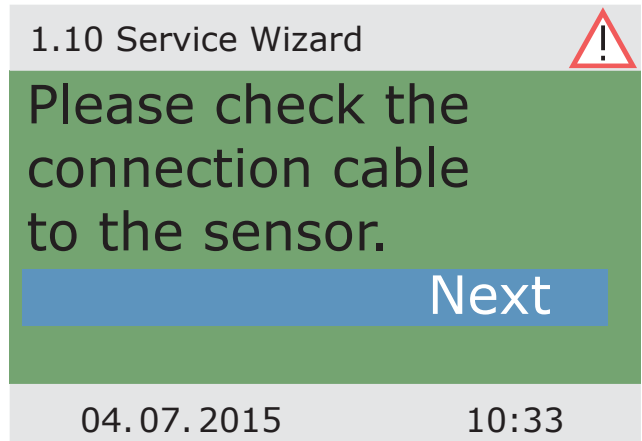

More detailed instructions are available if required.

Acknowledge by pressing >Next<.

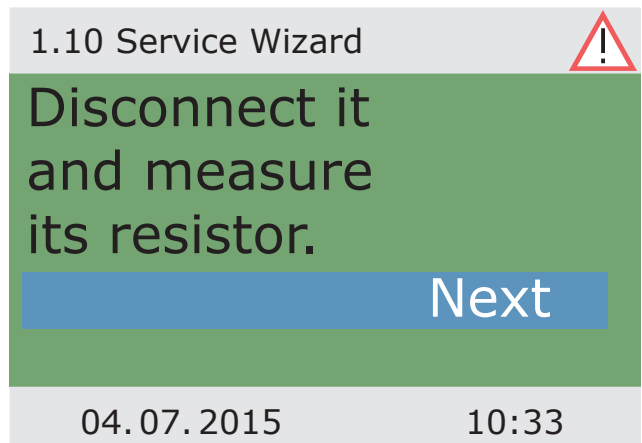

The troubleshooting result is interrogated.

Continue via >Yes< for the case that the malfunction has been determined.

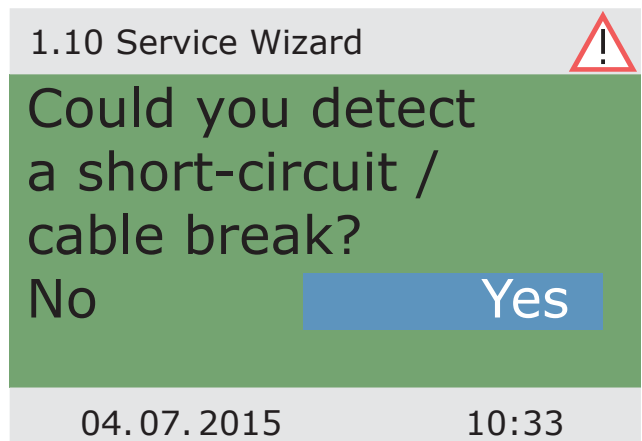

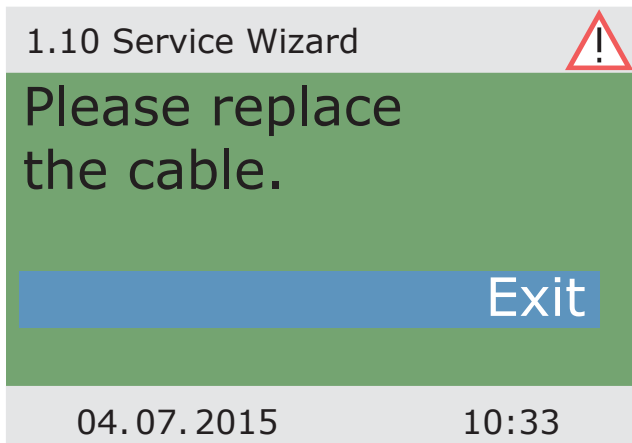

Repair information appears.

Perform the appropriate repair work.

Exit the >Service Wizard< by pressing >Exit<.

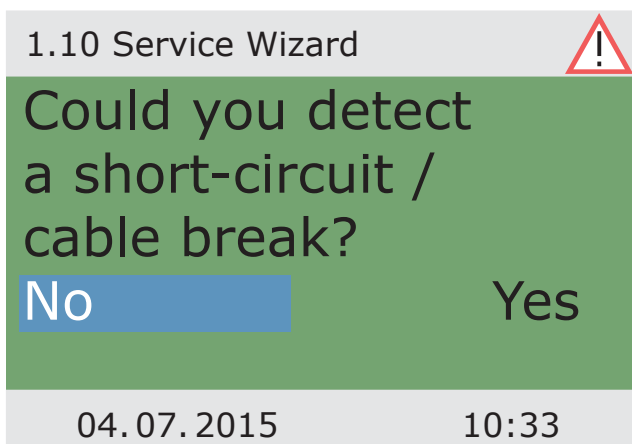

If the cause of the malfunction has not yet been determined, troubleshooting can be continued.

Continue with >No<.

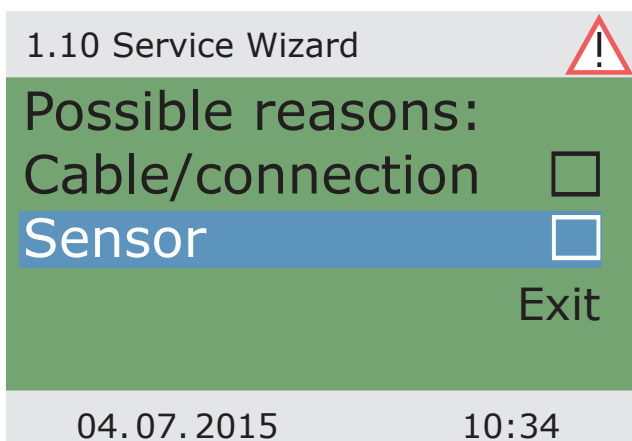

Select all the sources of malfunctions listed, and confirm via >OK<.

Appropriate instructions appear for each source of faults.

Perform the measure in accordance with the recommendation.

Continue with >Explanation<.

1.10 Service Wizard



Please check the sensor for plausible values.

Explanation

04.07.2015

10:34

A part of the information and instructions may be provided in close detail, so that ...

1.10 Service Wizard



Disconnect it and measure its resistor.

Next

04.07.2015

10:34

...the texts may well take several screens.

1.10 Service Wizard



With PT 1000 sensors 0°C to 100°C correspond to a resistor of 1000 to 1385 Ohm. ▼

04.07.2015

10:34

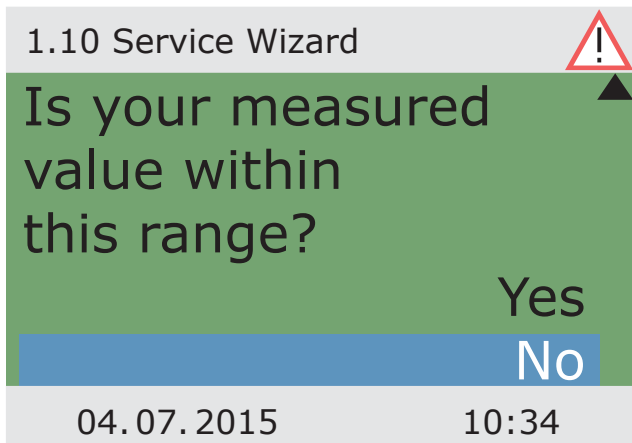

After description of the troubleshooting measure, the result determined by you is interrogated...

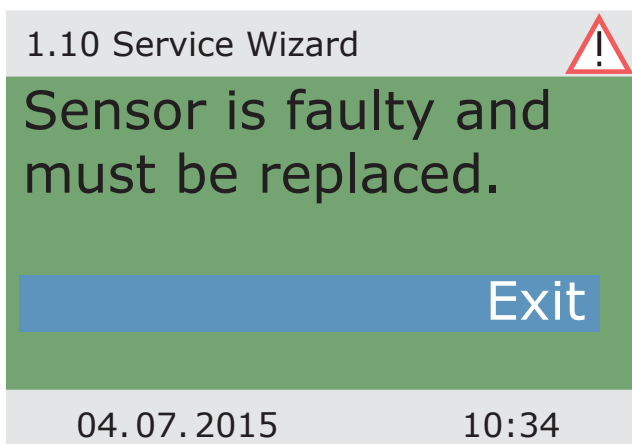

... and the appropriate logical conclusion is made, the repair work displayed.

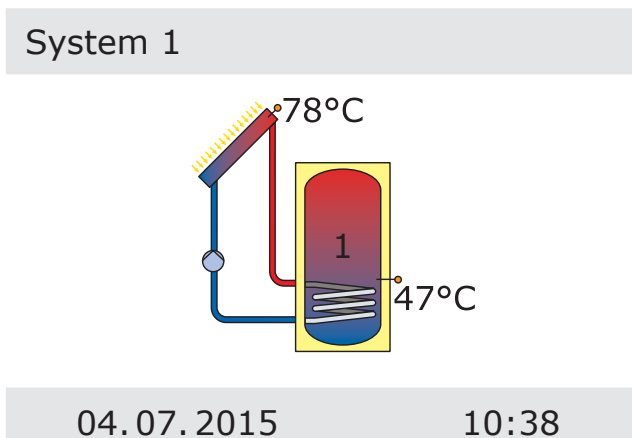

After elimination of the malfunction, the plant screen without the >Attention< symbol appears again on the display, automatic mode is continued.



Danger!

Mortal danger due to electrocution! Before opening the terminal cover, disconnect the power supply reliably!

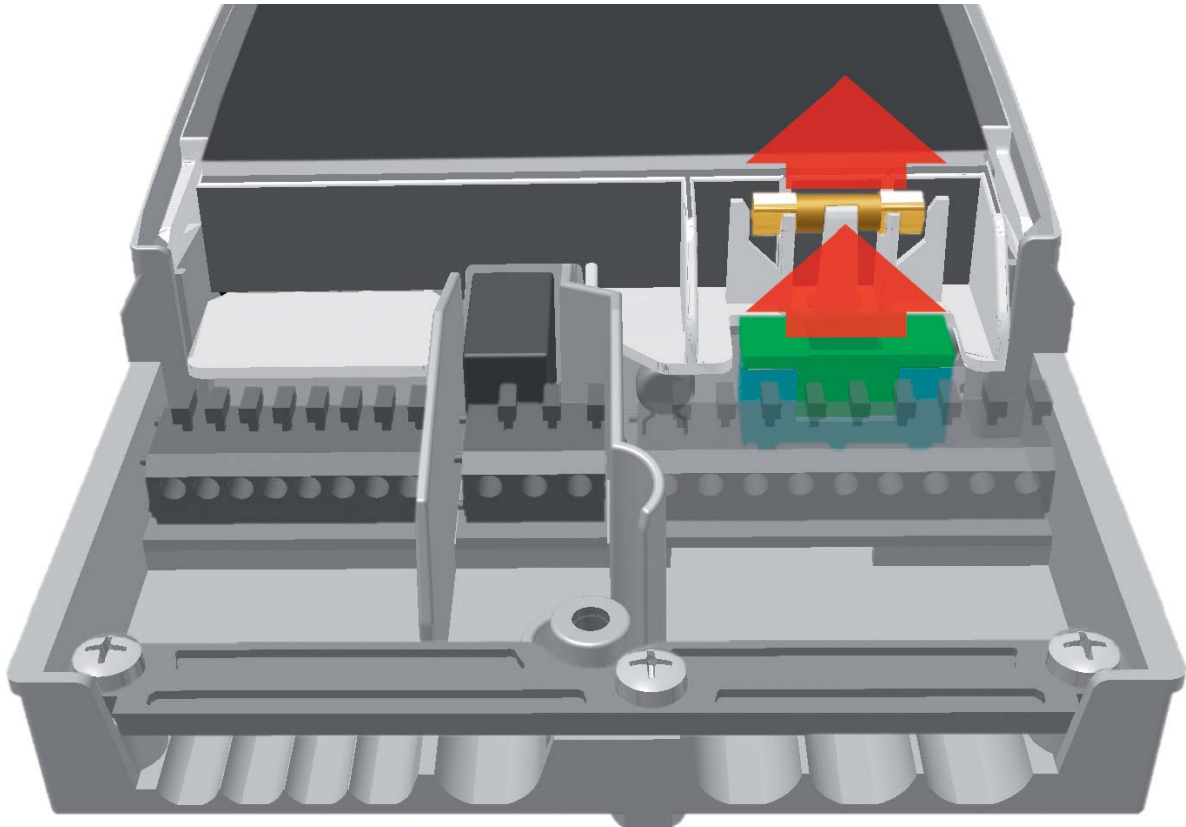

To remove the device fuse, open the terminal cover. Above the right-hand group of terminals, the fuse base and a spare fuse are located. Pull the upper part of the support and the spare part out. The fuse link is clamped in the formed piece and is removed together with the plastic holder.

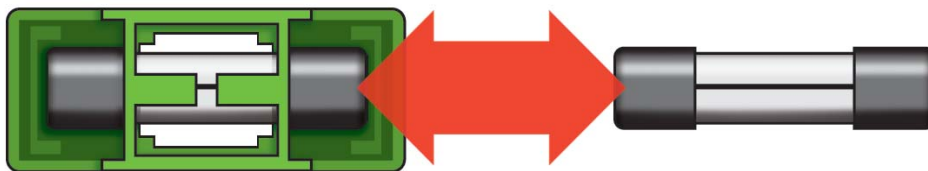

Now, push the micro-fuse laterally out of its holder. The fuse link is installed by reversing the above order. Make sure to procure yourself immediately a new spare fuse!



Danger!

Risk of fire due to overload or short-circuit! Only use fuse links type 5 x 20 mm, T2A!



Important!

In professional mode, settings are made which require detailed knowledge of the heating and solar plant. Moreover, solid specialist knowledge regarding control engineering, hydraulics and solar thermal water heating is required!

If a single parameter is changed, this may affect the safety, function and efficiency of the entire plant!

Leave the settings in professional mode to a specialist workshop, the fitter or heating installer!

Modifications by non-experts tend to result in damage to the plant, rather than to an improvement of its efficiency!



1.7 Login

Access code 350

04.07.2015

10:29

To enter the professional mode, select >1.7 Login< from the main menu, activate and ...

Edit

Access code

365

Restore last value
Factory settings

04.07.2015

10:31

... enter the access code.

The access code to professional mode is >365<.

The fact that the fitter must be available for his/her customers on 365 days per year may serve as a mnemonic trick.

If the professional mode is not exited actively, the controller automatically displays the plant layout after the preset display shut-off time and the value of the access code is reset to 350.

After having returned to >1 Main menu<, the screen shows a list of subitems as in operation mode.

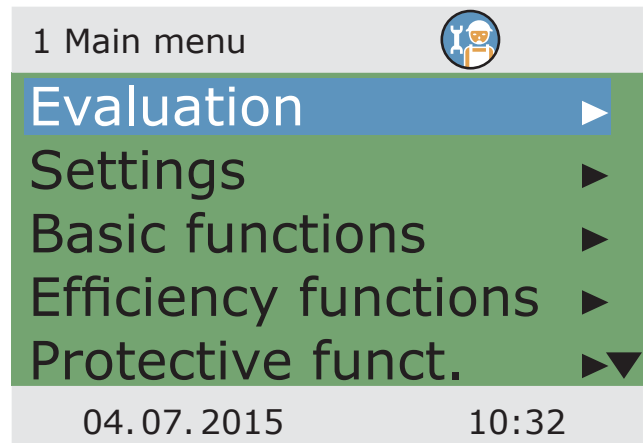

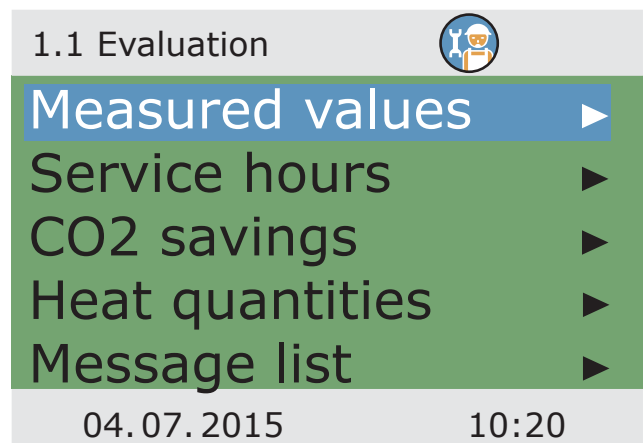

The menu >1.1 Evaluation< is identical to the operating mode.

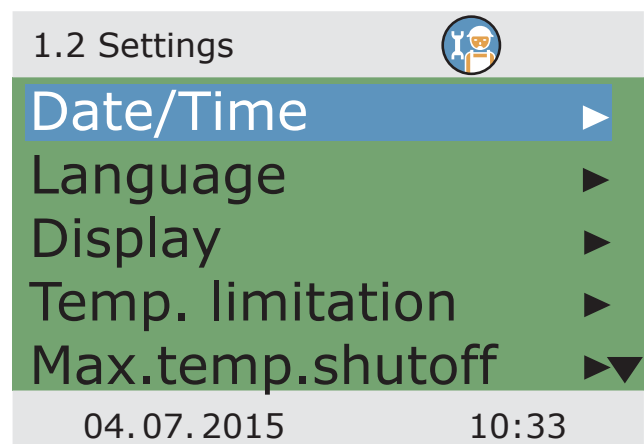

The following items appear under >1.2. Settings< next to the operation mode menus:

- >Temp. limitation<
- >Max.temp.shutoff<



1.2 Settings 

- Max.temp.shutoff ▶▲
- Min. temperature ▶
- Priority charging ▶
- Buzzer
- Rem.SD card safely ▼

04.07.2015 10:33

After scrolling:

- >Min. temperature<

- >Priority charging<

Call up menu item >Temp. limitation<.

1.2.3 Temp.limitation 

- Hyst 5.0K
- T limit 1 60.0°C
- T limit 2 60.0°C

If T-limit>60°, anti-scalding protection must be installed.

04.07.2015 10:34

If the temperature in tank 1 exceeds the value T limit 1, or if the temperature in tank 2 exceeds the value T limit 2, the solar circuit pump is switched off unconditionally.

The pump is not switched on again until the actual temperature falls below the value T limit by the hysteresis >Hyst<.

Example: T limit =60°C minus Hyst=5K => Reclosing temperature 55°C.

Continue via the menu item >Max.temp.shutoff<.

1.2.5 Max.temp.sh... 

- T max.tank 1 59.0°C
- T max.tank 2 59.0°C

04.07.2015 10:34

Maximum temperature of the tanks 1 and 2, to avoid excessively hot water in the tank; the tank in question is only charged to its >T max<.

In case of collector overheating, the tank can be charged up to >T-limit<.

Continue via the menu item >Min. temperature<.

To increase efficiency on charging the tanks, the minimum temperature to be present at the collector in question is entered via >T min. Coll<.

The relevant hysteresis value represents the difference between the switch-ON and switch-OFF temperature.

Continue via the menu item >Priority charge<.

1.2.6 Min.temperat... 

Activation

T min.Coll 1 20.0°C

Hyst.Coll. 1 2.0K

04.07.2015 10:34

In case of dual-tank systems, the tank to be charged first is defined: tank 1, tank 2 or parallel charging.

In case of multi-zone tanks, the charging zone which is charged first is specified: Top tank / bottom tank / without break

>t pause< is used to set the pause time between twot switch-ON tests.

>t charge< serves to define the charging time for the secondary tank.

Once >dT Coll< is reached, the pause time is restarted.

Continue with >Basic functions<.

1.2.8 Priority charg... 

Priority Tank 1

t pause 2min

t charge 20min

dT Coll. 2.0K

04.07.2015 10:34

The following items appear under >1.3. Basic functions< next to the operation mode menus:

- >Thermostat<
- >Output parameter<
- >Collector cooling<
- >Post Heating Requ. ...

1.3 Basic functions 

Thermostat ▶

Output parameter ▶

Tube collector ▶

Holiday function ▶

Collector cooling ▶▼

04.07.2015 10:35

1.3 Basic functions 

- Commissioning ▶
- Delta T control ▶
- Fixed T control ▶
- Increase return T ▶
- Post Heating Requ. ▶

04.07.2015 10:35

... and enhanced menus regarding the

- >Holiday function<
- >Delta T control<
- >Fixed T control<
- >Increase return T<

Call up the menu item >Thermostat<.

1.3.1 Thermostat 

Thermostat RO2 ▶

04.07.2015 10:35

Any controller outputs which are not assigned can be configured as a thermostat.

Select the appropriate thermostat.

1.3.1 Thermostat R... 

Activation

Start

Timer,thermostat

Sensor TS3

Output RO2 ▼

04.07.2015 10:35

Perform activation.

Define the start signal.

Depending on the selection of >Start<, the following parameters are shown.

The output has already been defined by the selection - the related sensor remains to be defined.

Continue to scroll.

Define switch-ON/OFF temperature.

For the heating function,

T ON must be < T OFF.

For the cooling function,

T ON must be > T OFF.

Up to four time slots can be assigned to each thermostat function.

First of all, define the switch-ON times.

Continue to scroll.

1.3.1 Thermostat R... 	
T ON	40.0°C ▲
T OFF	55.0°C
t ON 1	00:00
t OFF 1	00:00
t ON 2	00:00 ▼
04.07.2015	10:35

Define times for activation and deactivation.

Continue via the menu item

>Output parameter<.

1.3.1 Thermostat R... 	
t OFF 2	00:00 ▲
t ON 3	00:00
t OFF 3	00:00
t ON 4	00:00
t OFF 4	00:00
04.07.2015	10:35

Here, the general settings for the assigned outputs are defined.

Continue to scroll.

1.3.7 Output para... 	
Tank ch.-over v 1	▶
Solar pump 2	▶
Boiler	▶
t tear-off	10s
n tear-off	100% ▼
04.07.2015	10:35

1.3.7 Output para... 	
Tank ch.-over v 1	▶▶
Boiler	▶
t tear-off	10s
n tear-off	100%
Speed delta	10%
04.07.2015	10:35

>t tear-off< and >n tear-off< define how long and at which speed the pumps are to run on starting.

Select an output...

Note!

The >Speed delta< parameter defines the speed change for step control. Speed is adjusted by each set value by changing the temperature.

Step control is either selected in the >1.3.5 dT control< menu or in the >1.3.6 Fixed T control< menu.

The „dT target“ parameter specifies the set point of the differential temperature, i.e. the temperature difference aimed at and ideally reached by the controller.

Parameters for the following sample diagram:

- n-min = 30%
- n-max = 100%
- algorithm = dT
(menu 1.3.7)
- dT 1 = 2.0K
- dT-on 1 = 5.0K
- dT-target 1 = 10.0K
- control 1 = stepped
(menu 1.3.5)
- speed delta = 10%
(menu 1.3.7)

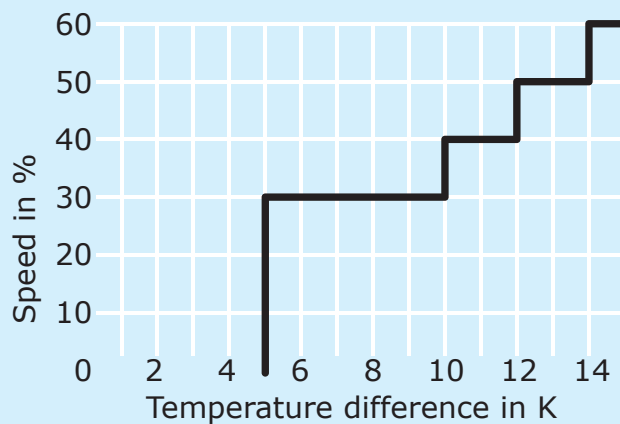

...to define the required control algorithm as >dT< or >Fixed T<.

In case of plants with long piping or slow response, overtravel times for the solar circuit, pump and valve can be determined.

Specify minimum and maximum output n-min / n-max of the pump.

1.3.7 Solar pump 1 

Algorithm dT

Overtravel time 0s

n min. 50%

n max. 100%

04.07.2015 10:35

Similarly, the sub menu for valve control.

The „Inverted“ function inverts the switching function of valves, e.g. if valve installation does not comply with the standard. The controller will then exchange energized and de-energized conditions.

Continue to menu item >Tube collector<.

1.3.7 Tank ch.-ove... 

Algorithm dT

Overtravel time 0s

Inverted

04.07.2015 10:35

To receive correct measured values from the tube collector system, the pump must be switched ON briefly.

By activation of the function, the solar circuit pump can be started time- and/or temperature-controlled.

The time sequence, the pump ON time and ...

1.3.2 Tube collector 

Activation

Start time-dependent

t-ON 10min

T ON 20.0°C

t solar 1 20s▼

04.07.2015 10:35

1.3.2 Tube collector 	
n solar 1	100%
t solar 2	0s
n solar 2	30%
t start	06:00
t end	20:00
04.07.2015	10:35

... the pump delivery rate as a percentage value can be entered.

The two time programs are performed one after the other.

Continue via the menu item >Holiday function<.

1.3.3 Holiday function 	
Start	19.07.2015
End	02.08.2015
04.07.2015	10:35

To avoid overheating of the plant, the controller will suppress yield optimization while the holiday function is activated.

The time frame of the holiday function is mostly defined in operation mode.

Continue to scroll.

1.3.3 Holiday function 	
Tank cooling	<input type="checkbox"/>
Start	00:00
End	07:00
Re-cooling	T min. tank
04.07.2015	10:35

If tank cooling is activated, an appropriate time frame must be defined - this makes sense during the cooler hours of the night - by allowing the controller to dissipate as much energy as possible via the collectors.

Under >Recooling<, determine whether cooling is to be effected down to >T min tank< or >T max tank<.

Continue to scroll.

Under >n pump< set the pump speed in percent.

Enter the hysteresis value by >Hyst<.

If necessary, activate >Soft charging<

>dT< is used to define the switch-ON temperature for the holiday function as a difference from the preset maximum temperature of the tank.

Via >T-min tank 1< and ...

Continue to scroll.

1.3.3 Holiday function 

n pump	100%
Hyst.	5.0K
Soft charge	<input type="checkbox"/>
dT	5.0K
T min tank 1	45.0°C

04.07.2015 10:35

...>T-min tank 2<, specify the minimum temperature required for the tank in question.

Select whether the >Priority tank< or the >Secondary tank< are to be cooled.

Continue via the menu item >Collector cooling<.

1.3.3 Holiday function 

dT	5.0K
T min.tank1	45.0°C
T min.tank2	45.0°C
Tank	Priority tank

04.07.2015 10:35

Here, collector cooling is activated: once the collector temperature >T max. Coll. 1<, or >T max. Coll. 2< is reached, the appropriate solar circuit pump continues to operate until the tank limit temperature is reached.

To protect the pump, the collector emergency switch-off in solar circuits with high-efficiency pumps is reduced to 100°C. Collector cooling is not possible at higher temperatures!

Return to >1.3. Basic functions<.

Continue with >Commissioning<.

1.3.4 Cooling funct. 

Activation	<input type="checkbox"/>
T max.Coll.1	114.0°C

04.07.2015 10:36

0 Welcome 

You really want to start commissioning.?

No Yes

04.07.2015 10:36

Here, new commissioning can be started - e. g. if a new hydraulic system is to be selected.

=> >Commissioning mode< as of page 49.

Continue with >Delta T control<.

1.3.5 dT control 

Activation dT 1	<input type="checkbox"/>
Activation dT 2	<input type="checkbox"/>
dT 1	2.0k
dT ON 1	8.0K
dT OFF 1	4.0K▼

04.07.2015 10:37

If control algorithms have been defined as >dT< under >1.3.7 Output parameter<, the appropriate outputs can be configured here.

Via >dT ON<, the switch-ON temperature, via >dT OFF<, the switch-OFF temperature and via >dT targ.<, the target differential temperature are set. (Differential temperature between collector and tank, bottom).

Continue with >Fixed T control<.

Note!

The >dT targ.1< parameter is displayed in the >1.3.5 dT control< menu for systems with 2 collector fields.

With >dT targ.1< the maximum temperature difference between both collector sensors is specified.

Once this value is exceeded, the pump of the „colder“ collector field is deactivated in order to increase efficiency.

If control algorithms have been defined as >Fixed T< under >1.3.7 Output parameter<, the appropriate outputs can be configured here.

In case of the fixed temperature control, the collector is controlled to the preset temperature via a variable pump delivery rate.

Continue with >Post Heating Requ.<.

1.3.6 Fixed temp.c... 

Control 1

Variant 1

T fixed 1 step-wise 70.0°C

04.07.2015 10:37

Here, reheating can be activated.

The boiler is defined as >Solid-fuel boiler< or >Gas/oil<.

In case of solid-fuel boilers reheating is made via the charge pump of the drinking water tank and is only activated if the temperature of the tank is within the values >Min. temp.< and >Max. temp.<.

1.3.10 Post Heatin... 

Activation

Boiler type Solid fuel boiler

Hysteresis 10.0K

Min. temp. 40.0°C ▼

04.07.2015 10:37

Use >Boiler sensor< to assign the temperature sensor which supplies the temperature value of the boiler.

Up to six time blocks can be activated for reheating.

1.3.10 Post Heatin... 

Max. temp. 55.0°C ▲

Sensor boiler TS4

Time block 1 ▶

Time block 2 ▶

Time block 3 ▶ ▼

04.07.2015 10:37

1.3.10 Post Heatin... 

Activation

Ref. temp. 45.0°C

Starting time 00:00

End time 23:59

04.07.2015 10:37

>Ref. temp.< is used to define the set temperature at the top tank sensor.

If the temperature falls below >Ref. temp.< by >Hysteresis<, the control activates the reheating cycle via the heating boiler until >Ref. temp.< is reached.

1.3.10 Post Heatin... 

Ref. temp. 45.0°C

Starting time 00:00

End time 23:59

Time period
Weekends

04.07.2015 10:37

Each period can be defined with >Saturday<, >Sunday<,>Weekends<, Monday - Sunday< or >Monday - Friday<.

Continue with >Efficiency functions<.

1.4 Efficiency funct... 

Low-Flow ▶

Quick-charging ▶

Disable recharge ▶

Efficient tank-charge▶

04.07.2015 10:38

The following items appear under >1.4. Efficiency funct.< next to the operation mode menus:

- >Low-Flow<
- >Quick-charging<
- >Efficient tank-charge<

Call up menu item >Low-Flow<.

Here, the switch-ON temperature can be defined for low-flow plants.

Continue with >Quick-charging<.

1.4.1 Low-Flow 

Activation

T ON 60.0°C

04.07.2015 10:38

Tank quick charging changes over from dT control to fixed temperature control.

>T ON< and >T OFF< define the change-over range and >T targ. Coll.< the fixed temperature on the collector.

An upper tank sensor is required for quick-charging.

Continue with >Disable recharge<.

1.4.2 Quick-charging 

Activation

Sensors TS3

T ON 48.0°C

T OFF 52.0°C

T targ.Coll. 70.0°C

04.07.2015 10:38

If the plant has been designed accordingly and a system involving disable recharge selected, the appropriate parameters are set here.

The recharge suppression during solar charging can be activated here.

Here, the time control and/or the temperature control are activated - possible for all systems with heating boiler control.

Time and temperature control can be used in combination.

Select the time slot via >Start< and >End<.

Continue to scroll.

1.4.3 disable recha... 

NLU at solar yield

Activ.time progr.

Start 08:00

End 22:00

04.07.2015 10:39

1.4.3 disable rech... 

Activation T min.

T min.tank 45.0°C

Activat.Tmin Float

04.07.2015 10:39

Select the minimum temperature via >T min.tank<.

Here, the efficiency-optimized disable recharge is enabled and activated - possible for all systems with heating boiler control.

Continue to scroll.

1.4.3 disable recha... 

Emphasis

Balanced

T targ. 45.0°C

T floating

upper tank sensor

04.07.2015 10:39

„Emphasis“ can be set as „High comfort“, „Low comfort“, „Balanced“, „Low solar share“ or „High solar share“; it specifies the ratio of recharge and solar yield.

Determine under >T floating< whether the temperature is to be measured on the upper or lower tank sensor.

Continue to scroll.

1.4.3 disable recha... 

T targ. 45.0°C

T floating

upper tank sensor

T min.tank 45.0°C

04.07.2015 10:39

Enter the minimum tank temperature via >T min tank<.

Continue with >Efficient tank-charge<.

>Efficient tank charge< is activated and configured here. The solar circuit pump is controlled according to the entered heat quantity. In order to use this functionality, a heat quantity counter must be configured in the solar circuit (=> >1.1.4 Heat quantities< menu).

The >t delay after t. change< parameter defines the time between two speed changes. Once the waiting time has expired, the speed of the solar pump is increased or decreased by 10%.

With the >Performance delta< parameter, the additional yield which is necessary during the waiting time for the pump speed to change accordingly is set.

Return to >Main menu<.

Continue with >Protective funct.<.

The following items appear under >1.5. Protective funct.< next to the operation mode menus:

- >Anti-Blocking<
- >Antifreeze protection<

Call up menu item >Anti-Blocking<.

The pumps can be moved daily to prevent them from getting blocked.

This function is not activated as long as the pumps are activated in normal operation.

Determine the time of the day and the operating period.

Continue with >Collector defrost.<.

1.4.4 Efficient tank ch... 

Activation

t del.after t ch. 4.5min

Perform. delta 100W

04.07.2015

10:38

1.5 Protective funct. 

Anti-blocking ▶

Collector defrost. ▶

Antifreeze protect. ▶

Anti-legionellae ▶

Tank cooling ▶▼

04.07.2015

10:40

1.5.1 Anti-block pr... 

Start 11:00

Duration 5s

04.07.2015

10:40

1.5.2 Defrosting



Activation
 Defrosting 5min

>Defrosting< can be used to heat frozen collectors.

At the same time, the tank is cooled!

Set the pump runtime.

Continue with >Antifreeze protect.<.

04.07.2015

10:41

Note!

The antifreeze protection function of the controller may prevent the heating system from damage which could be caused by freezing medium. To this end, enter the lowest temperature „T ON“ at which a system filled with pure water without antifreeze could operate without suffering damage.

If antifreeze is used, the controller will calculate the adjusted antifreeze protection temperature from the entered values for type and portion displaying it as „T ref“.

1.5.3 Antifreeze pr...



Activation
 T ref 5.0°C
 T ON 5.0°C
 Glycol type Water▼

Activation and setting of the anti-freeze protective function for the collector.

Via >T ON<, enter the anti-freeze protection temperature for water-filled plants.

When anti-freeze products are used, the type and the proportion can be entered; the anti-freeze protection temperature is calculated automatically.

Continue to scroll.

04.07.2015

10:42

In the case of plants with two tanks, the source of the anti-freeze protection heat must be selected by specifying >Priority tank< or >Secondary tank<.

Continue with >Anti-legionellae<.

1.5.3 Antifreeze pr. 

T ON 5.0°C ▲

Glycol type Water

Tank Priority tank

04.07.2015 10:42

These parameters must be set by the fitter based on the applicable national regulations. >Function< is used to define the period in days (1day - 7days) during which legionella reduction must have occurred at least once.

>t-ON< is used to define the time of a possibly required reheating cycle.

>T legionellae< defines the disinfection temperature. >t monitor<< is used to define the minimum disinfection time.

Continue with >Tank cooling<.

1.5.4 Anti-legionellae 

Repetition 1 day

T legionellae 60.0°C

t-ON 01:00

t-monitor 60min

Activation

04.07.2015 10:43

Here, the parameters for tank cooling are defined.

>t-ON< and >t-OFF< are used to define the appropriate time slot in which the tank is to be cooled via the collector, and >Hyst.tank 1< and >Hyst.tank 2< are used to define the switch-ON hysteresis.

Continue to scroll.

1.5.5 Cooling funct. 

Activation

Hyst.tank 1 2.0K

Hyst.tank 2 2.0K

t-ON 00:00

t OFF 07:00 ▼

04.07.2015 10:43

1.5.5 Cooling funct. 	
Hyst.tank 1	2.0K ▲
Hyst.tank 2	2.0K
t-ON	00:00
t OFF	07:00
Adjusting balance	<input type="checkbox"/>
04.07.2015	10:43

If the adjusting balance is activated, the heat dissipated via the collector is deducted from the energy balance calculation.

Continue with >Soft charge<.



Note!

To protect the pump, the collector emergency switch-off in solar circuits with high-efficiency pumps is reduced to 100°C. Soft charge is not possible at higher temperatures!



1.5.6 Soft charge 	
Activation	<input type="checkbox"/>
T min. tank1	45.0°C
T min. tank2	45.0°C
Start	30.05.
End	31.07.
04.07.2015	10:43

Soft charging sets the plant to protection mode to prevent excessively high tank temperatures.

The start temperatures for two tank circuits and the appropriate calendar period are determined here.

Return to >Main menu<.

Continue with >Monitoring<.

The following items appear under >1.6. Monitoring< next to the operation mode menus:

- >DiffTemp<
- >Volume flow<
- >Coll.Emerg.OFF<
- >Sensor balancing<

Call up the menu item >DiffTemp<.

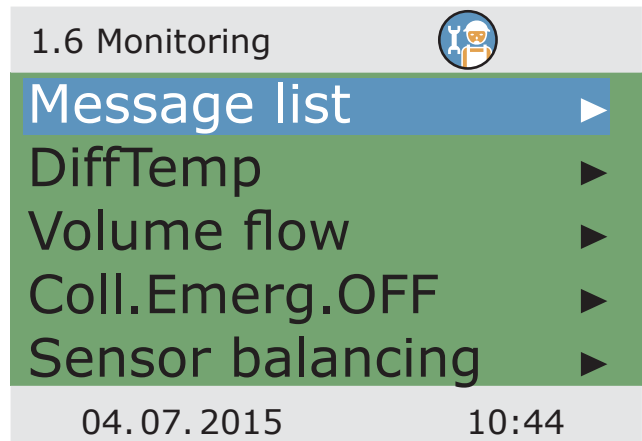

>dT monitoring< is used to define the criteria which lead to fault detection.

>dT coll/stor< is used to define a differential temperature between collector and tank, and >t max.coll/tank< for the relevant period of time.

If >dT coll/stor< is exceeded within >t max.coll/tank<, the controller detects a fault.

With >Monitoring of<, the monitoring of the feed and return temperature of the heat counter can be selected.

Continue with >Volume flow<.

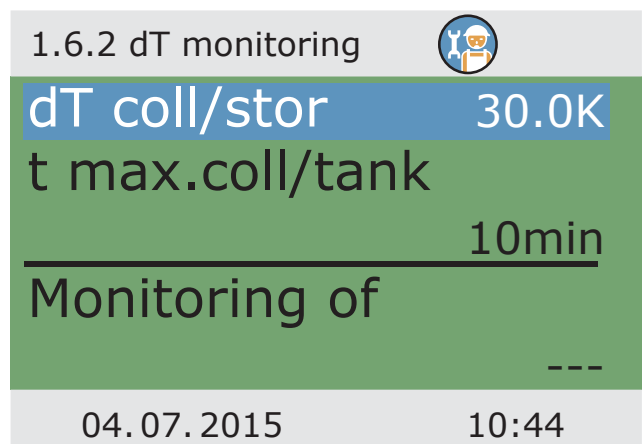

>Phi monitoring< accesses any flow menu for which volume flow sensors have been configured.

Select appropriate submenu.

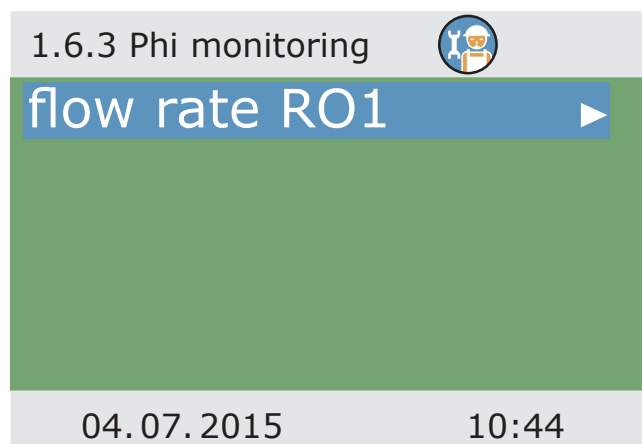

1.6.3 Phi monitoring 

phi min.error	0.10l/min
phi circulation	1.00l/min
t undercut	

04.07.2015 10:44

Here, the parameters for volume flow monitoring are defined.

Continue with >Coll. Emerg.OFF<.

1.6.4 Emerg. OFF 

T limit Coll.1	100.0°C
Hyst.	5.0K

04.07.2015 10:45

>T limit Coll. 1< or >T limit Coll. 2< are used to switch OFF the appropriate solar circuit pumps to prevent destruction.

To protect the pump, the collector emergency switch-off in solar circuits with high-efficiency pumps is reduced to 100°C.

Under >Hyst<, the value is entered by which the limit temperature must be undercut to cancel the forced shut-off.

Continue with >Sensor balancing<.

1.6.5 Sensor balan... 

TS1 Offset	0.0°C
TS2 Offset	0.0°C
TS3 Offset	0.0°C
TS4 Offset	0.0°C

04.07.2015 10:46

Long piping and other factors may distort measured variables.

Here, an offset value can be entered for each sensor.

Return to >Main menu<.

Continue with >Login<.

Continue with >Manual mode<.

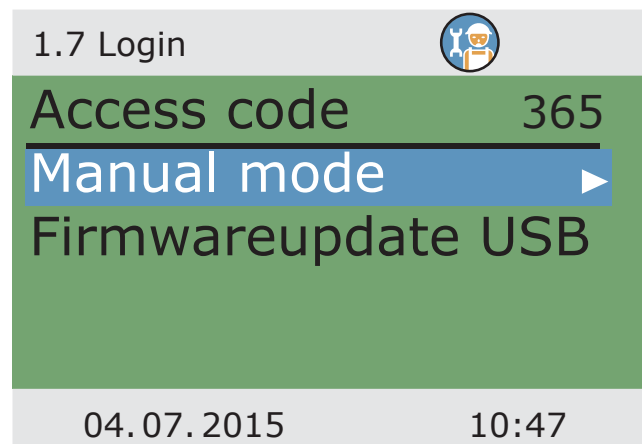

Note!

After the selection of the >USB firmware update<, the display flashes every second.

Use a USB cable to connect to a PC already installed with update software.

If controller and PC have already been connected, they must be briefly disconnected again.

The update software uploads the DFU file. The display continues to flash and the progress is displayed on the PC.

If the update has not begun within one minute after the selection of >USB firmware update<, the controller will restart.

If the update process is aborted, and so the controller is not ready for operation, it must be switched off. (Disconnected from the mains.) When switching it on again, press the „esc“ key until the display flashes. The update process can now be repeated.

In manual mode, the individual outputs can be activated for testing purposes, e. g. to check that a pump is working properly.

Select output, activate with „OK“, select „On“ on the rotary encoder and activate with „OK“. The connected pump and/or the connected valve must now be activated.

Manual mode can only be exited by pressing >esc<.

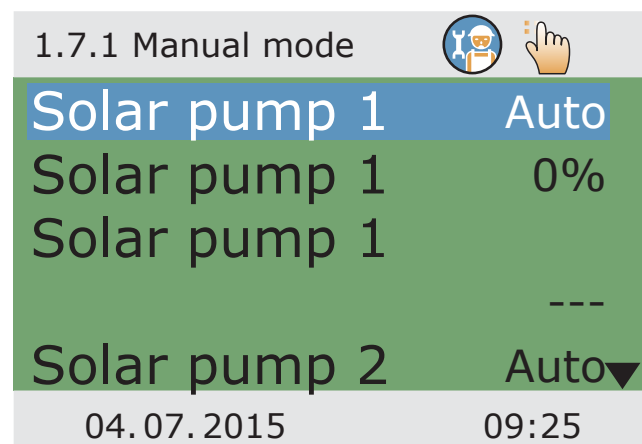



Danger!

Mortal danger due to electrocution!
Before opening the terminal cover,
disconnect all poles of the power supply reliably!



For disassembly of the differential temperature controller **smart Sol**, reverse assembly procedure:

- Disconnect the power supply.
- Open the terminal cover.
- Disconnect all cables.
- Release the wall screw fastening.
- Remove the controller from its mounting location.



Danger!

Mortal danger due to electrocution!
When removing the controller, secure all stripped
cable ends so that they cannot be touched by persons!
Remove cables completely on definite removal.



Important!

The person who or the institute which is responsible for disposal of the device must not discard the controller with the residual waste, but must ensure correct recycling in accordance with the local provisions!

In case of doubt, ask the local disposal company or the authorized dealer from which you have purchased the device.



The differential temperature controller **smart Sol** was developed, manufactured and tested according to stringent quality and safety specifications and corresponds to the state of the art.

The device is subject to the warranty period prescribed by law of 2 years after the date of sale.

The seller shall eliminate all defects in material and workmanship which occur on the product during the warranty period and which impair the product's functionality.

Natural wear and tear does not constitute a defect.

Warranty and liability does not include all damage which is due to one or several of the following reasons:

- Non-compliance with these Assembly and Operating Instructions.
- Inappropriate transport.
- Faulty assembly, commissioning, maintenance or operation.
- Modifications of the structure or tampering with the software of the device.
- Installation of supplementary components which are not approved by the manufacturer.
- Continued use of the controller despite an obvious defect.
- Use of non-approved spare parts and accessories.
- Applications exceeding the intended scope of utilization.
- Inappropriate utilization of the device / improper handling, e. g. ESD.
- Use of the device outside of the admissible technical boundaries.
- Voltage surges, e. g. due to lightning strokes.
- Force majeure.

Further claims based on this warranty obligation, especially compensation for damage exceeding the asset value of the differential temperature controller, are excluded.

Construction, design and project engineering of heating installations are performed by specialist fitters based on the applicable standards and directives.

The functioning and safety of a plant are the exclusive responsibility of the companies commissioned with planning and execution.

Contents and illustrations of this manual have been elaborated to the best of our knowledge and with utmost diligence - we reserve the right of error and technical modifications.

Liability of the manufacturer for inappropriate, incomplete or incorrect information and all damage resulting therefrom is excluded on principle.

Name of operator and place of installation:

Date of commissioning:

Installed hydraulic system:

Collector surface, in total [m²]:

Tank sizes [l]:

Anti-freeze agent Type/concentration:

Particularities:

The solar thermal plant with the differential temperature controller **smart Sol** has been installed and commissioned in an expert fashion.

The owner / operator of the plant was informed in detail and instructed as regards the design, operation, handling, especially in connection with the differential temperature controller **smart Sol**.

Commissioning by the company (name/address/telephone number):

Name of employee:

Error pattern/error description:

Error message: _____

Software version: _____

Service Wizard executed: Yes No _____

Screens:

TS1: _____

TS2: _____

TS3: _____

TS4: _____

TS5: _____

TS6: _____

TS7: _____

TS8: _____

Wiring:

RO1: Pump HE Valve _____

RO2: Pump HE Valve _____

REL: Yes No _____

Service hours:

RO1: _____

RO2: _____

REL: _____

Equipment/Accessories/Options: _____



Important!

For repair or replacement of the controller, make sure that completed copies of the commissioning report and of the error report are included!



The manufacturer

emz-Hanauer GmbH & Co.KGaA
Siemensstraße 1
D - 92507 Nabburg

declares in its sole responsibility that the following product:

Differential temperature controller **smart Sol**

to which this Declaration refers, complies with the following directives and standards:

Directive 2006/95/EC of the European Parliament and the Council dated 12 December 2006 on the harmonization of the laws of the Member States relating to electrical equipment designed for use within certain voltage limits.

Directive 2004/108/EC of the European Parliament and the Council dated 15 December 2004 on harmonization of the laws of the Member States relating to electro-magnetic compatibility and abolition of the Directive 89/336/EEC.

Directive 2001/95/EC of the European Parliament and of the Council dated 3 December 2001 regarding general product safety.

Technical regulations, Low-Voltage Directive:

EN 60730-1:2000 + AC:2007

Technical regulations, EMC Directive:

EN 60730-1:2000 + A1:2004 + A12:2003 + A13:2004 + A14:2005 (EMC part)

EN 55022:1998 + Corr. 1999 (Class B)

EN 61000-3-2:1995 + corr. July 1997 + A1: 1998 + A2:1998 + A14:2000

EN 61000-3-3:1995 + A1:2001 + A2:2005

D - 92507 Nabburg, 29.04.2013,

Signed by

Thomas Hanauer
Managing Director

pp Josef Irlbacher
Head of the Electronic Development Team

A ccess code	91	M alfunction	84 ff.
Active system	12	Manual mode	112
Antifreeze	107	Maximum temperature	93
Anti-blocking	106	Menu structure	68
Anti-legionella function	45/108	Message list	73
Automatic mode	66	Minimum temperature	94
B reak-out segments	10/15	O peration of the controller	11
Brightness	75	Output parameter	96 f.
C able cross sections	8	P hi monitoring	111
Cable diameter	15	Priority charge	94
Cleaning	6	Professional mode	91 ff.
Collector cooling	100	Protective functions	106
Commissioning mode	49/101	PWM control signal	17
Connection	15 ff.	Q uick-charging	104
Connection diagram, switching valve	16	R eduction of legionella	45/108
D ata interfaces	19	Reheat function	45/79/102 f.
Date/Time	74	Return temperature increase	79
Defrosting	80/107	Rotary encoder	11
Description	6	S afety fuse	90
Differential temperature	17	S cope of Supplies	8
Disable recharge	46/80/104	Sensor balancing	111
Disposal	114	Sensor line	6
E fficient tank charge	106	Service wizard	84 ff.
Emergency OFF	111	Soft charge	81/109
Evaluation	70 ff./92	Software version	82
F unctions for boiler control	45 ff.	Solar yield	17
G uided diagnostic process	84 ff.	Speed delta	97
H igh-efficiency pump	17	Strain relief device	10/15
Holiday function	77/99	Switching valve	16
Hydraulic systems	21 ff.	T ank cooling	81/108
I mpeller	17	Temperature limit	93
Intended Use	8	Temperature sensor	6
L egend to symbols	20	Thermostat functions	48/95
Login	82/91	Tube collector	77/98
Low-Flow plant	104	V olumetric flow sensor	17
		Vortex sensor	17
		W all-mounting	14

Edition BE 01/2015
0132 - 42WMSUGAT2-C



Cerbo

küttesüsteemid • müük • paigaldus • hooldus
tel 442 0222 / 434 1000 • www.cerbo.ee • info@cerbo.ee

LK ARMATUR AB

Garnisonsgatan 49 • SE-254 66 Helsingborg • Sweden

Tel: +46 (0)42-16 92 00 • Fax: +46 (0)42-16 92 20

info@lkarmatur.se • order@lkarmatur.se

www.lkarmatur.se

 [youtube.com/lkarmatur](https://www.youtube.com/lkarmatur)



LK Armatur