

Uponor Smatrix

EN Technical information



Table of contents

| | | | | | |
|-----------|---|-----------|--|--|--|
| 1 | Uponor Smatrix..... | 3 | | | |
| 1.1 | Intelligent controls for heating and cooling..... | 3 | | | |
| 2 | Room control - Functions..... | 5 | | | |
| 2.1 | Basic functions..... | 5 | | | |
| 2.2 | Installation and configuration functions..... | 7 | | | |
| 2.3 | Comfort functions..... | 7 | | | |
| 2.4 | Technical functions..... | 7 | | | |
| 3 | Supply water control - Functions..... | 9 | | | |
| 3.1 | Basic functions..... | 9 | | | |
| 3.2 | Comfort functions..... | 10 | | | |
| 3.3 | Technical functions..... | 10 | | | |
| 4 | Room control - Component description..... | 12 | | | |
| 4.1 | Uponor Smatrix Pulse Communication module..... | 12 | | | |
| 4.2 | Uponor Smatrix Wave Pulse..... | 12 | | | |
| 4.3 | Uponor Smatrix Base Pulse..... | 14 | | | |
| 4.4 | Uponor Smatrix Base PRO..... | 16 | | | |
| 5 | Supply water control - Component description..... | 20 | | | |
| 5.1 | Uponor Smatrix Move..... | 20 | | | |
| 5.2 | Uponor Smatrix Move PRO..... | 21 | | | |
| 6 | Thermostats and sensors - Component description..... | 22 | | | |
| 6.1 | Uponor Smatrix Wave..... | 22 | | | |
| 6.2 | Uponor Smatrix Base..... | 26 | | | |
| 6.3 | Uponor Smatrix Move PRO..... | 29 | | | |
| 7 | Network connectivity..... | 30 | | | |
| 7.1 | Uponor Smatrix Wave Pulse..... | 30 | | | |
| 7.2 | Uponor Smatrix Base Pulse..... | 31 | | | |
| 8 | Application examples – Wave Pulse..... | 32 | | | |
| 8.1 | Underfloor heating or underfloor heating/cooling with multiple sub room controllers..... | 32 | | | |
| 8.2 | Underfloor heating or underfloor heating/cooling with a single room controller..... | 35 | | | |
| 8.3 | Underfloor heating/cooling with two stand alone room controllers..... | 38 | | | |
| 8.4 | Underfloor heating and radiators with multiple sub room controllers..... | 40 | | | |
| 8.5 | Underfloor heating or underfloor heating/cooling, and electrical underfloor heating with a single room controller.... | 42 | | | |
| 8.6 | Underfloor heating or underfloor heating/cooling, and fancoils with a single room controller..... | 45 | | | |
| 8.7 | Underfloor heating with ceiling cooling, 2-pipe, and a single room controller..... | 47 | | | |
| 8.8 | Underfloor heating with ceiling cooling, 4-pipe, and a single room controller..... | 48 | | | |
| 8.9 | Underfloor heating with extra loop in an additional room..... | 49 | | | |
| 8.10 | Ceiling cooling with eg. Tichelmann loops..... | 50 | | | |
| 9 | Application examples – Base Pulse..... | 51 | | | |
| 9.1 | Underfloor heating or underfloor heating/cooling with multiple room controllers..... | 51 | | | |
| 9.2 | Underfloor heating or underfloor heating/cooling with a single room controller..... | 54 | | | |
| 9.3 | Underfloor heating/cooling with two stand alone room controllers..... | 57 | | | |
| 9.4 | Underfloor heating or underfloor heating/cooling, and electrical underfloor heating with a single room controller.... | 59 | | | |
| 9.5 | Underfloor heating with ceiling cooling, 2-pipe..... | 61 | | | |
| 9.6 | Underfloor heating with ceiling cooling, 4-pipe..... | 62 | | | |
| 10 | Application examples – Move..... | 63 | | | |
| 10.1 | Supply water temperature control, heating..... | 63 | | | |
| 10.2 | Supply water temperature control, heating/cooling..... | 63 | | | |
| 11 | Application examples – Move PRO..... | 65 | | | |
| 11.1 | Industrial/Retail with offices and Snow melt - KNX..... | 65 | | | |
| 11.2 | Industrial/Retail and Snow melt - Modbus..... | 66 | | | |
| 11.3 | Industrial/Retail with offices and Snow melt - Heating and Cooling..... | 67 | | | |
| 11.4 | Industrial/Retail with offices and Snow melt..... | 69 | | | |
| 11.5 | Snow melt..... | 70 | | | |

1 Uponor Smatrix

1.1 Intelligent controls for heating and cooling



Smatrix is Uponor's product line of fully integrated control systems for radiant heating and cooling. Developed to fully leverage the advantages of a radiant system, Smatrix increases energy-efficiency while ensuring optimal comfort in every single room. With intelligent room, zone and supply water controls, Smatrix offers modular and expandable systems that are easy to install and meet the requirements of any building project - from new build to renovation. Key features include Uponor's autobalancing technology that can save up to 20 % in energy, a cooling function with high protection to avoid condensation, and in the Smatrix Pulse product lines, the option for remote access via smartphone or tablet.

Autobalancing for more comfort and efficiency

Conventional systems need to be balanced manually in order to ensure that each room receives the required output. If left unbalanced and with a uniform flow rate, some rooms can be overpowered while others are underpowered. A system not balanced correctly thus requires a greater input of energy to heat or cool all rooms adequately.

The autobalancing technology of the Smatrix room controls constantly calculates and adjusts the exact amount of energy needed to ensure optimal comfort in every single room. This saves up to 20 percent in energy compared to unbalanced systems without room by

room control. The technology also eliminates the need to balance the system as part of commissioning.

In renovation projects, the autobalancing function easily adapts to an existing installation. This eliminates the need for a new calculation as basis for manual balancing of the existing system, which in many cases is not even possible because the required information is not available. Even small changes in a building's interior can affect conventional underfloor systems, as the required amount of water at a given supply temperature can change, e.g., with a different floor covering. Here again, autobalancing allows Smatrix to automatically adapt to these changes, ensuring home owners and tenants full flexibility in furnishing their home and maintaining comfort.

Cooling with high protection to avoid condensation

When required, Smatrix can effectively control the cooling process. The system then operates in reverse by opening actuators when the room temperature rises above a certain threshold. As it is the case with heating, the autobalancing function ensures that every room receives exactly the right amount of cooling energy.

In cooled spaces, relative humidity can become a problem. With humidity sensors included in the room thermostats, Smatrix provides

a high protection to avoid condensation. If the humidity in a single room gets too high, the cooling process can be automatically stopped or a notification given. It is even possible to integrate a dehumidifier into the system.

Some cooling installations using multiple emitters, such as floor and fancoils, might require the autobalancing function to be switched off. See the Installation and operation manual for more information.

Smatrix room, zone and supply water controls

The Smatrix Wave and Base product lines (room temperature control), include the autobalancing technology and cooling function. Using predefined temperature settings, they can routinely reduce the room temperature, e. g. at night. The room controls are easy to install with minimal wiring – or even completely wireless: Smatrix Base Pulse offers a wired option. Smatrix Base PRO offers a non residential wired solution that can be combined in a KNX Building Management System. Smatrix Wave Pulse employs a wireless control with additional comfort and system functions.

Smatrix Move supply water controls regulate the supply water temperature that is provided by the primary energy source. Optimising the supply water temperature by adjusting predefined setpoints in correlation to outdoor temperatures. Smatrix Move can be used for both, heating and cooling. Additionally, the controller can communicate with a room thermostat, thus being able to include indoor temperatures in its calculation.

In cooling, the Smatrix Move supply water control also provides a high protection to avoid condensation. The predefined cooling curve of the system is adapted according to the relative room humidity in a reference room, reducing the cooling energy as needed to prevent condensation.

The Uponor Smatrix Move PRO Controller is a flexible, installer-friendly and versatile multi-zone supply water controller. Designed mainly for managing Indoor Climate in commercial buildings, this controller fits different scenarios such as indoor and outdoor applications, radiant heating and cooling, domestic hot water, snow melt, and many more.

Premium user comfort and system functionalities

Uponor Smatrix Base Pulse and Wave Pulse

Uponor Smatrix Base Pulse and Uponor Smatrix Wave Pulse, flagships of the Smatrix room controls, features a mobile app interface and additional comfort and system functions:

- Comfort setting maintains the comfort by providing a warmed floor even if alternative heat sources are in use.
- Trend visualisation display graphs and diagrams that compare temperature settings room by room.
- System diagnostics identifies difficulties in reaching comfortable temperature levels and provides respective notifications.
- Room bypass ensures the necessary water flow for a heat pump even if a buffer tank is not integrated or is too small for the system.
- Mobile app interface for setup, configuration, monitoring (push notifications etc), and operation.

The Uponor Smatrix Pulse app provides an extra plus in user comfort, energy-efficiency, and flexibility. The app can be used on both smartphones and tablets (iOS or Android), and communicates with the communication module (which in turn communicates with the room controller) over Wi-Fi or internet (requires connection to Uponor Cloud services).

The Uponor Smatrix Pulse app makes it possible to easily setup, configure and operate your Uponor heating and cooling system (read room temperatures, switch between heating/cooling, Home/Away (sets the system to comfort/ECO), comfort/ECO, change room temperature setpoints, check the weather forecast, etc). The user is

also provided with in-app help texts, explaining the settings in detail and removing the need of a manual (which also is available in the app).

Uponor Smatrix Base PRO

Uponor Smatrix Base PRO, flagship of the non residential Smatrix room controls, features a touch screen interface and additional comfort and system functions:

- Comfort setting maintains the comfort by providing a warmed floor even if alternative heat sources are in use.
- Trend visualisation uses the touchscreen interface to display graphs and diagrams that compare temperature settings room by room.
- System diagnostics identifies difficulties in reaching comfortable temperature levels and provides respective notifications.
- Room check detects whether the thermostats are properly assigned to the heating or cooling circuits. This function is only available to Base PRO systems with less than 5 controllers.
- Room bypass ensures the necessary water flow for a heat pump even if a buffer tank is not integrated or is too small for the system.
- Building Management System (BMS) integration using a KNX-module.

Benefits for homeowners, installers and planners alike

Uponor's Smatrix line offers the ideal controls for homeowners, installers and planners alike. Homeowners benefit from optimal comfort and energy savings, installers can save time during installation and commissioning, and planners will find the right solution for any building project.

To learn more about the Smatrix product line please visit www.uponor.com/smatrix.

2 Room control - Functions

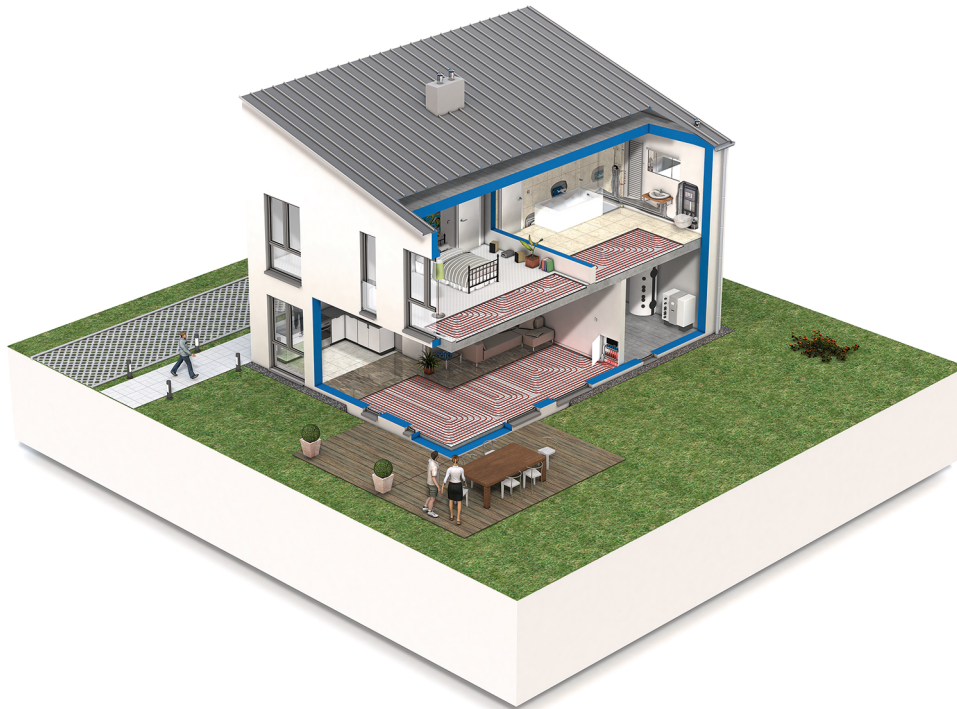

This list show available functions for the different systems. All functions are described later in this chapter.

| Basic Functions | Wave Pulse | Base Pulse | Base PRO |
|--|------------|------------|----------|
| Autobalancing | ✓ | ✓ | ✓ |
| Cooling function | ✓ | ✓ | ✓ |
| Modularity | ✓ | ✓ | ✓ |
| Installation and configuration functions | Wave Pulse | Base Pulse | Base PRO |
| Installation wizard | ✓ | ✓ | |
| Offline configuration | ✓ | ✓ | |
| Over-the-air updates | ✓ | ✓ | |
| Third-party remote support | ✓ | ✓ | |
| Comfort function | Wave Pulse | Base Pulse | Base PRO |
| Mobile app | ✓ | ✓ | |
| Smart notifications | ✓ | ✓ | |
| Trend visualization | ✓ | ✓ | ✓ |
| Multi home control | ✓ | ✓ | |
| Smart home integration | ✓ | ✓ | |
| Comfort settings | ✓ | ✓ | ✓ |
| ECO profiles | ✓ | ✓ | ✓ |
| Electrical underfloor heating control | ✓ | ✓ | |
| Ventilation integration | ✓ | ✓ | |
| Fan coil integration | ✓ | | |

| Technical function | Wave Pulse | Base Pulse | Base PRO |
|-----------------------|------------|------------|----------|
| Uponor cloud services | ✓ | ✓ | |
| Data storage | ✓ | ✓ | ✓ |
| Pump management | ✓ | ✓ | ✓ |
| System diagnostics | ✓ | ✓ | ✓ |
| HP integration | | | ✓ |
| Room bypass | ✓ | ✓ | ✓ |
| Room check | | | ✓ |
| BMS integration | | | ✓ |
| SMS module | | | ✓ |

2.1 Basic functions

Autobalancing



Note

Autobalancing can be used in combination with hydronic balancing.

The Uponor Smatrix room controller can operate the actuator outputs by either on/off signals or by Autobalancing (on by default), using pulse width modulation (PWM) signals.

Autobalancing is a function where the system calculates the actual energy need of single rooms and adapts the output power of each loop to its length. This means a short loop might get 20% on time while a long loop might get about 60%.

The automatic balancing continues through the seasons and throughout the household's changing lifestyle and usage patterns, removing the need of manual balancing.

This gives more even floor temperatures and faster system reaction times with lower energy consumption than any standard on/off system.

While manual hydraulic balancing only takes account of initial conditions, the autobalancing function automatically adjusts the temperature changes in the system or room without any need for complex re-calculation or adjustment by the installer.

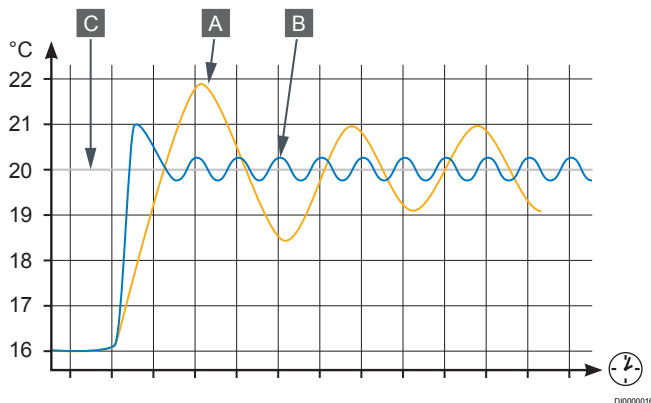

- A Manual balancing
- B Autobalancing
- C Set point value

Cooling function

Uponor Smatrix Base Pulse and Wave Pulse

The room controller operates the underfloor cooling installation according to customer needs. Temperatures can be adjusted with thermostats located in each room, or if installed with the Uponor Smatrix Pulse app (requires communication module).

As soon as the temperature measured at a thermostat is higher than the setpoint temperature, a demand to change the room temperature is created and sent to the room controller. The room controller will open the actuators according to current operating mode and other settings. If autobalancing is disabled, the actuators will open before the setpoint is reached. Once the set temperature is reached, this information is sent and the actuators are closed.

Uponor Smatrix Pulse app (requires communication module)

The system supports different types of cooling methods and is setup in the Uponor Smatrix PULSE app.

Available cooling methods in the Uponor Smatrix Pulse app.

- Underfloor cooling (UC)
Cooling in the system is achieved using underfloor loops.
- Fancoil (FC)
Cooling in the system is achieved using fancoils (connected to a relay module registered to a room thermostat).
Note! Autobalancing (Installer settings) should be disabled in the system.
In rooms where underfloor cooling is allowed and a fancoil is installed, underfloor cooling is started when the room temperature is a couple of degrees below setpoint (1st stage), and the fancoil is started at setpoint (2nd stage cooling).
- Ceiling cooling (CC)
Cooling in the system is achieved using ceiling cooling (2-pipe or 4-pipe system).
Select if the system utilizes a 2-pipe or 4-pipe delivery solution for heating/cooling.
 - 2-pipe means one supply temperature to the system at a time (heating or cooling).

Autobalancing disabled: In rooms where underfloor heating/cooling is allowed. Underfloor cooling and ceiling cooling is both started when the room temperature is about 1 degree below setpoint.

Autobalancing enabled: Ceiling cooling and underfloor cooling will follow the current cooling demand.

- 4-pipe means separate independent heating/cooling sources.
In heating mode:
The underfloor loops are used when there is a heating demand.
In cooling mode:
Underfloor loops and ceiling cooling are used at the same time when there is a cooling demand.

See Uponor Smatrix PULSE app for more information about the individual functions.

Supported installations

The different cooling methods can be combined in different ways.

- Underfloor heating and cooling
- Underfloor heating and ceiling cooling (2-pipe)
- Underfloor heating/cooling and ceiling cooling (2-pipe)
- Underfloor heating and ceiling cooling (4-pipe)
- Underfloor heating and fancoils¹⁾
- Underfloor heating/cooling and fancoils¹⁾

1) Uponor Smatrix Wave Pulse only.

Time delayed second stage cooling with relay module (requires communication module)

Using the relay module M-161, and a digital thermostat, an optional second cooling stage can be connected to the Wave Pulse controller.

Using one of the relays, activation of the second cooling stage is delayed either 30 minutes (relay 1) or 90 minutes (relay 2).

Uponor Smatrix Base PRO

The room controller operates the underfloor cooling installation according to customer needs. Temperatures can be adjusted with thermostats located in each room, with the touch screen interface (if installed), or via KNX (requires a KNX gateway module).

As soon as the temperature measured at a thermostat is higher than the setpoint temperature, a demand to change the room temperature is created and sent to the room controller. The room controller will open the actuators according to current operating mode and other settings. Once the set temperature is reached, this information is sent and the actuators are closed.

Cooling and humidity

| |
|--|
| Note |
| The Base PRO room controller have basic cooling functionalities with fixed, default values, when used without a user interface (touch screen I-147). |

All Uponor Smatrix systems are "cooling ready". This means that the relative humidity can be measured in each room (using a compatible thermostat), the supply temperature can be controlled by the Smatrix Move using a cooling curve, and system settings control when to change between heating and cooling.

It is possible to use the same thermostat to control the ceiling cooling or underfloor heating/cooling in a zone. This is configured in the system settings. It is also possible to configure the cooling and humidity settings in accordance with the end customer's needs.

Modularity

The room controller is designed with the option of modular placement in mind. This means that all major parts are detachable and can be placed separately (some extra wiring may be required depending on placement).

2.2 Installation and configuration functions

Installation wizard

The Uponor Smatrix Pulse app contains an installation wizard which guides the installer/user throughout the installation and makes the setup an easy process.

Offline configuration

The built-in Wi-Fi access point within the R-208 module gives direct access to the installation via the Uponor Smatrix Pulse app without the need of a router or internet connection.

Over-the-air updates

Uponor cloud services provide software updates for Uponor Smatrix Pulse systems. Once the cloud connection is established users will get a push notification on their mobile device as soon as updates are available for installation. This requires automatic system software update to be activated in the Uponor Smatrix Pulse app.

Third-party remote support

Users can authorize access to their system via the Uponor Smatrix Pulse app. This allows, e.g. installers to remotely access the users system for maintenance.

2.3 Comfort functions

Mobile app

The Uponor Smatrix Pulse app provides an extra plus in user comfort, energy-efficiency, and flexibility. The app can be used on both smartphones and tablets (iOS or Android), and communicates with the communication module (which in turn communicates with the room controller) over Wi-Fi or internet (requires connection to Uponor Cloud services).

The Uponor Smatrix Pulse app makes it possible to easily setup, configure and operate your Uponor heating and cooling system (read room temperatures, switch between heating/cooling, Home/Away (sets the system to comfort/ECO), comfort/ECO, change room temperature setpoints, check the weather forecast, etc). The user is also provided with in-app help texts, explaining the settings in detail and removing the need of a manual (which also is available in the app).

Smart notifications

Users can configure the Uponor Smatrix Pulse app to send push notifications as soon as there is an alarm in the system.

Trend visualization

The trend visualization shows temperature and utilisation trends for the week, for all rooms. In addition, it provides an energy consumption indication for the same period.

Multi home control

The Uponor Smatrix Pulse app allows users to get remote access to multiple Uponor Smatrix Pulse systems (no limit on number of systems). This way it is possible to configure and operate multiple installations, e.g. holiday homes, at anytime from anywhere.

Smart home integration

Uponor cloud services enables connectivity from an external system to the Uponor Smatrix Pulse system using an Application Programming Interface (API). An external system can be a heat pump, a third party smart home system, or a voice control assistant (such as Amazon Alexa and Google Assistant) etc.

Comfort setting

With the comfort setting, the system maintains a basic level of comfort for the room when there is no demand for heating. It will shorten the heat up time for the room, which is useful in rooms where other heating sources, e.g. a fireplace, is present.

ECO profiles

ECO profiles provides users the possibility to create individual room, or system wide, Comfort/ECO schedules in the systems connected to Uponor cloud services.

Electrical underfloor heating control

Uponor Smatrix Pulse provides wired integration to electrical underfloor heating by using an actuator outlet of an Uponor Smatrix Pulse controller.

Ventilation integration

Using a contact sensing input the Uponor Smatrix Pulse system provides the possibility to switch on (relay closed) and off (relay open) ventilation devices in order to increase the ambient comfort.

Fan coil integration

Using Uponor Smatrix Wave relay modules, fan coils can be easily integrated into the system and be used for cooling. The fan coils can be used either as stand-alone cooling devices, or in a two-stage cooling configuration (where fan coils are used as an cooling support when the performance of the installed radiant cooling is not sufficient).

2.4 Technical functions

Uponor cloud services

Uponor cloud services enables the system to be remotely controlled over internet by the Uponor Smatrix Pulse app, automatic room controller software updates, ECO scheduling, trend visualization, and the possibility of connecting to the system via an Application Programming Interface (API).

Data storage

Uponor Smatrix Pulse

System settings and data logging are stored in the cloud and are available via the Uponor Smatrix Pulse app, whenever required.

Uponor Smatrix Base PRO

Uponor Smatrix Base PRO uses a microSD card for cloning (interface settings), automatic backup (settings and thermostat

registration data), manual restoration of backup, data logging (room data, controller data, system data and events) and upgrading software.

Pump management

The circulation pump is connected either to the room controller relay or via a wireless relay module (Wave Pulse only).

Individual pump:

Relay function is set on a room controller basis. One circulation pump per room controller is connected to relay 1. When there is a demand to a specific room controller, only the pump connected to that room controller, or relay module (Wave Pulse only), is started.

Common pump:

Relay function is set on a system wide basis (up to four room controllers in one system). One pump per system is connected (to the master room controller relay 1 only, or the Wave Pulse only relay module). When there is a demand somewhere in the system, the main pump is started.

When set to Common, the circulation pump relay can be used for other functions on the sub room controller.

System diagnostics



Note

Uponor Smatrix Base Pulse and Wave Pulse systems must be connected to Uponor cloud services to utilize this function.

System diagnostics is a function which can be used to detect if the system supply temperature is optimal or not.

Activate this function to check whether the supply temperatures are too high or too low.

The result is displayed after roughly 24 hours as an alarm. Information on how to optimise the system is also displayed.

Heat pump (HP) integration



Note

This function is only available in Uponor Smatrix Base PRO systems with a maximum of four controllers.

The controller can connect to selected heat pumps (e.g. some NIBE heat pumps/indoor modules) and adjust the supply temperature to the system.

This function is only available in selected countries, contact a local Uponor office for more information.

Room bypass

Room bypass helps to increase the performance of a heat pump when a minimum flow is required, or if the buffer tank is too small for the system.

Time limit room bypass (Base Pulse and Wave Pulse only)

The time limit room bypass function prevents shorter run times than 30 minutes in the system. It does this by analyzing system data (if a room is close to a demand, setpoints, room temperatures etc) and chooses suitable rooms to use as bypass.

Room check



Note

In Base PRO systems, this function is only available to systems with less than 5 controllers.

This is a diagnostic function detecting whether a room thermostat is installed in the right room. The diagnostic function takes about 24hours per thermostat.

BMS integration

Uponor Smatrix Base PRO can be connected and integrated to a building management system (BMS) using a KNX-module.

SMS module

The SMS module provides the possibility for remote control (via SMS) to change between Comfort and ECO mode.

Additional features:

- Temperature readout and temperature alarms
- Alarm settings, phone number to send to and limits
- Parameter configuration

3 Supply water control - Functions

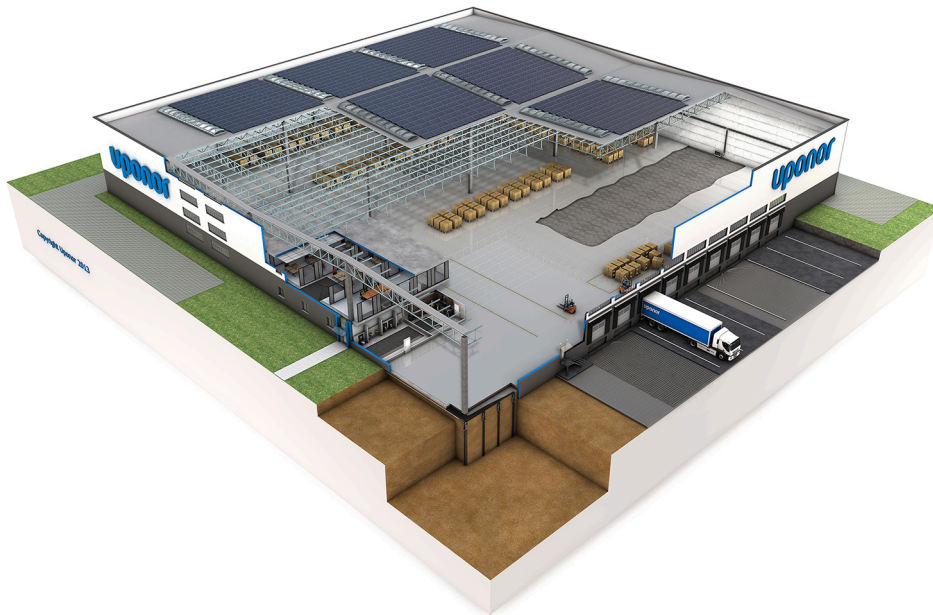

This list shows available functions for the different systems. All functions are described later in this chapter.

| Basic Functions | Move | Move PRO |
|-----------------------------|-----------------|----------|
| Multi zone management | | ✓ |
| Domestic hot water | ✓ | ✓ |
| Cooling function | ✓ | ✓ |
| Comfort function | Move | Move PRO |
| Step by Step setup wizard | ✓ | ✓ |
| Realtime status information | ✓ | ✓ |
| ECO settings | ✓ | ✓ |
| Technical function | Move | Move PRO |
| Data storage | | ✓ |
| Meltaway function | | ✓ |
| Room control integration | ✓ ¹⁾ | ✓ |
| Pump management | ✓ | ✓ |
| BMS integration | | ✓ |

1) Requires antenna and digital Wave room thermostat

radiators etc.), domestic hot water, or meltaway (snow melting) to keep large areas clear of snow.

Heating/cooling application

Using the heating/cooling application enables up to three zones to be setup for heating and/or cooling with different radiant systems (such as underfloor loops, ceiling panels etc.), domestic hot water, or meltaway (snow melting) to keep large areas clear of snow.

Domestic hot water

The system can be setup to regulate domestic hot water production.

Uponor Smatrix Move

The supply water controller regulates the domestic hot water temperature with an immersion thermostat placed in the domestic hot water tank.

Uponor Smatrix Move PRO

The supply water controller regulates the domestic hot water temperature by adjusting the water flow (mixing valve), controlling a circulation pump, and measuring the supply line and return line temperatures with sensors.

Cooling function

The system can be setup to switch between heating and cooling automatically, or manually, with relative humidity control. If an outdoor temperature sensor is connected a cooling curve can be used.

The cooling curve is used to calculate the supply temperature at specific outdoor temperatures. The curves are also limited by maximum and minimum parameters set in the system.

The choice of curve depends on a combination of different factors, such as how well insulated the house is, geographical location, type of heating/cooling system etc.

Example:

A poorly insulated house heated by a radiator system requires a higher curve value than an equivalent house with underfloor heating.

3.1 Basic functions

Multi zone management

Uponor Smatrix Move PRO is a supply temperature control system for use in different zones. The number of zones and setup vary depending on which application package (supplied with the controller) has been installed (inserting a microSD card into the controller).

Heating application

Using the heating application, enables up to four zones to be setup for heating with different radiant systems (such as underfloor loops,

Uponor Smatrix Move

Uponor Smatrix Move can switch between heating and cooling by integrating with an Uponor Wave Pulse system, using a physical heating/cooling switch connected to the supply water controller, or via a digital thermostat registered to the supply water controller (requires antenna A-155). These options cannot be combined in a Move system with a wireless thermostat, since the HC option in parameter 11, or 12, is disabled when a digital thermostat is registered to the supply water controller.

Uponor uses an Offset temperature to adjust the setpoints when switching between heating and cooling. This improves the performance of the system and reduces the need of manual setpoint adjustments when switching between heating and cooling. The default value is set to 2 °C and is used to increase the setpoint when switching to cooling. When switching back to heating, the setpoint is reduced.

Uponor Smatrix Move PRO

Uponor Smatrix Move PRO can, with the heating/cooling application installed, switch the different zones between heating and cooling in a number of different ways.

- Heating/cooling demand from integrated Uponor Smatrix Base PRO system.
- Indoor and outdoor temperatures.
- Supply water temperature.
- External (physical or signal) heating/cooling switch.
- Forced heating via software switch.
- Forced cooling via software switch.

A mandatory room temperature sensor and humidity sensor is placed in a reference room to enable indoor temperature setpoint parameters. It is used to keep the indoor temperature and relative humidity as close as possible to the setpoint.

3.2 Comfort functions

Step by Step setup wizard

Uponor Smatrix Move

The supply water controller initiates a startup wizard the first time it is started, or after a factory reset guiding the installer through all system settings. These settings can be accessed later when needed.

Uponor Smatrix Move PRO

The supply water controller initiates a startup wizard the first time it is started, or after a factory reset. This wizard is designed to configure the controller zones. Further settings can be done in the Settings menu.

It can also be started manually through the menu system.

Realtime status information

During normal operation current sensor data is shown on the display, in some cases heating/cooling demand etc. is also shown.

ECO settings

With the integrated timer in the supply water controller, it is possible to change the temperature setpoint modes between two different temperatures (Comfort and ECO mode).

The system can also switch between Comfort and ECO after receiving a signal from an intergrated Uponor Smatrix Base PRO (integrated to Uponor Smatrix Move PRO) or Uponor Smatrix Wave Pulse system (integrated to Uponor Smatrix Move).

3.3 Technical functions

Data storage

Uponor Smatrix Move PRO uses a microSD card for application selection (heating or heating/cooling), automatic backup of parameter settings, and manual restoration of backup.

Meltaway function

If a zone on the Uponor Smatrix Move PRO is setup as Meltaway, snow melting (keeping large areas clear of snow) is enabled in that zone. The supply temperature setpoint is calculated using an outdoor sensor, a ground temperature sensor, and a ground moisture sensor.

When to start or stop snow melting (status: Stop, Idle or Meltaway) is determined by using an outdoor temperature sensor, and two Uponor Smatrix Move PRO Sensor Snow S-158 sensors. One of the S-158 sensors is used for measuring the ground temperature and the other one is used for measuring the ground moisture level.

The return temperature sensor is used to calculate the difference between the supply and return temperature and trips an alarm if the difference is too high. A primary return sensor is used to protect the heat source from too low return temperatures.

Room control integration

Uponor Smatrix Move

Uponor Smatrix Move can, with a registered wireless thermostat (requires antenna A-155), be integrated with an Uponor Smatrix Wave system to enhance the capabilities of a full climate system. At the same time, the integration removes the need of a separate thermostat, and outdoor sensor, for the Move system.

Information regarding system state and reference room temperature is forwarded to the Move controller, which adjusts the supply temperature accordingly.

Different system states and temperatures which can be forwarded are:

- Comfort/ECO mode*
- Heating/cooling mode
- Temporary ECO*
- Reference room temperature and setpoint
- Outdoor temperature (if installed in the thermostat)
- Remote sensor (if installed in the thermostat)
- Indication if the relative humidity exceeds set limits (requires the digital thermostat T-168 or T-169, and the Uponor Smatrix Pulse app)

*) Through change of setpoint, using the ECO setback value from the integrated system. No indication or change of mode is shown in the Move controller.

Uponor Smatrix Move PRO

If a zone on the Uponor Smatrix Move PRO is setup as **Smatrix Base PRO**, individual room control in the zone is enabled via an integrated Uponor Smatrix Base PRO system. The supply temperature setpoint is calculated using sensor data and current mode from the Base PRO system.

Heating/cooling mode is set from the Smatrix Base PRO system.

The outdoor temperature sensor is connected to the Base PRO system via a thermostat, registered as a system device. The thermostat is preferably placed in a non-public area such as a technical room. The outdoor temperature sensor data will also be used by the other zones.

This requires the Move PRO controller to be connected to a Smatrix Base PRO bus.

A relative humidity sensor within the Smatrix Base PRO system is used to avoid condensation problems while in cooling mode.

Pump management

Uponor Smatrix Move

Uponor Smatrix Move can control a circulation pump according to current heating/cooling demand for the zone.

Uponor Smatrix Move PRO

| | |
|---|--|
|  | <p>Caution!</p> <p>The connection terminals are limited to 1A. An external relay might be needed.</p> |
|---|--|

Uponor Smatrix Move PRO can control a circulation pump according to current heating/cooling demands in up to 4 different zones with the heating application (3 different zones with the heating/cooling application).

BMS integration

Uponor Smatrix Move PRO can be connected and integrated to a building management system (BMS) through a Modbus-RTU interface over RS-232.

4 Room control - Component description

This section briefly describes some of the components in the Uponor Smatrix product family. For more detailed information and installation instructions, please see the installation and operation manuals for each system.

Application examples describing different installation possibilities are presented in the second half of this document. See *Application examples – Wave Pulse, Page 32*, *Application examples – Base Pulse, Page 51* or *Application examples – Move PRO, Page 65* (non residential with Base PRO) for more information.

4.1 Uponor Smatrix Pulse Communication module

| | |
|---|---|
| ! | Note The system can be setup without being connected to internet. |
| ! | Note Setting up a system with a communication module requires a mobile device (smart phone/tablet). |
| ! | Note It is recommended to attach the communication module to a wall outside of the cabinet when using Wi-Fi connection. |
| ! | Note It is recommended to attach the communication module to a wall outside of the cabinet when experiencing communication issues with Uponor Smatrix Wave thermostats. |

The communication module enables local and remote (requires connection to Uponor cloud services) access to the room controller from a mobile device (using the Uponor Smatrix Pulse app).

The communication module contains both an antenna module (for internal communication with thermostats and such), and a local network module for Wi-Fi or ethernet communication.

The app acts as a link between the user/installer and the room controller(s) running in the system, displaying information and enabling simplified programming of all relevant system settings. The

Uponor Smatrix Pulse app can be downloaded from Google Play (Android) or App Store (iOS).

The Uponor Smatrix Base Pulse or Wave Pulse system can be operated without the app and communication module, but only with basic functionality (using the thermostats).

Functions

Main characteristics:

- Uponor Smatrix Pulse app connectivity.
- Connection to router using either Wi-Fi or ethernet.
- Internal radio antenna for communication within the Uponor Smatrix system (eliminates the need for the regular antenna).
- Extra functionality (using Uponor Smatrix Pulse app):
 - Heating/cooling settings
 - Extra relay functionality (chiller, dehumidifier etc).
 - Integrate up to four room controller into one system.

Options:

- Cabinet or wall mounted (DIN rail or supplied screws).

Components of the communication module

The illustration below shows the communications module and its components.

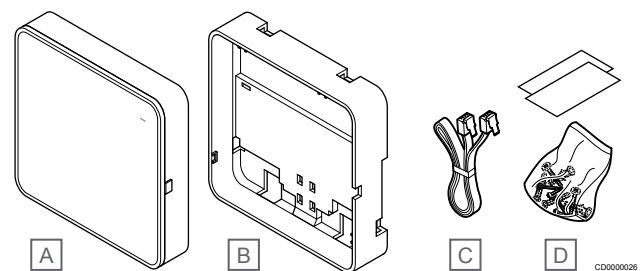

| Item | Description |
|------|----------------------------------|
| A | Uponor Smatrix PULSE Com R-208 |
| B | Optional back mount for DIN-rail |
| C | Communication cable |
| D | Mounting material |

4.2 Uponor Smatrix Wave Pulse

Cable specifications

| Cables | Standard cable length | Maximum cable length | Wire gauge |
|--|-----------------------|----------------------|---|
| Cable from room controller to antenna | 3 m | 5 m | CAT.5e or CAT.6, RJ 45 connector |
| Cable from room controller to communication module | 2 m | 5 m | CAT.5e or CAT.6, RJ 45 connector |
| Cable from room controller to actuator | 0.75 m | 20 m | Room controller: 0.2 mm ² to 1.5 mm ² |
| External sensor cable to thermostat | 5 m | 5 m | 0.6 mm ² |
| Floor sensor cable to thermostat | 5 m | 5 m | 0.75 mm ² |

| Cables | Standard cable length | Maximum cable length | Wire gauge |
|--|-----------------------|----------------------|--|
| Outdoor sensor cable to thermostat | - | 5 m | Twisted pair |
| Cable from relay switch to room controller GPI input | 2 m | 20 m | Room controller: Up to 4.0 mm ² solid, or 2.5 mm ² flexible with ferrules Relay: 1.0 mm ² to 4.0 mm ² |

Uponor Smatrix Wave Pulse X-265



Caution!
Only 24 V AC Uponor actuators are compatible with the room controller.

The room controller operates the actuators, which in turn affect the flow of the supply water, to change the indoor temperature using information transmitted from registered thermostats and system parameters.

Up to six channels and eight actuators can be operated by the room controller which is typically located near the hydraulic system manifolds.

The illustration below shows the room controller with the transformer module and actuators.

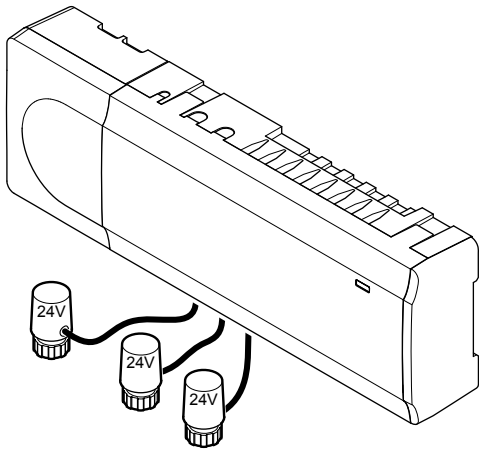

CD0000024

Functions

Main characteristics:

- Integrated Dynamic Energy Management functions such as autobalancing (on by default). Other functions such as comfort setting, room bypass, and supply temperature monitoring requires Uponor Smatrix Pulse app (requires communication module) and in some cases Uponor cloud services.
- Electronic control of actuators.
- Connection of maximum eight actuators (24 V AC).
- 2-way communication with up to six room thermostats.
- Heating/cooling function (advanced), and/or Comfort/ECO mode switched by dry contact, public thermostat, or Uponor Smatrix Pulse app (requires communication module).
- Separate relays for control of pump and boiler (other control functionality available via communication module and Uponor Smatrix Pulse app).
- Valve and pump exercise.
- Relative humidity control (Uponor Smatrix Pulse app required).
- Control of combined underfloor heating/cooling and ceiling cooling, or fancoils, (requires communication module and Uponor Smatrix Pulse app).
- Lower indoor temperature in heating mode, or raise indoor temperature in cooling mode, with ECO mode. ECO mode is activated in all rooms at once using a dry contact, public thermostat, or Uponor Smatrix Pulse app (requires communication module). To activate ECO mode in a single room use a programmable digital thermostat, or ECO profiles.

Options:

- App connectivity via communication module (remote connection requires connection to Uponor cloud services).
- The room controller can be expanded with a slave module which adds an extra six thermostat channels and six actuator outputs.
- Connect up to four room controllers into one system (requires communication module and the Uponor Smatrix Pulse app).
- Modular placement (detachable transformer).
- Cabinet or wall mounted (DIN rail or supplied screws).
- Free placement and orientation when installing the room controller (except the antenna/communication module which must be installed vertically).

Components of the room controller

The illustration below shows the room controller and its components.

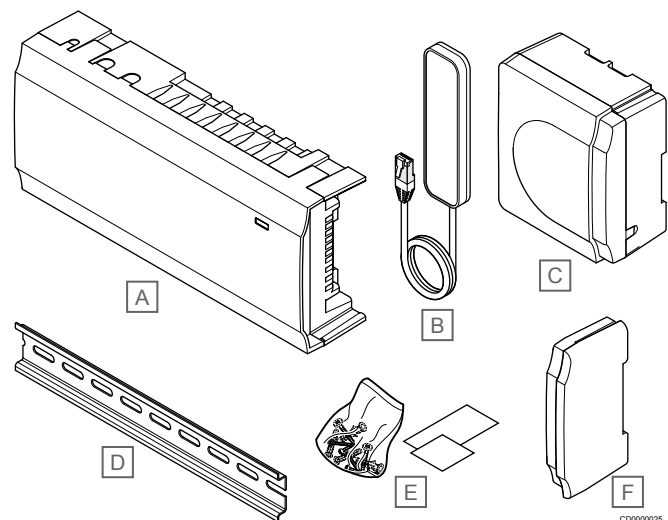

CD0000025

| Item | Description |
|------|---------------------------------|
| A | Uponor Smatrix Wave PULSE X-265 |
| B | Antenna |
| C | Transformer module |
| D | DIN rail |
| E | Mounting material |
| F | End cap |

Uponor Smatrix Wave Pulse M-262

The Uponor Smatrix Wave room controller can be expanded with six extra channels and actuator outputs using a Slave module.

Functions



Note
Only one slave module extension is supported per room controller.

Main characteristics:

- Easy plug in installation on existing room controller, no additional wiring needed.
- Register up to six extra thermostats to the system.

- Connect up to six extra actuators (24 V).
- Electronic control of actuators.
- Valve exercise.

Components of the slave module

The illustration below shows the slave module and its components.

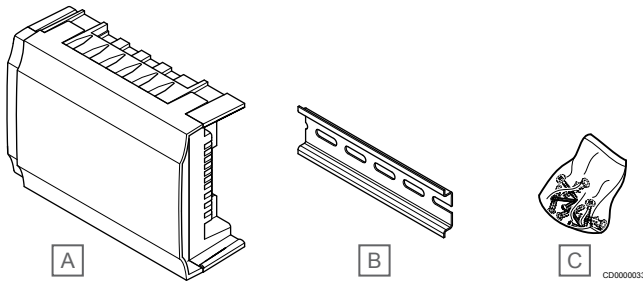

| Item | Description |
|------|---------------------------------|
| A | Uponor Smatrix Wave Pulse M-262 |
| B | DIN rail |
| C | Mounting material |

Uponor Smatrix Wave M-161

The relay module adds two extra output relays to the system.

Functions

Main characteristics:

- Potential free contacts (230 V AC, 5 A).
- Requires an Uponor Smatrix Wave room controller.
- Pump control and heating/cooling output function.

- Pump and dehumidifier control function (requires communication module and Uponor Smatrix Pulse app).
- Boiler and chiller control function (requires communication module and Uponor Smatrix Pulse app).
- Comfort/ECO and ventilation control function (requires communication module and Uponor Smatrix Pulse app).
- Fan coil control (requires communication module and Uponor Smatrix Pulse app for the fan coil to be linked to a room channel).
- Optional two stage cooling function (requires activation on the relay module, and the communication module).
- Can be placed up to 30 meters away from the room controller.

Components of the relay module

The illustration below shows the relay module and its components.

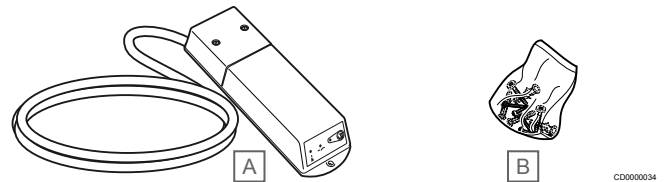

| Item | Description |
|------|---------------------------|
| A | Uponor Smatrix Wave M-161 |
| B | Mounting material |

Thermostats and sensors

See *Thermostats and sensors - Component description, Page 22* for information about compatible thermostats and sensors.

4.3 Uponor Smatrix Base Pulse

Cable specifications

| Cables | Standard cable length | Maximum cable length | Wire gauge |
|--|-----------------------|----------------------|--|
| Cable from room controller to communication module | 2 m | 5 m | CAT.5e or CAT.6, RJ 45 connector |
| Cable from room controller to actuator | 0.75 m | 20 m | Room controller: 0.2 mm ² to 1.5 mm ² |
| External sensor cable to thermostat | 5 m | 5 m | 0.6 mm ² |
| Floor sensor cable to thermostat | 5 m | 5 m | 0.75 mm ² |
| Outdoor sensor cable to thermostat | - | 5 m | Twisted pair |
| Cable from relay switch to room controller GPI input | 2 m | 20 m | Room controller: Up to 4.0 mm ² solid, or 2.5 mm ² flexible with ferrules Relay: 1.0 mm ² to 4.0 mm ² |

Uponor Smatrix Base PULSE X-245



Caution!
Only 24 V AC Uponor actuators are compatible with the room controller.

The room controller operates the actuators, which in turn affect the flow of the supply water, to change the indoor temperature using information transmitted from registered thermostats and system parameters.

Up to six channels and eight actuators can be operated by the room controller which is typically located near the hydraulic system manifolds.

The illustration below shows the room controller with the transformer module and actuators.

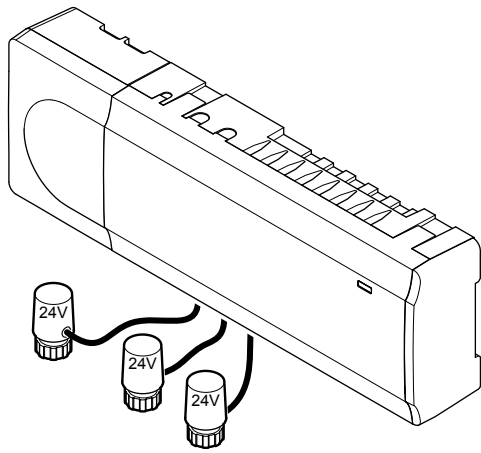

CD000024

Functions

Main characteristics:

- Integrated Dynamic Energy Management functions such as autobalancing (on by default). Other functions such as comfort setting, room bypass, and supply temperature monitoring requires Uponor Smatrix Pulse app (requires communication module) and in some cases Uponor cloud services.
- Electronic control of actuators.
- Connection of maximum eight actuators (24 V AC).
- 2-way communication with up to six room thermostats.
- Heating/cooling function (advanced), and/or Comfort/ECO mode switched by dry contact, public thermostat, or Uponor Smatrix Pulse app (requires communication module).
- Separate relays for control of pump and boiler (other control functionality available via communication module and Uponor Smatrix Pulse app).
- Valve and pump exercise.
- Relative humidity control (Uponor Smatrix Pulse app required).
- Control of combined underfloor heating/cooling and ceiling cooling (requires communication module and Uponor Smatrix Pulse app).
- Lower indoor temperature in heating mode, or raise indoor temperature in cooling mode, with ECO mode. ECO mode is activated in all rooms at once using a dry contact, public thermostat, or Uponor Smatrix Pulse app (requires communication module). To activate ECO mode in a single room use a programmable digital thermostat, or ECO profiles.

Options:

- App connectivity via communication module (remote connection requires connection to Uponor cloud services).
- The room controller can be expanded with a slave module which adds an extra six thermostat channels and six actuator outputs.
- The controller can be expanded with a star module which adds eight extra bus connectors to the system. It can be connected to the controller or slave module and is mostly used for a star topology.
- Connect up to four room controllers into one system (requires communication module and Uponor Smatrix Pulse app).
- Modular placement (detachable transformer).
- Cabinet or wall mounted (DIN rail or supplied screws).
- Free placement and orientation when installing the room controller (except the communication module which must be installed vertically).

Components of the room controller

The illustration below shows the room controller and its components.

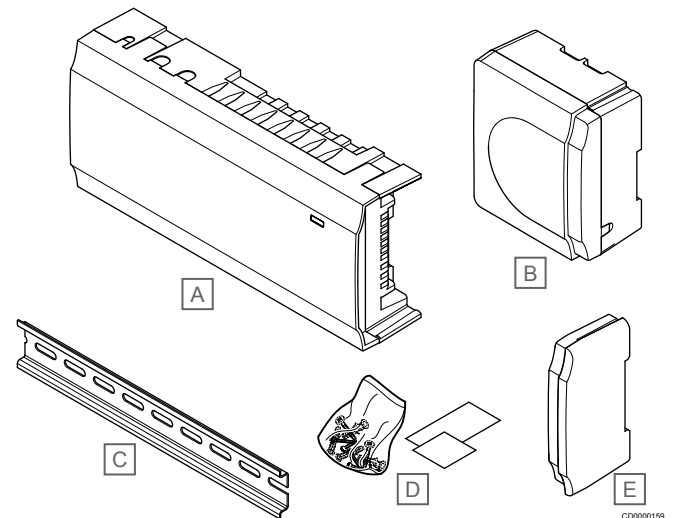

CD0000159

| Item | Description |
|------|---------------------------------|
| A | Uponor Smatrix Base PULSE X-245 |
| B | Transformer module |
| C | DIN rail |
| D | Mounting material |
| E | End cap |

Uponor Smatrix Base Pulse M-242

The Uponor Smatrix Base Pulse room controller can be expanded with six extra channels and actuator outputs using a Slave module.

Functions

Note

Only one slave module extension is supported per room controller.

Main characteristics:

- Easy plug in installation on existing room controller, no additional wiring needed.
- Register up to six extra thermostats to the system.
- Connect up to six extra actuators (24 V).
- Electronic control of actuators.
- Valve exercise.

Components of the slave module

The illustration below shows the slave module and its components.

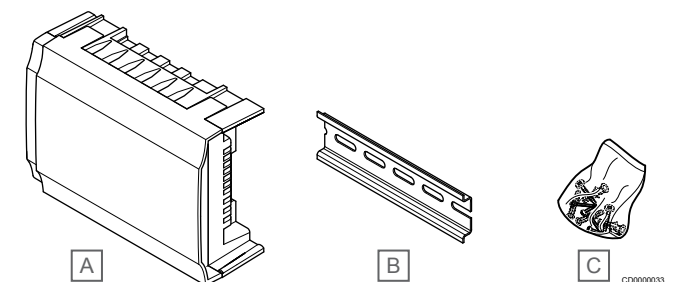

CD0000033

| Item | Description |
|------|---------------------------------|
| A | Uponor Smatrix Base Pulse M-242 |
| B | DIN rail |
| C | Mounting material |

Uponor Smatrix Base Pulse M-243

The Uponor Smatrix Base Pulse room controller can be expanded with a Star module if the thermostats is to be installed in a centralized star topology (instead of the standard bus topology).

Functions

Note

Only one star module extension per bus type (thermostat and/or system bus) is supported per room controller.

A star module can only be used for one bus type at a time. That is, a thermostat cannot be connected to a star module connected to the system bus and vice versa.

Main characteristics:

- Install the wiring from the thermostats in a centralized star topology (instead of a bus topology) which opens up for flexible wiring solutions.
- Requires an Uponor Smatrix Base Pulse controller.
- Adds 8 extra bus connectors to the system.
- Only thermostat input signals is allowed.
- Can be attached directly to the controller or slave module or by using a communication cable utilising one connector in each unit.

Components of the star module

The illustration below shows the star module and its components.

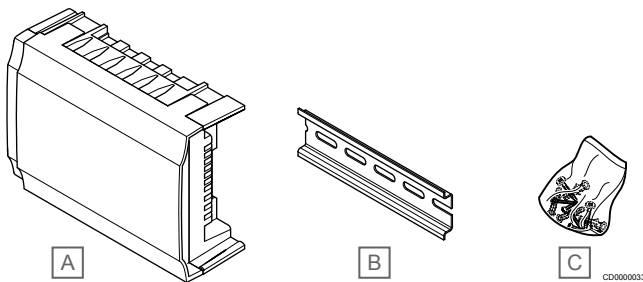

| Item | Description |
|------|---------------------------------|
| A | Uponor Smatrix Base Pulse M-243 |
| B | DIN rail |
| C | Mounting material |

Uponor Smatrix Base A-145

Bus cable for power supply and data transmission between the Smatrix Base Pulse/PRO room controllers and thermostats. It

includes added protection from interference fields generated by external electrical sources.

Consisting of two shielded colour coded pairs.

Functions

Main characteristics:

- Two wires for power supply
- Two wires for data transmission

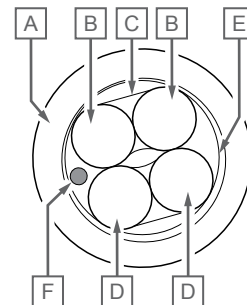
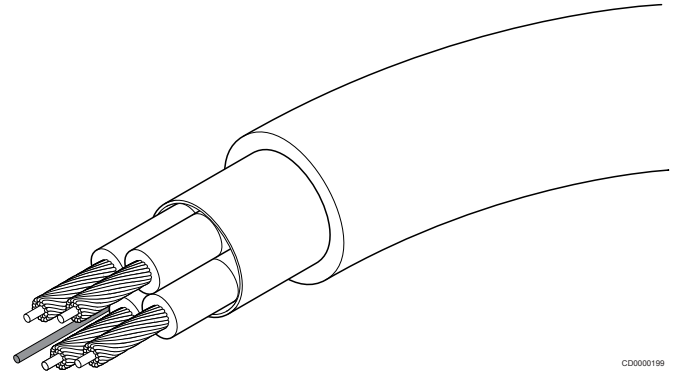

- A Jacket
- B Twisted core, Red/Black insulation
- C AL-mylar, inner foil shield
- D Twisted core, Green/White insulation
- E PET, outer shield
- F Pull string

Thermostats and sensors

See *Thermostats and sensors - Component description*, Page 22 for information about compatible thermostats and sensors.

4.4 Uponor Smatrix Base PRO

Cable specifications

| Cables | Standard cable length | Maximum cable length | Wire gauge |
|--|-----------------------|----------------------|---|
| Cable from room controller to actuator | 0.75 m | 20 m | Room controller: 0.2 mm ² to 1.5 mm ² |
| External sensor cable to thermostat | 5 m | 5 m | 0.6 mm ² |
| Floor sensor cable to thermostat | 5 m | 5 m | 0.75 mm ² |
| Outdoor sensor cable to thermostat | - | 5 m | Twisted pair |

| Cables | Standard cable length | Maximum cable length | Wire gauge |
|---|-----------------------|----------------------|--|
| Cable from relay switch to room controller GPI input | 2 m | 20 m | Room controller: Up to 4.0 mm ² solid, or 2.5 mm ² flexible with ferrules Relay: 1.0 mm ² to 4.0 mm ² |
| Cable to/from heat pump to room controller heat pump input/output | - | 30 m | Twisted pair |

Uponor Smatrix Base PRO X-147



Caution!

Only 24 V AC Uponor actuators are compatible with the room controller.

The room controller operates the actuators, which in turn affect the flow of the supply water, to change the indoor temperature using information transmitted from registered thermostats and system parameters.

Up to six channels and eight actuators can be operated by the room controller which is typically located near the hydraulic system manifolds.

The illustration below shows the room controller with the transformer module and actuators.

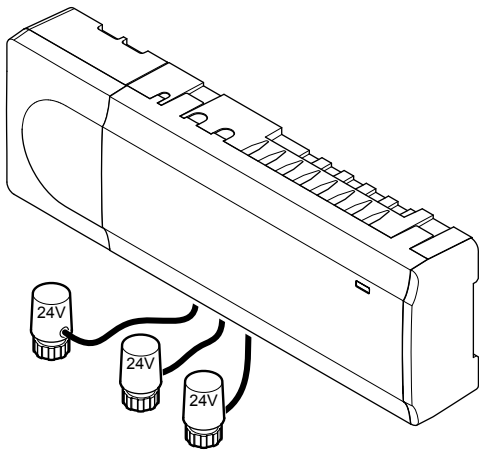

CD0000024

Functions

Main characteristics:

- Integrated Dynamic Energy Management functions such as autobalancing (on by default). Other functions such as comfort setting, room bypass, and supply temperature monitoring requires an interface.
- Electronic control of actuators.
- Connection of maximum eight actuators (24 V AC).
- 2-way communication with up to six room thermostats.
- Heating/cooling function (advanced) switched by dry contact, public thermostat (heating/cooling sensor only) or touch panel interface.
- Comfort/ECO mode switched by dry contact, public thermostat or touch panel interface.
- Separate relays for control of pump and boiler.
- Integrated heat pump module (only available in systems with four controllers or less, and in selected countries, contact a local Uponor office for more information).
- KNX connectivity via KNX module.
- Building Management System (BMS) integration using a KNX-module.
- Valve and pump exercise.
- Logging, back up and updates via microSD card.
- Relative humidity control (requires an interface).

- Control of combined underfloor heating/cooling and ceiling cooling (requires an interface).
- Lower indoor temperature in heating mode, or raise indoor temperature in cooling mode, with ECO mode. ECO mode is activated in all rooms at once using a dry contact, public thermostat, or interface. To activate ECO mode in a single room use a programmable digital thermostat, or ECO profiles.

Options:

- The room controller can be expanded with a slave module which adds an extra six thermostat channels and six actuator outputs.
- The room controller can be expanded with a star module which adds eight extra bus connectors to the system. It can be connected to the controller or slave module and is mostly used for a star topology.
- Connect up to 16 controllers into one system (requires an interface).
- Modular placement (detachable transformer).
- Cabinet or wall mounted (DIN rail or supplied screws).
- Free placement and orientation when installing the controller.

Components of the room controller

The illustration below shows the room controller and its components.

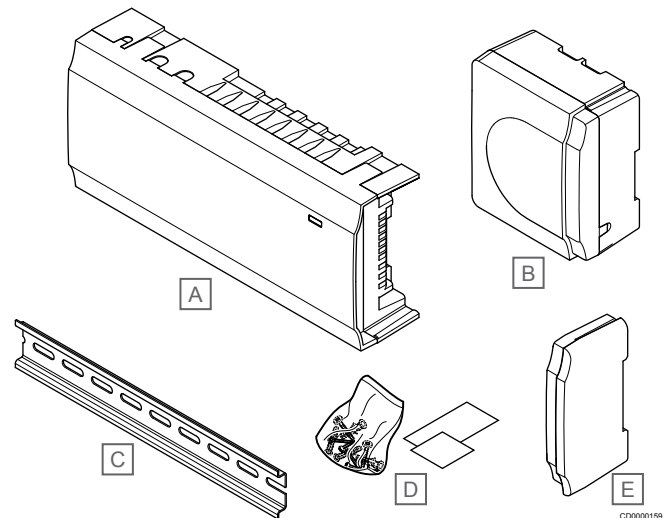

CD0000159

| Item | Description |
|------|-------------------------------|
| A | Uponor Smatrix Base PRO X-147 |
| B | Transformer module |
| C | DIN rail |
| D | Mounting material |
| E | End cap |

Uponor Smatrix Base PRO I-147



Note

Uponor Smatrix Base PRO systems without an interface can only operate with reduced functionality.

Uponor Smatrix Base PRO Interface I-147 is a touch screen interface which communicate with the X-147 controller by a wired communication protocol.

The interface acts as a link between the user and the controller(s) running in the system, displaying information and enabling simplified programming of all relevant system settings.

The Uponor Smatrix Base PRO system can be operated without the interface, but with reduced functionality (in example: many of the main characteristics listed below cannot be used).

Functions

Main characteristics:

- Touch screen interface.
- Display information and change settings of up to 16 controllers running within one system.
- Adjust temperature setpoints of registered thermostats within the system.
- Installation setup wizard when installed for the first time or after a factory reset.
- User friendly menu system available in several different languages.
- Backlit display.
- Temperature setback programs for each connected thermostat.
- Limitations of maximum/minimum temperature.
- Schedule temporary lowering of setpoint during holiday.
- Automatic change between summer- and winter time.
- Diagnostic function detecting if a room thermostat is installed in the right room (room check). The function is only available in systems with four controllers or less.
- Possibility to automatically open up to two rooms per controller when other rooms are closed to maintain a minimum flow (room bypass).
- System diagnostic (alarms etc).
- Visualize trends by e.g. comparing setpoint with room temperature etc.
- Advanced cooling settings.
- Change language and/or update the software with microSD card.
- KNX connectivity (requires an external module).
- Control of accessories (outputs etc).

Components of the interface:

The illustration below shows the interface and its components.

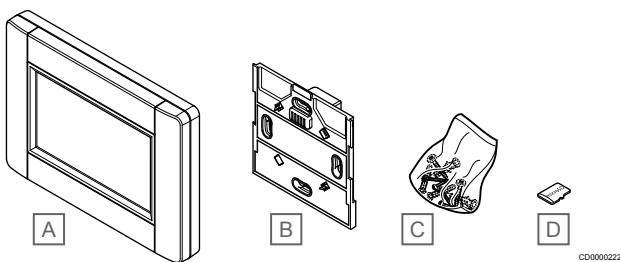

| Item | Description |
|------|--------------------------------|
| A | Uponor Smatrix Base PRO I-147 |
| B | Wall bracket with power supply |
| C | Mounting material |
| D | MicroSD card |

Uponor Smatrix Base M-140

The Uponor Smatrix Base PRO room controller can be expanded with six extra channels and actuator outputs using a Slave module.

Functions

Note

Only one slave module extension is supported per room controller.

Main characteristics:

- Easy plug in installation on existing room controller, no additional wiring needed.
- Register up to six extra thermostats to the system.
- Connect up to six extra actuators (24 V).
- Electronic control of actuators.
- Valve exercise.

Components of the slave module

The illustration below shows the slave module and its components.

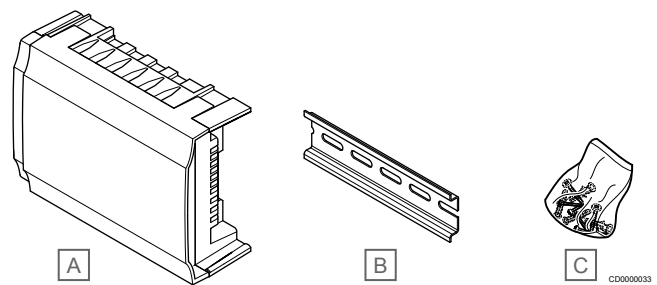

| Item | Description |
|------|---------------------------|
| A | Uponor Smatrix Base M-140 |
| B | DIN rail |
| C | Mounting material |

Uponor Smatrix Base M-141

The Uponor Smatrix Base PRO room controller can be expanded with a Star module if the thermostats is to be installed in a centralized star topology (instead of the standard bus topology).

Functions

Note

Only one star module extension per bus type (thermostat and/or system bus) is supported per room controller.

A star module can only be used for one bus type at a time. That is, a thermostat cannot be connected to a star module connected to the system bus and vice versa.

Main characteristics:

- Install the wiring from the thermostats in a centralized star topology (instead of a bus topology) which opens up for flexible wiring solutions.
- Requires an Uponor Smatrix Base PRO controller.
- Adds 8 extra bus connectors to the system.
- Only thermostat input signals is allowed.
- Can be attached directly to the controller or slave module or by using a communication cable utilising one connector in each unit.

Components of the star module

The illustration below shows the star module and its components.

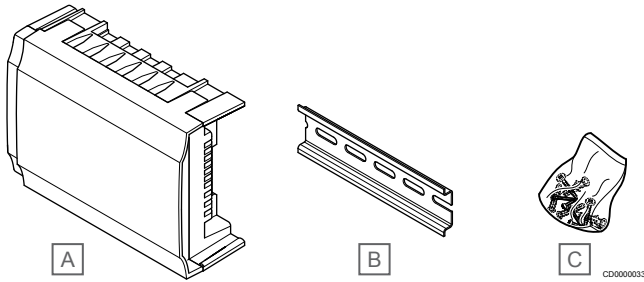

| Item | Description |
|------|---------------------------|
| A | Uponor Smatrix Base M-141 |
| B | DIN rail |
| C | Mounting material |

Uponor Smatrix R-56 SMS

The remote access module R-56 SMS is connected to the room controller via public thermostat T-143/T-163 registered as a system device (Comfort/ECO switch). When the internal relay in the remote access module is closed, the system is set to Forced ECO.

Functions

Main characteristics:

- Set the system to ECO mode remotely by sending an SMS.
- Set the system to Comfort mode remotely by sending an SMS, or by pressing a button on the SMS module.
- The SMS module can also be used with any other dry contact sensing input, i.e. heating/cooling, boiler on/off etc.
- Requires an Uponor Smatrix Wave/Base room controller.

Options:

- Temperature read out and alarms
- Parameter configuration

Uponor Smatrix Base PRO R-147 KNX

The KNX module enables communication between an Uponor Smatrix Base PRO system and a standard KNX bus.

Functions

Main characteristics:

- Enables usage of either Uponor or KNX thermostats in the system.
- Access to setpoints for every room.
- Access to readout of room and floor temperatures.
- Access to alarm monitoring.
- Access to heat curve in Uponor Smatrix Move PRO controller (if connected to a Base PRO system bus).
- Enables usage of standard KNX system for Comfort/ECO and heating/cooling switch.

Components of the KNX module

The illustration below shows the KNX module and its components.

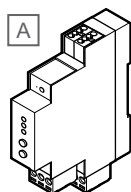

| Item | Description |
|------|-----------------------------------|
| A | Uponor Smatrix Base PRO R-147 KNX |

Uponor Smatrix Base A-145

Bus cable for power supply and data transmission between the Smatrix Base Pulse/PRO room controllers and thermostats. It includes added protection from interference fields generated by external electrical sources.

Consisting of two shielded colour coded pairs.

Functions

Main characteristics:

- Two wires for power supply
- Two wires for data transmission

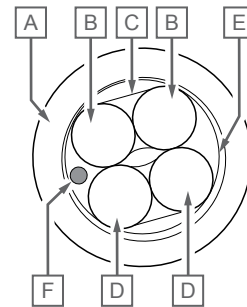
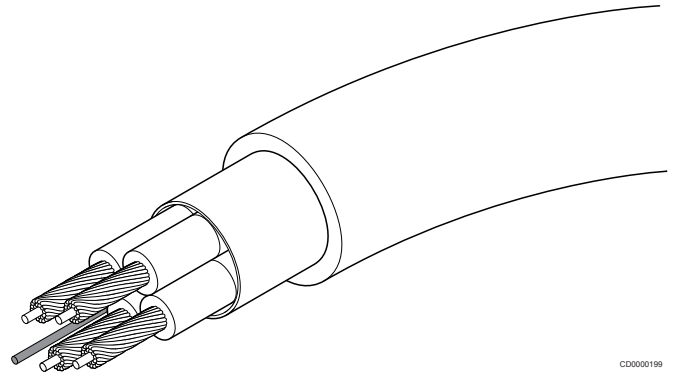

- A Jacket
- B Twisted core, Red/Black insulation
- C AL-mylar, inner foil shield
- D Twisted core, Green/White insulation
- E PET, outer shield
- F Pull string

Thermostats and sensors

See *Thermostats and sensors - Component description*, Page 22 for information about compatible thermostats and sensors.

5 Supply water control - Component description

This section briefly describes the some of the components in the Uponor Smatrix product family. For more detailed information and installation instructions, please see the installation and operation manuals for each system.

Application examples describing different installation possibilities are presented in the second half of this document. See *Application examples – Move, Page 63* or *Application examples – Move PRO, Page 65* for more information.

5.1 Uponor Smatrix Move

Uponor Smatrix Move X-157

| | |
|---|--|
|  | Caution! |
| | Only 230 V valve actuators are compatible with the controller. |

The controller operates the 3-way valve actuator and circulation pump, which in turn affect the flow of the supply water, to change both the supply and indoor temperatures.

The Uponor Smatrix Move X-157 is a controller which uses an outdoor temperature sensor, a supply temperature sensor, an optional return temperature sensor, and system parameters to regulate the system.

Functions

Main characteristics:

- Control of supply temperature to heating and/or cooling systems.
- Heating and cooling curve for outdoor compensation.
- 3-way valve control with status in display.
- 2-way valve control, special actuator, with status in display.
- Heating/cooling outputs for switchover valves.
- Circulation pump control with status in display.
- Scheduling, pre-programmed and customizable schedules.
- Outdoor temperature sensor, wired.
- Start/stop of heating source (boiler etc) and/or cooling source (chiller etc).
- Lower indoor temperature with night set back (ECO mode).

Options:

- Wall mounted (screws supplied).
- External antenna, which must be installed vertically.

Component of the supply temperature controller

The illustration below shows the supply temperature controller and its components.

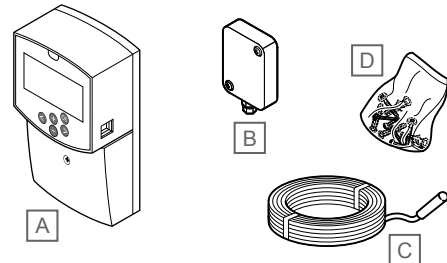

CD0000208

| Item | Description |
|------|---------------------------|
| A | Uponor Smatrix Move X-157 |
| B | Uponor Smatrix S-1XX |
| C | Uponor Smatrix Move S-152 |
| D | Mounting material |

Uponor Smatrix Move A-155

The antenna together with a wireless room thermostat adds more functionality to the Uponor Smatrix Move system.

Functions

Main characteristics:

- 1-way communication with a room thermostat (receive information from the thermostat).
- Control of supply temperature to cooling systems with relative humidity control.
- Outdoor temperature sensor, wireless (via a thermostat).
- System integration with an Uponor Smatrix Wave system.

Components of the antenna

The illustration below shows the antenna and its components.

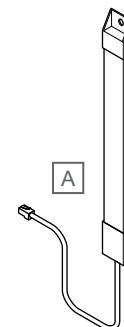

CD0000209

| Item | Description |
|------|--------------------|
| A | Smatrix Move A-155 |

Thermostats and sensors

See *Thermostats and sensors - Component description, Page 22* for information about compatible thermostats and sensors.

5.2 Uponor Smatrix Move PRO

Uponor Smatrix Move PRO X-159

Uponor Smatrix Move PRO is a supply temperature controller which operates the valve actuators and circulation pumps to affect the supply water temperature to the zone.

Functions

Heating application

Main characteristics:

- Integrated display with menu system.
- Control of supply temperature for up to four zones (up to four heating systems, up to two snow melting zones, and one domestic hot water zone).
- Heating curve (Stand Alone Control and Smatrix Base PRO zones only).
- Connection of maximum four actuators (one per zone).
- Connection of maximum four circulation pumps (one per zone).
- Pump exercise.
- Lower supply temperature using customizable schedules (ECO mode).
- Initial setup done via startup wizard.
- BMS ready via Modbus and KNX interfaces.
- Integration with Uponor Smatrix Base PRO via system bus.

Options:

- Cabinet or wall mounted using a DIN rail (not supplied).

Heating/cooling application

Main characteristics:

- Integrated display with menu system.
- Control of supply temperature for up to three zones (up to three heating systems, one snow melting zone, and one domestic hot water zone).
- Heating/cooling curve (Stand Alone Control and Smatrix Base PRO zones only).
- Connection of maximum three actuators (one per zone).
- Connection of maximum three circulation pumps (one per zone).
- Pump exercise.
- Lower supply temperature using customizable schedules (ECO mode).
- Initial setup done via startup wizard.
- BMS ready via Modbus and KNX interfaces.
- Integration with Uponor Smatrix Base PRO via system bus.

Options:

- Cabinet or wall mounted using a DIN rail (not supplied).

Components of the supply temperature controller

The illustration below shows the supply water controller and its components.

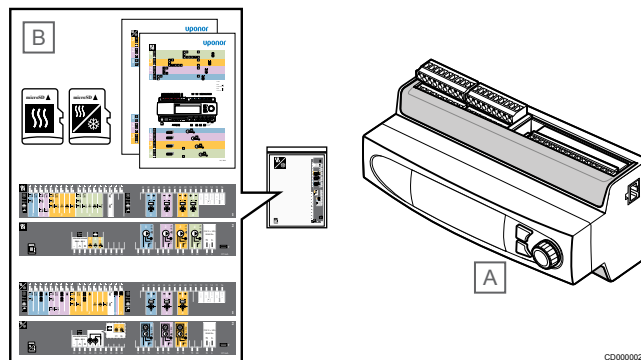

| Item | Description |
|------|---|
| A | Uponor Smatrix Move PRO X-159 |
| B | Application package (microSD card, application diagram, connection stickers) for heating, and heating/cooling applications. |







Thermostats and sensors

See *Thermostats and sensors - Component description*, Page 22 for information about compatible thermostats and sensors.

6 Thermostats and sensors - Component description

| | Uponor Smatrix Base PRO | Uponor Smatrix Base Pulse | Uponor Smatrix Wave Pulse | Uponor Smatrix Move (with antenna) | Uponor Smatrix Move PRO |
|-------------------------------|-------------------------|---------------------------|---------------------------|------------------------------------|-------------------------|
| Uponor Smatrix Move PRO S-155 | | | | | ✓ |
| Uponor Smatrix Move PRO S-157 | | | | | ✓ |
| Uponor Smatrix Move PRO S-158 | | | | | ✓ |
| Uponor Smatrix Move PRO S-159 | | | | | ✓ |
| Uponor Smatrix Base T-141 | ✓ | ✓ | | | |
| Uponor Smatrix Base T-143 | ✓ | ✓ | | | |
| Uponor Smatrix Base T-144 | ✓ | ✓ | | | |
| Uponor Smatrix Base T-145 | ✓ | ✓ | | | |
| Uponor Smatrix Base T-146 | ✓ | ✓ | | | |
| Uponor Smatrix Base T-148 | ✓ | ✓ | | | |
| Uponor Smatrix Base T-149 | ✓ | ✓ | | | |
| Uponor Smatrix Wave T-161 | | | ✓ | | |
| Uponor Smatrix Wave T-162 | | | ✓ | | |
| Uponor Smatrix Wave T-163 | | | ✓ | ✓ | |
| Uponor Smatrix Wave T-165 | | | ✓ | | |
| Uponor Smatrix Wave T-166 | | | ✓ | ✓ | |
| Uponor Smatrix Wave T-168 | | | ✓ | ✓ | |
| Uponor Smatrix Wave T-169 | | | ✓ | ✓ | |

6.1 Uponor Smatrix Wave

| |  |  |  |  |  |  |  |
|--|---|---|---|---|---|---|---|
| Wave | T-161 | T-162 | T-163 | T-165 | T-166 | T-168 | T-169 |
| Clock and date (display/setting) | | | | | | ✓ | |
| Programmable Comfort/ECO schedules (6 fixed + 1 custom) | | | | | | ✓ | |
| Comfort/ECO (indication and mode from system setting) | | ✓ | | | ✓ | ✓ | ✓ |
| Digital display | | ✓ ¹⁾ | | | ✓ ¹⁾ | ✓ ¹⁾ | ✓ |
| Low battery indication | ✓ | ✓ | ✓ | ✓ | ✓ | ✓ | ✓ |
| Software version at power up | | ✓ | | | ✓ | ✓ | ✓ |
| Control mode settings in display ²⁾ | | | | | ✓ | ✓ | ✓ |
| Dip switch settings for control mode, or system setting ³⁾ | | | ✓ | | | | |
| Celsius/Fahrenheit in display | | ✓ | | | ✓ | ✓ | ✓ |
| ECO setback value | ✓ ⁶⁾ | ✓ | ✓ ⁶⁾ | ✓ ⁶⁾ | ✓ | ✓ | ✓ |
| Setpoint adjustment using buttons | | ✓ | | | ✓ | ✓ | ✓ |
| Setpoint adjustment using dial | | | ✓ ⁵⁾ | ✓ ⁷⁾ | | | |
| Set point range 5 – 35 °C | ✓ ⁶⁾ | ✓ | ✓ | ✓ | ✓ | ✓ | ✓ |
| Cooling allowed | ✓ | | ✓ | ✓ | ✓ | ✓ | ✓ |
| Manual H/C switchover function | | | | | ✓ | ✓ | ✓ |
| External temperature sensor connection (floor, room, outside, or remote temperature) | ✓ ⁴⁾ | | ✓ | | ✓ | ✓ | ✓ |

| Wave | T-161 | T-162 | T-163 | T-165 | T-166 | T-168 | T-169 |
|---|-------|-------|-------|-------|-------|-------|-------|
| Heating or cooling demand indication | | ✓ | | ✓ | ✓ | ✓ | ✓ |
| Connection distance 30 m radio | ✓ | ✓ | ✓ | ✓ | ✓ | ✓ | ✓ |
| Relative humidity sensor | ✓ | | | | | ✓ | ✓ |
| Blue light indication behind dial after changing of set point | | | | ✓ | | | |
| Dip switch to enable or disable timer functions | | | ✓ | ✓ | | | |
| Tamper alarm | | | ✓ | | | | |
| Flush mounted | | | | | | | |

1) Backlight after button press

2) Available control modes: Room temperature (RT), RT with floor min./max. (FT), remote sensor (FS), remote outdoor sensor (RO)

3) Available DIP-switch control modes: Room temperature, RT with floor min./max., remote sensor, remote outdoor sensor, outdoor temperature, remote switch H/C, supply temperature sensor H/C switch, Comfort/ECO switch

4) T-161 with floor temperature sensor only

5) Potentiometer placed on its back

6) Requires user interface (Wave Pulse: Uponor Smatrix Pulse app).

7) Blue LED indication

Uponor Smatrix Wave T-161

Note

The thermostat wall bracket is not compatible with standard wall boxes for electrical installation.

The sensor thermostat is designed to be as small as possible, and still able to control the room temperature.

Functions

Main characteristics:

- Operative sensor for increased comfort.
- Adjust setpoint temperature via the Uponor Smatrix Pulse app (requires communication module).
- Setpoint range is 5 – 35 °C (maximum and minimum setting may be limited by other system settings).
- Optional floor temperature sensor can be connected to the thermostat. Floor temperature limitation settings (maximum and minimum) are only available using the Uponor Smatrix Pulse app (requires communication module). Otherwise system defaults are used to limitation.
- Relative humidity limit indicated in the Uponor Smatrix Pulse app (requires communication module).
- Can be placed up to 30 meters away from the room controller.

Components of the sensor thermostat:

The illustration below shows the thermostat and its components.

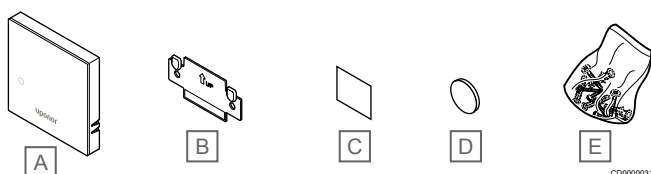

| Item | Description |
|------|---------------------------|
| A | Uponor Smatrix Wave T-161 |
| B | Wall bracket |

| Item | Description |
|------|---------------------|
| C | Adhesive tape |
| D | Battery (CR2032 3V) |
| E | Mounting material |

Uponor Smatrix Wave T-162

The thermostatic head enables control of radiators in the system.

Functions

Main characteristics:

- Proportional control
- Backlit display, dims after 10 seconds of inactivity.
- Displays Celsius or Fahrenheit.
- Displays software version during power up sequence.
- Receives setpoint and Comfort/ECO mode from thermostat and Uponor Smatrix Pulse app (requires communication module), if available. The setpoint is otherwise set on the thermostatic head.
- Setpoint range is 5 – 35 °C (maximum and minimum setting may be limited by other system settings).
- Shows current room temperature.
- Requires an Uponor Smatrix Wave room controller.
- One to several thermostatic heads per room can be registered. Up to two thermostatic heads per channel.
- Can be placed up to 30 meters away from the room controller.

Components of the thermostatic head

The illustration below shows the thermostatic head and its components.

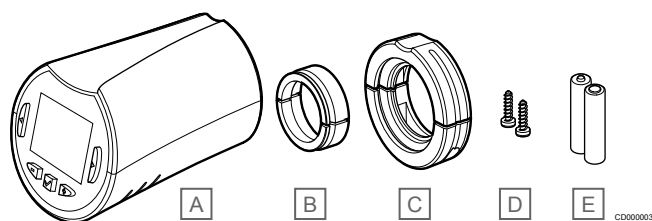

| Item | Description |
|------|---------------------------------|
| A | Uponor Smatrix Wave T-162 |
| B | Adaptors (threaded M30 and M28) |
| C | Plastic fitting brackets |
| D | Mounting screws |
| E | Batteries (AA 1.5 V) |

Uponor Smatrix Wave T-163

The thermostat is designed for public locations which means that the dial is hidden. It must be removed from the wall to set the temperature. When removed, an alarm is triggered (if activated).

The thermostat can be registered as a system device, enabling extra functions. When functioning as a system device, the internal room sensor is disabled.

Functions

Main characteristics:

- Adjust setpoint temperature with a potentiometer on the back of the thermostat.
- Setpoint range is 5 – 35 °C (maximum and minimum setting may be limited by other system settings).
- Alarm is indicated on the room controller if removed from wall for tamper detection. Using the Uponor Smatrix Pulse app (requires communication module), the alarm will be displayed in the app as well.
- Dry contact input for switching operation modes between heating and cooling, if registered as a system device.
- Dry contact input for forced ECO mode of operation, if registered as a system device.
- Optional floor temperature sensor can be connected to the thermostat. Floor temperature limitation settings (maximum and minimum) are only available using the Uponor Smatrix Pulse app (requires communication module). Otherwise system defaults are used to limitation.
- Optional outdoor temperature sensor can be registered as either standard thermostat or system device.
- Dip switch for selecting between function or sensor mode of operation.
- Enable or disable Comfort/ECO scheduling for the room with a dip switch on the back.
- Can be placed up to 30 meters away from the room controller.

Components of the thermostat:

The illustration below shows the thermostat and its components.

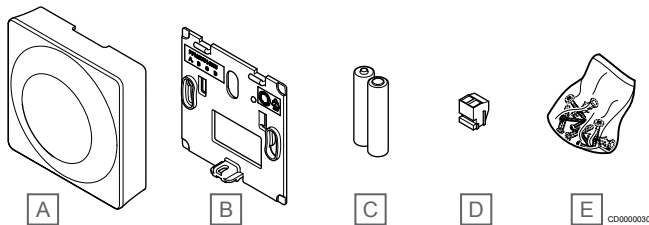

| Item | Description |
|------|---------------------------|
| A | Uponor Smatrix Wave T-163 |
| B | Wall bracket |
| C | Batteries (AAA 1.5 V) |
| D | Connection terminal |
| E | Mounting material |

Uponor Smatrix Wave T-165

The thermostat temperature settings are adjusted using the dial. Maximum/minimum temperatures can only be set using the Uponor Smatrix Pulse app (requires communication module). The 21 °C position is marked on the dial.

Functions

Main characteristics:

- Adjust temperature setpoint with large dial.

- LED ring indication when twisting the dial (changing temperature setpoint).
- Setpoint range is 5 – 35 °C (maximum and minimum setting may be limited by other system settings).
- LED in lower right corner indicating, for about 60 seconds, whether a heating or cooling demand exists.
- Enable or disable Comfort/ECO scheduling for the room with a dip switch on the back.
- Can be placed up to 30 meters away from the room controller.

Components of the thermostat:

The illustration below shows the thermostat and its components.

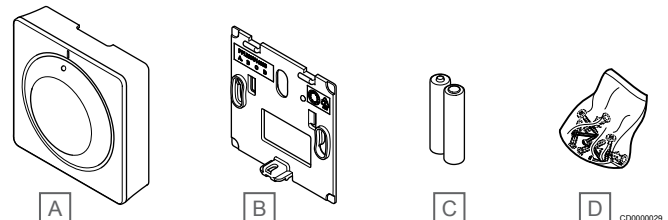

| Item | Description |
|------|---------------------------|
| A | Uponor Smatrix Wave T-165 |
| B | Wall bracket |
| C | Batteries (AAA 1.5 V) |
| D | Mounting material |

Uponor Smatrix Wave T-166

The thermostat shows the ambient, set temperature or relative humidity on the display. Temperature settings are adjusted using the +/- buttons on the front.

Functions

Main characteristics:

- Backlit display, dims after 10 seconds of inactivity.
- Displays Celsius or Fahrenheit.
- Calibration of displayed room temperature.
- Heating/cooling demand as well as low battery indication on display.
- Displays software version during power up sequence.
- Setpoint range is 5 – 35 °C (maximum and minimum setting may be limited by other system settings).
- Room temperature regulation with use of optional external temperature sensors.
- Displays optional temperature sensor values if sensors are connected and relevant room temperature regulation is activated.
- Switch between Comfort and ECO mode with scheduling (requires Uponor Smatrix PULSE app).
- Adjust ECO setback value.
- Can be placed up to 30 meters away from the room controller.

Components of the thermostat:

The illustration below shows the thermostat and its components.

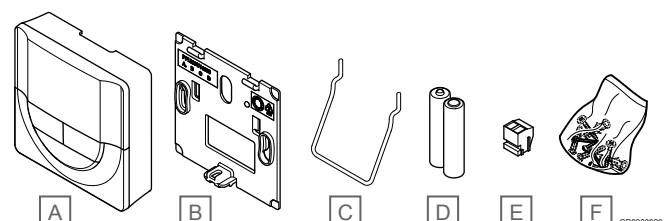

| Item | Description |
|------|---------------------------|
| A | Uponor Smatrix Wave T-166 |
| B | Wall bracket |
| C | Stand |
| D | Batteries (AAA 1.5 V) |
| E | Connection terminal |
| F | Mounting material |

Uponor Smatrix Wave T-168

The thermostat shows the ambient, set temperature, or relative humidity, and time on the display. Settings are adjusted using the +/- buttons on the front. Other programmable settings are scheduling and individual ECO mode (on a room by room basis) etc.

Uponor recommends only using this thermostat in systems without a communication module. The scheduling function in the thermostat is switched off in systems with a communication module.

Functions

Main characteristics:

- Backlit display, dims after 10 seconds of inactivity.
- Displays Celsius or Fahrenheit.
- Calibration of displayed room temperature.
- Heating/cooling demand as well as low battery indication on display.
- Displays software version during power up sequence.
- Setup wizard to set time and date when installed for the first time or after a factory reset.
- 12/24h clock for scheduling.
- Setpoint range is 5 – 35 °C (maximum and minimum setting may be limited by other system settings).
- Room temperature regulation with use of optional external temperature sensors.
- Displays optional temperature sensor values if sensors are connected and relevant room temperature regulation is activated.
- Programmable to switch between Comfort and ECO modes with adjustable ECO setback value in the room.
- When set to a program the T-168 cannot be overridden (ECO setback etc) by other system settings.
- Relative humidity limit alarm indicated in display (requires communication module).
- Scheduling, pre-programmed and customizable schedules.
- Lower indoor temperature on a room by room basis with ECO mode.
- Can be placed up to 30 meters away from the room controller.

Components of the thermostat:

The illustration below shows the thermostat and its components.

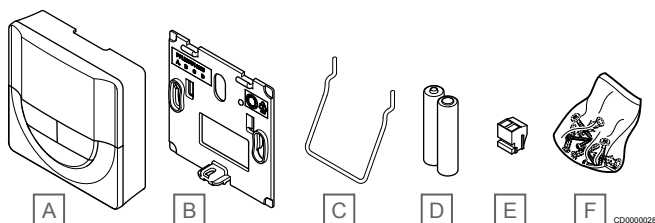

| Item | Description |
|------|---------------------------|
| A | Uponor Smatrix Wave T-168 |

| Item | Description |
|------|-----------------------|
| B | Wall bracket |
| C | Stand |
| D | Batteries (AAA 1.5 V) |
| E | Connection terminal |
| F | Mounting material |

Uponor Smatrix Wave T-169



Note

The thermostat wall bracket is not compatible with standard wall boxes for electrical installation.

The thermostat shows the ambient, set temperature, or relative humidity on the display. Temperature settings are adjusted using ▲/▼ buttons on the side of the thermostat.

Functions

Main characteristics:

- Power saving e-paper display (updates every 10 minutes).
- Displays Celsius or Fahrenheit.
- Operative sensor for increased comfort.
- Calibration of displayed room temperature.
- Heating/cooling demand as well as low battery indication on display.
- Displays Uponor logo and software version during power up sequence.
- Setpoint range is 5 – 35 °C (maximum and minimum setting may be limited by other system settings).
- Room temperature regulation with use of optional external temperature sensors.
- Displays optional temperature sensor values if sensors are connected and relevant room temperature regulation is activated.
- Switch between Comfort and ECO mode with scheduling (requires Uponor Smatrix PULSE app).
- Adjust ECO setback value.
- Relative humidity limit alarm indicated in display (requires communication module).
- Invert display color.
- Can be placed up to 30 meters away from the room controller.





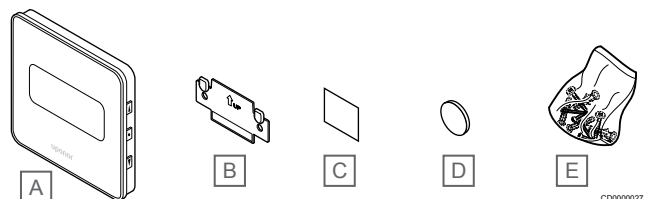

Components of the thermostat:

The illustration below shows the thermostat and its components.



| Item | Description |
|------|---------------------------|
| A | Uponor Smatrix Wave T-169 |
| B | Wall bracket |
| C | Adhesive tape |
| D | Battery (CR2032 3V) |
| E | Mounting material |

6.2 Uponor Smatrix Base

| |  |  |  |  |  |  |  |
|--|---|---|---|---|---|---|---|
| Base | T-141 | T-143 | T-144 | T-145 | T-146 | T-148 | T-149 |
| Clock and date (display/setting) | | | | | | ✓ | |
| Programmable Comfort/ECO schedules (6 fixed + 1 custom) | | | | | | ✓ | |
| Comfort/ECO (indication and mode from system setting) | | | | | ✓ | ✓ | ✓ |
| Digital display | | | | | ✓ ¹⁾ | ✓ ¹⁾ | ✓ |
| Software version at power up | | | | | ✓ | ✓ | ✓ |
| Control mode settings in display ²⁾ | | | | | ✓ | ✓ | ✓ |
| Dip switch settings for control mode, or system setting ³⁾ | | ✓ | | | | | |
| Celsius/Fahrenheit in display | | | | | ✓ | ✓ | ✓ |
| ECO setback value | ✓ ⁵⁾ | ✓ ⁵⁾ | ✓ ⁵⁾ | ✓ ⁵⁾ | ✓ | ✓ | ✓ |
| Setpoint adjustment using buttons | | | | | ✓ | ✓ | ✓ |
| Setpoint adjustment using dial | | ✓ ⁴⁾ | ✓ ⁶⁾ | ✓ ⁶⁾ | | | |
| Set point range 5 – 35 °C | ✓ ⁵⁾ | ✓ | ✓ | ✓ | ✓ | ✓ | ✓ |
| Cooling allowed | ✓ | ✓ | ✓ | ✓ | ✓ | ✓ | ✓ |
| Manual H/C switchover function | | | | | ✓ | ✓ | ✓ |
| External temperature sensor connection (floor, room, outside, or remote temperature) | | ✓ | | | ✓ | ✓ | ✓ |
| Heating or cooling demand indication | | | ✓ | ✓ | ✓ | ✓ | ✓ |
| Relative humidity sensor | ✓ | | | | | ✓ | ✓ |
| Blue light indication behind dial after changing of set point | | | ✓ | ✓ | | | |
| Dip switch to enable or disable timer functions | | ✓ | ✓ | ✓ | | | |
| Tamper alarm | | ✓ | | | | | |
| Flush mounted | | | ✓ | | | | |

1) Backlight after button press

2) Available control modes: Room temperature (RT), RT with floor min./max. (FT), remote sensor (FS), remote outdoor sensor (RO)

3) Available DIP-switch control modes: Room temperature, RT with floor min./max., remote sensor, remote outdoor sensor, outdoor temperature, remote switch H/C, supply temperature sensor H/C switch, Comfort/ECO switch

4) Potentiometer placed on its back

5) Requires user interface (Base Pulse: Uponor Smatrix Pulse app, Base PRO: Touch screen).

6) Blue LED indication

- Relative humidity limit indicated in the Uponor Smatrix Pulse app (requires communication module).

Components of the sensor thermostat:

The illustration below shows the thermostat and its components.

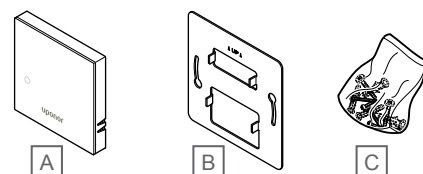

CD0000134

| Item | Description |
|------|---------------------------|
| A | Uponor Smatrix Base T-141 |
| B | Metal wall bracket |
| C | Mounting material |

Uponor Smatrix Base T-141

The sensor thermostat is designed to be as small as possible, and still able to control the room temperature.

Functions

Main characteristics:

- Operative sensor for increased comfort.
- Adjust setpoint temperature via the Uponor Smatrix Pulse app (requires communication module).
- Setpoint range is 5 – 35 °C (maximum and minimum setting may be limited by other system settings).

Uponor Smatrix Base T-143

The thermostat is designed for public locations which means that the dial is hidden. It must be removed from the wall to set the temperature. When removed, an alarm is triggered (if activated).

The thermostat can be registered as a system device, enabling extra functions. When functioning as a system device, the internal room sensor is disabled.

Functions

Main characteristics:

- Adjust setpoint temperature with a potentiometer on the back of the thermostat.
- Setpoint range is 5 – 35 °C (maximum and minimum setting may be limited by other system settings).
- Alarm is indicated on the room controller if removed from wall for tamper detection. Using the Uponor Smatrix Pulse app (requires communication module), the alarm will be displayed in the app as well.
- Dry contact input for forced ECO mode of operation, if registered as a system device.
- Optional external temperature sensor can be connected to the thermostat. Floor temperature limitation settings (maximum and minimum) are only available using the Uponor Smatrix Pulse app (requires communication module). Otherwise system defaults are used for limitation.
- Optional outdoor temperature sensor can be registered as either standard thermostat or system device.
- Dip switch for selecting between function or sensor mode of operation.
- Enable or disable Comfort/ECO scheduling for the room with a dip switch on the back.

Components of the thermostat:

The illustration below shows the thermostat and its components.

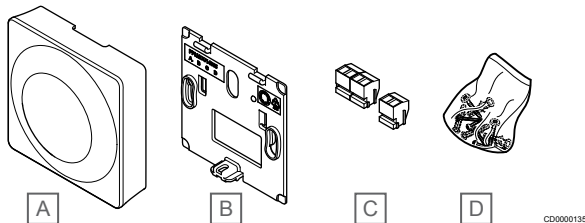

| Item | Description |
|------|---------------------------|
| A | Uponor Smatrix Base T-143 |
| B | Wall bracket |
| C | Connection terminals |
| D | Mounting material |

Uponor Smatrix Base T-144

The thermostat temperature settings are adjusted using the dial. Maximum/minimum temperatures can only be set using the Uponor Smatrix Pulse app (requires communication module). The 21 °C position is marked on the dial.

Functions

Main characteristics:

- Flush installation, specially designed for in-wall box installation.
- Adjust temperature setpoint with large dial.
- Printed scale on the dial.
- Setpoint range is 5 – 35 °C (maximum and minimum setting may be limited by other system settings).
- LED indicating, for about 60 seconds, whether a heating or cooling demand exists.
- Enable or disable Comfort/ECO scheduling for the room with a dip switch beneath the dial, which have to be removed for access.
- Different frames can be used for installation in a switch rail frame.

Components of the thermostat:

The illustration below shows the thermostat and its components.

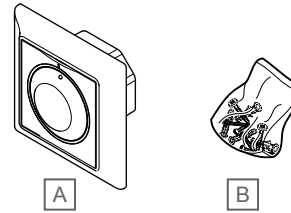

| Item | Description |
|------|---------------------------|
| A | Uponor Smatrix Base T-144 |
| B | Mounting material |

Uponor Smatrix Base T-145

The thermostat temperature settings are adjusted using the dial. Maximum/minimum temperatures can only be set using the Uponor Smatrix Pulse app (requires communication module). The 21 °C position is marked on the dial.

Functions

Main characteristics:

- Adjust temperature setpoint with large dial.
- LED ring indication when twisting the dial (changing temperature setpoint).
- Setpoint range is 5 – 35 °C (maximum and minimum setting may be limited by other system settings).
- LED in lower right corner indicating, for about 60 seconds, whether a heating or cooling demand exists.
- Enable or disable Comfort/ECO scheduling for the room with a dip switch on the back.

Components of the thermostat:

The illustration below shows the thermostat and its components.

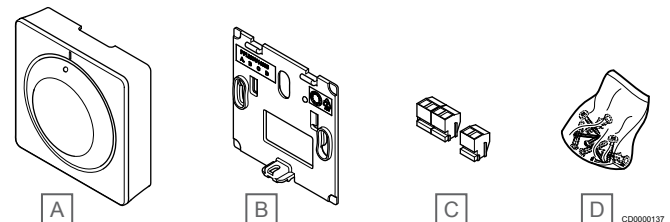

| Item | Description |
|------|---------------------------|
| A | Uponor Smatrix Base T-145 |
| B | Wall bracket |
| C | Connection terminals |
| D | Mounting material |

Uponor Smatrix Base T-146

The thermostat shows the ambient, set temperature or relative humidity on the display. Temperature settings are adjusted using the +/- buttons on the front.

Functions

Main characteristics:

- Backlit display, dims after 10 seconds of inactivity.
- Displays Celsius or Fahrenheit.
- Calibration of displayed room temperature.
- Heating/cooling demand on display.

- Displays software version during power up sequence.
- Setpoint range is 5 – 35 °C (maximum and minimum setting may be limited by other system settings).
- Room temperature regulation with use of optional external temperature sensors.
- Displays optional temperature sensor values if sensors are connected and relevant room temperature regulation is activated.
- Switch between Comfort and ECO mode with scheduling (requires Uponor Smatrix PULSE app).
- Adjust ECO setback value.

Components of the thermostat:

The illustration below shows the thermostat and its components.

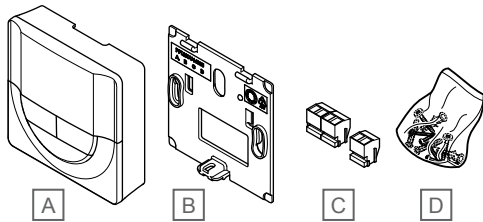

| Item | Description |
|------|---------------------------|
| A | Uponor Smatrix Base T-148 |
| B | Wall bracket |
| C | Connection terminals |
| D | Mounting material |

Uponor Smatrix Base T-148

The thermostat shows the ambient, set temperature, or relative humidity, and time on the display. Settings are adjusted using the +/- buttons on the front. Other programmable settings are scheduling and individual ECO mode (on a room by room basis) etc.

Uponor recommends only using this thermostat in systems without a communication module. The scheduling function in the thermostat is switched off in systems with a communication module.

Functions

Main characteristics:

- Backlit display, dims after 10 seconds of inactivity.
- Displays Celsius or Fahrenheit.
- Calibration of displayed room temperature.
- Heating/cooling demand on display.
- Displays software version during power up sequence.
- Setup wizard to set time and date when installed for the first time or after a factory reset.
- 12/24h clock for scheduling.
- Internal memory to save time and date settings during short power outages.
- Setpoint range is 5 – 35 °C (maximum and minimum setting may be limited by other system settings).
- Room temperature regulation with use of optional external temperature sensors.
- Displays optional temperature sensor values if sensors are connected and relevant room temperature regulation is activated.
- Programmable to switch between Comfort and ECO modes with adjustable ECO setback value in the room.
- When set to a program the T-148 cannot be overridden (ECO setback etc) by other system settings.
- Relative humidity limit alarm indicated in display (requires communication module).

- Scheduling, pre-programmed and customizable schedules.
- Lower indoor temperature on a room by room basis with ECO mode.

Components of the thermostat:

The illustration below shows the thermostat and its components.

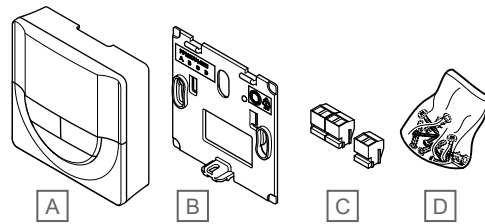

| Item | Description |
|------|---------------------------|
| A | Uponor Smatrix Base T-148 |
| B | Wall bracket |
| C | Connection terminals |
| D | Mounting material |

Uponor Smatrix Base T-149

The thermostat shows the ambient, set temperature, or relative humidity on the display. Temperature settings are adjusted using ▲/▼ buttons on the side of the thermostat.

Functions

Main characteristics:

- Power saving e-paper display (updates every 10 minutes).
- Displays Celsius or Fahrenheit.
- Operative sensor for increased comfort.
- Calibration of displayed room temperature.
- Heating/cooling demand on display.
- Displays Uponor logo and software version during power up sequence.
- Setpoint range is 5 – 35 °C (maximum and minimum setting may be limited by other system settings).
- Room temperature regulation with use of optional external temperature sensors.
- Displays optional temperature sensor values if sensors are connected and relevant room temperature regulation is activated.
- Switch between Comfort and ECO mode with scheduling (requires Uponor Smatrix PULSE app).
- Adjust ECO setback value.
- Relative humidity limit alarm indicated in display (requires communication module).
- Invert display color.

Components of the thermostat:

The illustration below shows the thermostat and its components.

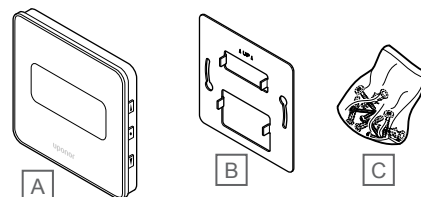

| Item | Description |
|------|---------------------------|
| A | Uponor Smatrix Base T-129 |
| B | Metal wall bracket |
| C | Mounting material |

6.3 Uponor Smatrix Move PRO

Uponor Smatrix Move PRO S-155

The sensor is designed to measure the indoor reference temperature within the zone.

The sensor is only used in zones setup as **Stand Alone Control**.

Functions

Main characteristics:

- Sensor range is 0 – 60 °C.
- Prepared for wall or connection box mounting.

Components of the room sensor

The illustration below shows the room sensor and its components.

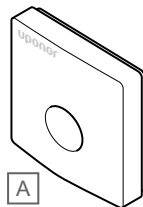

CD0000264

| Item | Description |
|------|------------------------|
| A | Smatrix Move PRO S-155 |

Uponor Smatrix Move PRO S-157

The sensor is designed to measure the relative humidity within the zone.

The sensor is only used in zones setup as **Stand Alone Control**.

Functions

Main characteristics:

- Sensor range is 0 – 100 %.
- Prepared for wall or connection box mounting.

Components of the humidity sensor

The illustration below shows the humidity sensor and its components.

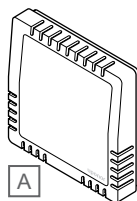

CD0000265

| Item | Description |
|------|------------------------|
| A | Smatrix Move PRO S-157 |

Uponor Smatrix Move PRO S-158

The snow sensor is designed to be embedded into outdoor surfaces to measure the ground temperature and moisture level.

The sensor is only used in zones setup as **Meltaway**. To ensure the snow melting function, two Uponor Smatrix Move PRO S-158 and three supply/return sensors must be installed.

Functions

Main characteristics:

- Detects moisture.
- Detects temperature.
- Horizontal installation to ensure collection of draining melt water.

Options:

- The sensor can be used as either ground temperature sensor or ground moisture sensor. It cannot be used for both at once.

Components of the snow sensor

The illustration below shows the snow sensor and its components.

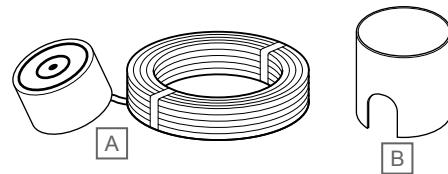

CD0000267

| Item | Description |
|------|------------------------|
| A | Smatrix Move PRO S-158 |
| B | Mounting socket |

Uponor Smatrix Move PRO S-159

The sensor set is designed to detect and prevent condensation while the zone is in cooling mode.

The sensor is only used in zones setup as **Stand Alone Control** or **Smatrix Base PRO**.

Functions

Main characteristics:

- Sensor range: Condensation detected, Yes/No.
- Converter for cooling allowed signal.

Components of the condensation sensor

The illustration below shows the condensation sensor and its components.

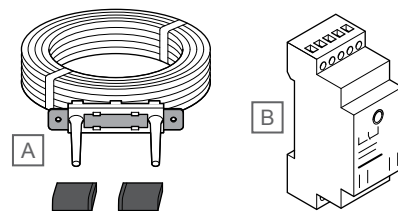

CD0000268

| Item | Description |
|------|---------------------|
| A | Condensation sensor |
| B | Converter |

7 Network connectivity

7.1 Uponor Smatrix Wave Pulse

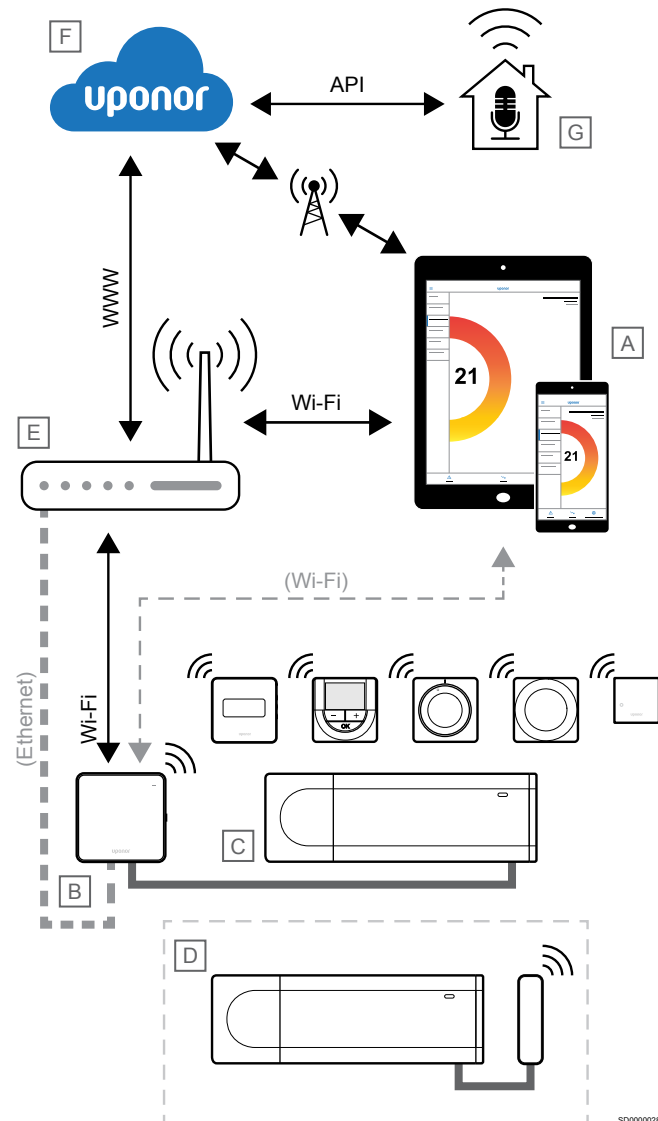

Note

Setting up a system with a communication module requires a mobile device (smart phone/tablet).

The room controller (C) can be setup and controlled using the Uponor Smatrix Pulse app (A) and communication module (B) through different connection methods.

Direct connection

The Uponor Smatrix Pulse app (A) communicates with the room controller (C) via direct connection to the communication module (B).

- The mobile device connects directly, using Wi-Fi, to the access point in the communication module (B).
- The sub room controller (D) communicates via the master room controller (C).

When is this method is used?

- When installing and setting up a system.
- During normal operation when there is no local Wi-Fi network available.

Local Wi-Fi connection

The Uponor Smatrix PULSE app (A) communicates with the room controller (C) via the communication module (B), connected to the local Wi-Fi network.

- The mobile device connects to the same Wi-Fi router (E) as the communication module (B).
- The communication module (B) and Wi-Fi router (E) are connected using either Wi-Fi or ethernet.
- The sub room controller (D) communicates via the master room controller (C).

When is this method is used?

- During normal operation when connected to the same local Wi-Fi network.

Remote connection

Note

Remote connection requires the user to setup a Uponor cloud services user account.

The Uponor Smatrix Pulse app (A) communicates with the room controller (C) via a remote connection to the communication module (B).

- The mobile device connects to Uponor cloud services (F) over internet (via local Wi-Fi or mobile network).
- Uponor cloud services (F) connect to the communication module (B) via the local internet connected Wi-Fi router (E).
- The communication module (B) and Wi-Fi router (E) are connected using either Wi-Fi or ethernet.
- The sub room controller (D) communicates via the master room controller (C).

When is this method is used?

- During normal operation when outside the local Wi-Fi network.

API connection

Note

API connection requires the user to setup a Uponor cloud services user account.

The external system (G) communicates with the room controller (C) via an Application Programming Interface (API). An external system can be a heat pump, a smart home system, or a voice control assistant etc.

- The external system (G) uses an API to communicate with Uponor cloud services (F).
- Uponor cloud services (F) connect to the communication module (B) via the local internet connected Wi-Fi router (E).
- The communication module (B) and Wi-Fi router (E) are connected using either Wi-Fi or ethernet.
- The sub room controller (D) communicates via the master room controller (C).

When is this method is used?

- When external systems, such as heat pumps, smart home systems, voice control assistants etc, communicate with the Uponor Smatrix Pulse system.

7.2 Uponor Smatrix Base Pulse

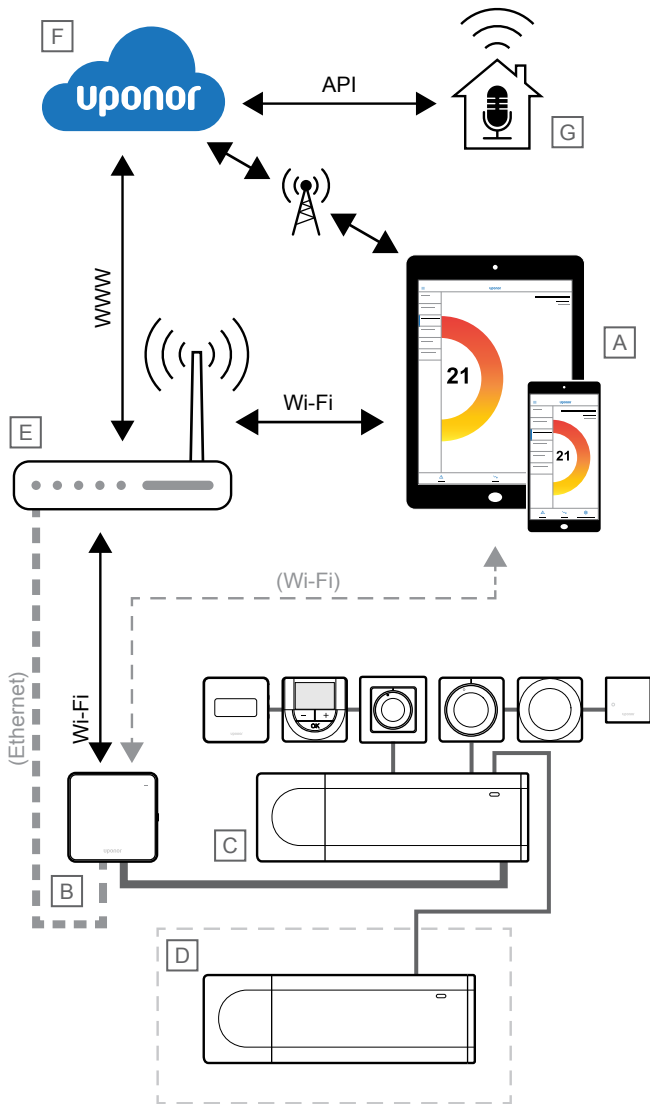

Note

Setting up a system with a communication module requires a mobile device (smart phone/tablet).

The room controller (C) can be setup and controlled using the Uponor Smatrix Pulse app (A) and communication module (B) through different connection methods.

Direct connection

The Uponor Smatrix Pulse app (A) communicates with the room controller (C) via direct connection to the communication module (B).

- The mobile device connects directly, using Wi-Fi, to the access point in the communication module (B).
- The sub room controller (D) communicates via the master room controller (C).

When is this method is used?

- When installing and setting up a system.
- During normal operation when there is no local Wi-Fi network available.

Local Wi-Fi connection

The Uponor Smatrix PULSE app (A) communicates with the room controller (C) via the communication module (B), connected to the local Wi-Fi network.

- The mobile device connects to the same Wi-Fi router (E) as the communication module (B).
- The communication module (B) and Wi-Fi router (E) are connected using either Wi-Fi or ethernet.
- The sub room controller (D) communicates via the master room controller (C).

When is this method is used?

- During normal operation when connected to the same local Wi-Fi network.

Remote connection

Note

Remote connection requires the user to setup a Uponor cloud services user account.

The Uponor Smatrix Pulse app (A) communicates with the room controller (C) via a remote connection to the communication module (B).

- The mobile device connects to Uponor cloud services (F) over internet (via local Wi-Fi or mobile network).
- Uponor cloud services (F) connect to the communication module (B) via the local internet connected Wi-Fi router (E).
- The communication module (B) and Wi-Fi router (E) are connected using either Wi-Fi or ethernet.
- The sub room controller (D) communicates via the master room controller (C).

When is this method is used?

- During normal operation when outside the local Wi-Fi network.

API connection

Note

API connection requires the user to setup a Uponor cloud services user account.

The external system (G) communicates with the room controller (C) via an Application Programming Interface (API). An external system can be a heat pump, a smart home system, or a voice control assistant etc.

- The external system (G) uses an API to communicate with Uponor cloud services (F).
- Uponor cloud services (F) connect to the communication module (B) via the local internet connected Wi-Fi router (E).
- The communication module (B) and Wi-Fi router (E) are connected using either Wi-Fi or ethernet.
- The sub room controller (D) communicates via the master room controller (C).

When is this method is used?

- When external systems, such as heat pumps, smart home systems, voice control assistants etc, communicate with the Uponor Smatrix Pulse system.

8 Application examples – Wave Pulse

8.1 Underfloor heating or underfloor heating/cooling with multiple sub room controllers

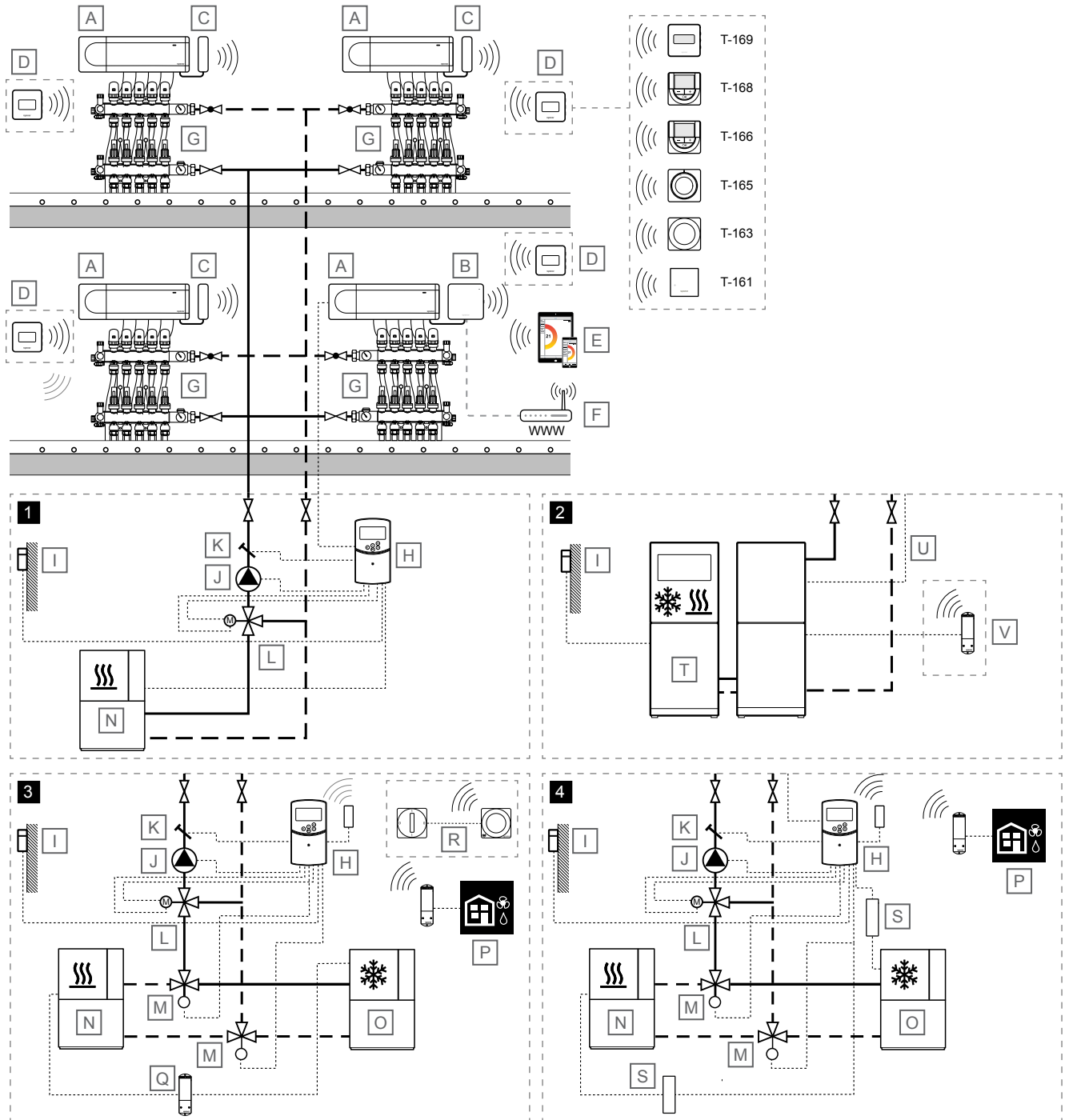

SD0000035

| | |
|-------------|---|
| ! | Note |
| | These are outline diagrams. Real systems must be installed according to applicable norms and regulations. |
| Item | Description |
| A | Uponor Smatrix Wave PULSE X-265 |

| | |
|-------------|-------------------------------------|
| Item | Description |
| | Room controller |
| B | Uponor Smatrix PULSE Com R-208 |
| | Communication module |
| | Connected to master room controller |

| Item | Description |
|------|--|
| C | Uponor Smatrix Wave PULSE A-265 Antenna |
| D | Room thermostat <ul style="list-style-type: none"> • Uponor Smatrix Wave T-161 Room sensor thermostat with relative humidity sensor and operative sensor • Uponor Smatrix Wave T-163 Public thermostat • Uponor Smatrix Wave T-165 Standard thermostat with print on dial • Uponor Smatrix Wave T-166 Digital thermostat • Uponor Smatrix Wave T-168 Programmable digital thermostat with relative humidity sensor • Uponor Smatrix Wave T-169 Digital thermostat with relative humidity sensor and operative sensor |
| E | Mobile device (smartphone, tablet, etc) |
| F | Wi-Fi router |
| G | Manifold with actuator |
| H | Uponor Smatrix Move X-157 Supply temperature controller, with optional antenna (required if using room thermostat) |
| I | Outdoor temperature sensor |
| J | Circulation pump |
| K | Supply temperature sensor |
| L | 3 way mixing valve with 230 V 3-point actuator |
| M | Heating/cooling switchover valve with 230 V actuator |
| N | Heat source |
| O | Chiller |
| P | <i>Optional</i> Dehumidifier activation from room controller (one dehumidifier per room controller) via Uponor Smatrix Wave M-161 (relay module) registered to the room controller |
| Q | <i>Optional</i> Heating/cooling activation from room controller via Uponor Smatrix Wave M-161 (relay module) |
| R | <i>Optional</i> External heating/cooling switch via Uponor Smatrix Wave T-163 (public thermostat registered as system device to master room controller) |
| S | Heating/cooling relay, 230 V |
| T | Heat pump (which optionally can produce heating/cooling) |
| U | Wire for heating/cooling switchover Connected between master room controller (relay 2, boiler, configured to heating/cooling output) and heatpump (contact sensing input, configured for heating/cooling switch) |
| V | <i>Optional</i> Uponor Smatrix Wave M-161 (relay module), registered to the room controller connected to a contact sensing input, configured for heating/cooling switch, in the heat pump |

Room temperature control

This application example shows underfloor heating, or underfloor heating/cooling, with multiple sub room controllers.

The room temperature (heating and/or cooling) is controlled by four Uponor Smatrix Wave Pulse room controllers and thermostats merged into one large system (one master room controller together with three sub room controllers). The room controllers regulate the

flow to each room by operating the actuators on the underfloor manifold.

The master room controller is selected by connecting the communication module to it. Only one communication module per system can be connected, and the sub room controllers use the antenna for communication with thermostats and the master room controller. See *Uponor Smatrix Wave Pulse*, Page 30 for more information about how to communicate with the communication module.

See *Cooling with high protection to avoid condensation*, Page 3 and *Cooling function*, Page 6 for more information about setting up the system for cooling in the Uponor Smatrix Pulse app.

Heating/cooling switchover is done either in the Uponor Smatrix Pulse app (H/C master), automatically depending on supply line temperature or indoor/outdoor temperature (H/C master), or by the GPI (H/C slave).

Supply temperature control

The application example shows four different ways of controlling the supply temperature.

1 - Heating with Uponor Smatrix Move supply controller

The supply temperature is regulated using a supply temperature controller (Uponor Smatrix Move) with outdoor temperature sensor and heating curve.

Connected to the supply temperature controller is the master room controller, heat pump, circulation pump, supply temperature sensor, and 3 way mixing valve.

The master room controller connects from the circulation pump relay (relay 1) to one of the supply temperature controller ROOMSTAT input (setup as **C_b**). When the relay in the room controller closes, the supply temperature controller starts the circulation pump.

2 - Heating/cooling with heat pump



Note

This supply temperature control option requires a heat pump which can produce both heating and cooling.

The supply temperature (for both heating and cooling, if the heat pump can produce both) is regulated using a heat pump.

The master room controller connects from the circulation pump relay (relay 1) to the heat pump (to a relay for heat demand). When the relay in the room controller closes, the heat pump starts the circulation pump.

The master room controller also connects from the boiler relay (relay 2, setup as heating/cooling switch) to the heat pump (to a relay for heating/cooling switch). When the relay in the room controller closes, the heat pump switches to cooling.

Optionally, the heatpump can switch between heating and cooling using a wireless relay module, registered to the master room controller.

3 - Heating/cooling (switched from room controller) with Uponor Smatrix Move supply temperature controller

The supply temperature is regulated using a supply temperature controller (Uponor Smatrix Move) with outdoor temperature sensor and heating/cooling curves.

Connected to the supply temperature controller is the circulation pump, supply temperature sensor, 3 way mixing valve, and heating/cooling switchover valve. The heat source and chiller is controlled by a relay module registered to the master room controller.

With a registered wireless thermostat (requires antenna A-155), the Uponor Smatrix Move controller is be integrated with an Uponor Smatrix Wave Pulse system to enhance the capabilities of a full climate system. At the same time, the integration removes the need of a separate thermostat, and outdoor sensor (if connected to the Wave Pulse system), for the Move system.

Information regarding system state and reference room temperature is forwarded to the supply temperature controller, which adjusts the supply temperature accordingly.

Different system states and temperatures which can be forwarded are:

- Comfort/ECO mode*
- Heating/cooling mode
- Holiday mode*
- Reference room temperature and setpoint
- Outdoor temperature (if installed in the thermostat)
- Remote sensor (if installed in the thermostat)
- Indication if the relative humidity exceeds set limits (requires the digital thermostat T-168 or T-169, and communication module)

*) Through change of setpoint, using the ECO setback value from the integrated system. No indication or change of mode is shown in the Move controller.

Optionally, one dehumidifier (via relay module Uponor Smatrix Wave M-161) per room controller can be connected, and an external heating/cooling switch via Uponor Smatrix Wave T-163 (public thermostat as system device) can be registered to the master room controller. Do not use a dehumidifier together with fancoils.

4 - Heating/cooling with Uponor Smatrix Move supply temperature controller

The supply temperature is regulated using a supply temperature controller (Uponor Smatrix Move) with outdoor temperature sensor and heating/cooling curves.

Connected to the supply temperature controller is the heat source (via heating/cooling relay), chiller (via heating/cooling relay), circulation pump, supply temperature sensor, 3 way mixing valve, and heating/cooling switchover valve.

With a registered wireless thermostat (requires antenna A-155), the Uponor Smatrix Move controller is be integrated with an Uponor Smatrix Wave Pulse system to enhance the capabilities of a full climate system. At the same time, the integration removes the need of a separate thermostat, and outdoor sensor (if connected to the Wave Pulse system), for the Move system.

Information regarding system state and reference room temperature is forwarded to the supply temperature controller, which adjusts the supply temperature accordingly.

Different system states and temperatures which can be forwarded are:

- Comfort/ECO mode*
- Heating/cooling mode
- Holiday mode*
- Reference room temperature and setpoint
- Outdoor temperature (if installed in the thermostat)
- Remote sensor (if installed in the thermostat)
- Indication if the relative humidity exceeds set limits (requires the digital thermostat T-168 or T-169, and communication module)

*) Through change of setpoint, using the ECO setback value from the integrated system. No indication or change of mode is shown in the Move controller.

Optionally, one dehumidifier (via relay module Uponor Smatrix Wave M-161) per room controller can be connected. Do not use a dehumidifier together with fancoils.

8.2 Underfloor heating or underfloor heating/cooling with a single room controller

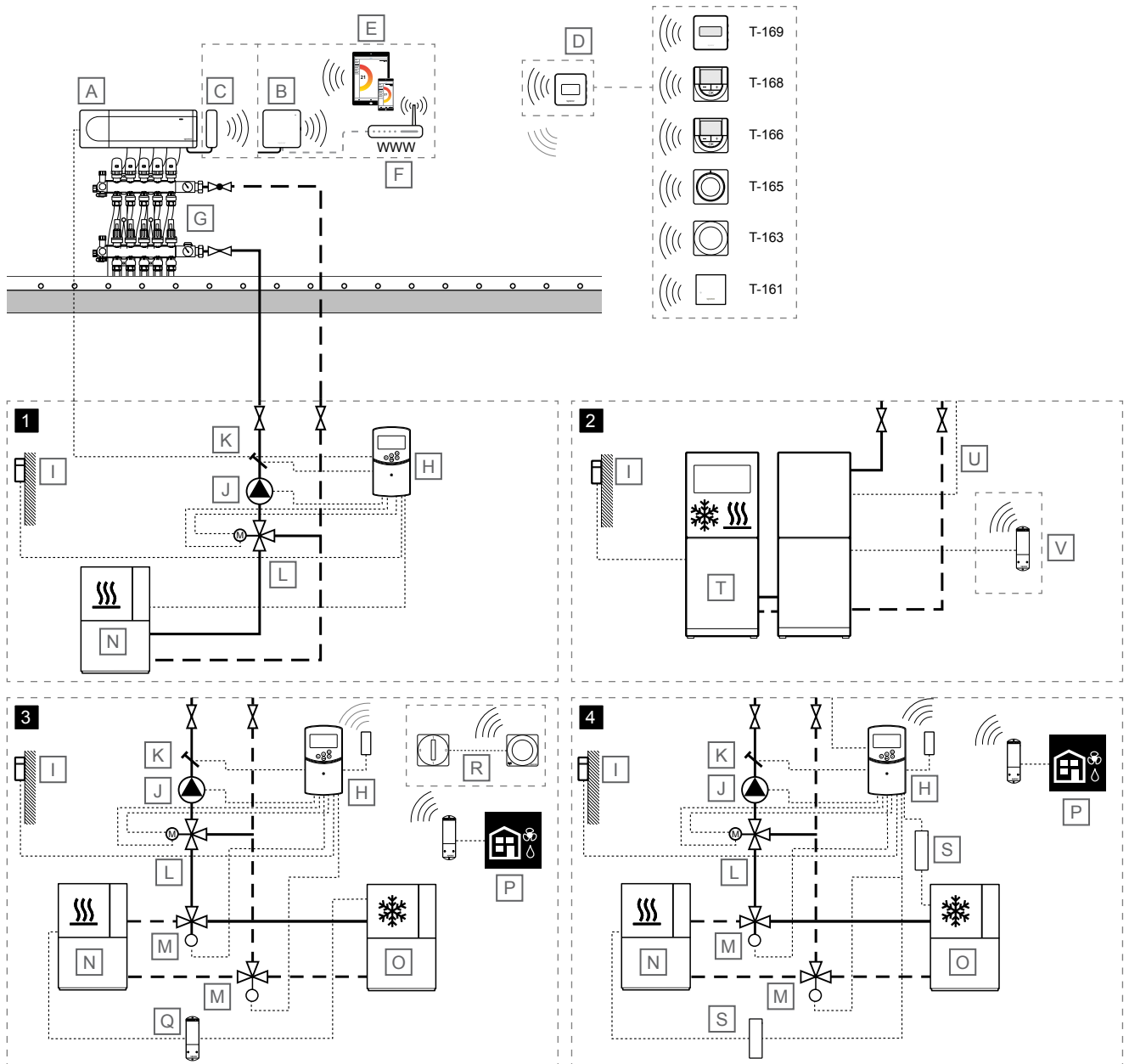

SD0000036

Note

These are outline diagrams. Real systems must be installed according to applicable norms and regulations.



| Item | Description |
|------|---|
| A | Uponor Smatrix Wave PULSE X-265 Room controller |
| B | Uponor Smatrix PULSE Com R-208 Communication module Connected to master room controller |
| C | Uponor Smatrix Wave PULSE A-265 Antenna |
| D | Room thermostat |

Item Description

- Uponor Smatrix Wave T-161
Room sensor thermostat with relative humidity sensor and operative sensor
- Uponor Smatrix Wave T-163
Public thermostat
- Uponor Smatrix Wave T-165
Standard thermostat with print on dial
- Uponor Smatrix Wave T-166
Digital thermostat
- Uponor Smatrix Wave T-168
Programmable digital thermostat with relative humidity sensor
- Uponor Smatrix Wave T-169

| Item | Description |
|------|---|
| | Digital thermostat with relative humidity sensor and operative sensor |
| E | Mobile device (smartphone, tablet, etc) |
| F | Wi-Fi router |
| G | Manifold with actuator |
| H | Uponor Smatrix Move X-157 Supply temperature controller, with optional antenna (required if using room thermostat) |
| I | Outdoor temperature sensor |
| J | Circulation pump |
| K | Supply temperature sensor |
| L | 3 way mixing valve with 230 V 3-point actuator |
| M | Heating/cooling switchover valve with 230 V actuator |
| N | Heat source |
| O | Chiller |
| P | <i>Optional</i> Dehumidifier activation from room controller (one dehumidifier per room controller) via Uponor Smatrix Wave M-161 (relay module) registered to the room controller |
| Q | <i>Optional</i> Heating/cooling activation from room controller via Uponor Smatrix Wave M-161 (relay module) |
| R | <i>Optional</i> External heating/cooling switch via Uponor Smatrix Wave T-163 (public thermostat registered as system device to master room controller) |
| S | Heating/cooling relay, 230 V |
| T | Heat pump (which optionally can produce heating/cooling) |
| U | Wire for heating/cooling switchover Connected between master room controller (relay 2, boiler, configured to heating/cooling output) and heatpump (contact sensing input, configured for heating/cooling switch) |
| V | <i>Optional</i> Uponor Smatrix Wave M-161 (relay module), registered to the room controller connected to a contact sensing input, configured for heating/cooling switch, in the heat pump |

Room temperature control

| | |
|---|---|
|  | Caution! The communication module is required for use with Supply temperature control 2 - 4 . |
|  | Note The system can be operated without a communication module, with only an antenna attached to the room controller. But this will reduce the functionality of the system. |

This application example shows underfloor heating, or underfloor heating/cooling, with a single room controller.

The room temperature (heating and/or cooling) is controlled by a single Uponor Smatrix Wave Pulse room controller and thermostats. The room controller regulate the flow to each room by operating the actuators on the underfloor manifold.

See *Cooling with high protection to avoid condensation, Page 3* and *Cooling function, Page 6* for more information about setting up the system for cooling in the Uponor Smatrix Pulse app.

Heating/cooling switchover is done either in the Uponor Smatrix Pulse app (H/C master), automatically depending on supply line temperature or indoor/outdoor temperature (H/C master), or by the GPI (H/C slave).

Supply temperature control

The application example shows four different ways of controlling the supply temperature.

1 - Heating with Uponor Smatrix Move supply controller

The supply temperature is regulated using a supply temperature controller (Uponor Smatrix Move) with outdoor temperature sensor and heating curve.

Connected to the supply temperature controller is the master room controller, heat pump, circulation pump, supply temperature sensor, and 3 way mixing valve.

The master room controller connects from the circulation pump relay (relay 1) to one of the supply temperature controller ROOMSTAT input (setup as **C_b**). When the relay in the room controller closes, the supply temperature controller starts the circulation pump.

2 - Heating/cooling with heat pump

| | |
|---|--|
|  | Note This supply temperature control option requires a heat pump which can produce both heating and cooling. |
|---|--|

The supply temperature (for both heating and cooling, if the heat pump can produce both) is regulated using a heat pump.

The master room controller connects from the circulation pump relay (relay 1) to the heat pump (to a relay for heat demand). When the relay in the room controller closes, the heat pump starts the circulation pump.

The master room controller also connects from the boiler relay (relay 2, setup as heating/cooling switch) to the heat pump (to a relay for heating/cooling switch). When the relay in the room controller closes, the heat pump switches to cooling.

Optionally, the heatpump can switch between heating and cooling using a wireless relay module, registered to the master room controller.

3 - Heating/cooling (switched from room controller) with Uponor Smatrix Move supply temperature controller

The supply temperature is regulated using a supply temperature controller (Uponor Smatrix Move) with outdoor temperature sensor and heating/cooling curves.

Connected to the supply temperature controller is the circulation pump, supply temperature sensor, 3 way mixing valve, and heating/cooling switchover valve. The heat source and chiller is controlled by a relay module registered to the master room controller.

With a registered wireless thermostat (requires antenna A-155), the Uponor Smatrix Move controller is be integrated with an Uponor Smatrix Wave Pulse system to enhance the capabilities of a full climate system. At the same time, the integration removes the need of a separate thermostat, and outdoor sensor (if connected to the Wave Pulse system), for the Move system.

Information regarding system state and reference room temperature is forwarded to the supply temperature controller, which adjusts the supply temperature accordingly.

Different system states and temperatures which can be forwarded are:

- Comfort/ECO mode*
- Heating/cooling mode
- Holiday mode*
- Reference room temperature and setpoint
- Outdoor temperature (if installed in the thermostat)

- Remote sensor (if installed in the thermostat)
- Indication if the relative humidity exceeds set limits (requires the digital thermostat T-168 or T-169, and communication module)

*) Through change of setpoint, using the ECO setback value from the integrated system. No indication or change of mode is shown in the Move controller.

Optionally, one dehumidifier (via relay module Uponor Smatrix Wave M-161) per room controller can be connected, and an external heating/cooling switch via Uponor Smatrix Wave T-163 (public thermostat as system device) can be registered to the master room controller. Do not use a dehumidifier together with fancoils.

4 - Heating/cooling with Uponor Smatrix Move supply temperature controller

The supply temperature is regulated using a supply temperature controller (Uponor Smatrix Move) with outdoor temperature sensor and heating/cooling curves.

Connected to the supply temperature controller is the heat source (via heating/cooling relay), chiller (via heating/cooling relay), circulation pump, supply temperature sensor, 3 way mixing valve, and heating/cooling switchover valve.

With a registered wireless thermostat (requires antenna A-155), the Uponor Smatrix Move controller is be integrated with an Uponor Smatrix Wave Pulse system to enhance the capabilities of a full

climate system. At the same time, the integration removes the need of a separate thermostat, and outdoor sensor (if connected to the Wave Pulse system), for the Move system.

Information regarding system state and reference room temperature is forwarded to the supply temperature controller, which adjusts the supply temperature accordingly.

Different system states and temperatures which can be forwarded are:

- Comfort/ECO mode*
- Heating/cooling mode
- Holiday mode*
- Reference room temperature and setpoint
- Outdoor temperature (if installed in the thermostat)
- Remote sensor (if installed in the thermostat)
- Indication if the relative humidity exceeds set limits (requires the digital thermostat T-168 or T-169, and communication module)

*) Through change of setpoint, using the ECO setback value from the integrated system. No indication or change of mode is shown in the Move controller.

Optionally, one dehumidifier (via relay module Uponor Smatrix Wave M-161) per room controller can be connected. Do not use a dehumidifier together with fancoils.

8.3 Underfloor heating/cooling with two stand alone room controllers

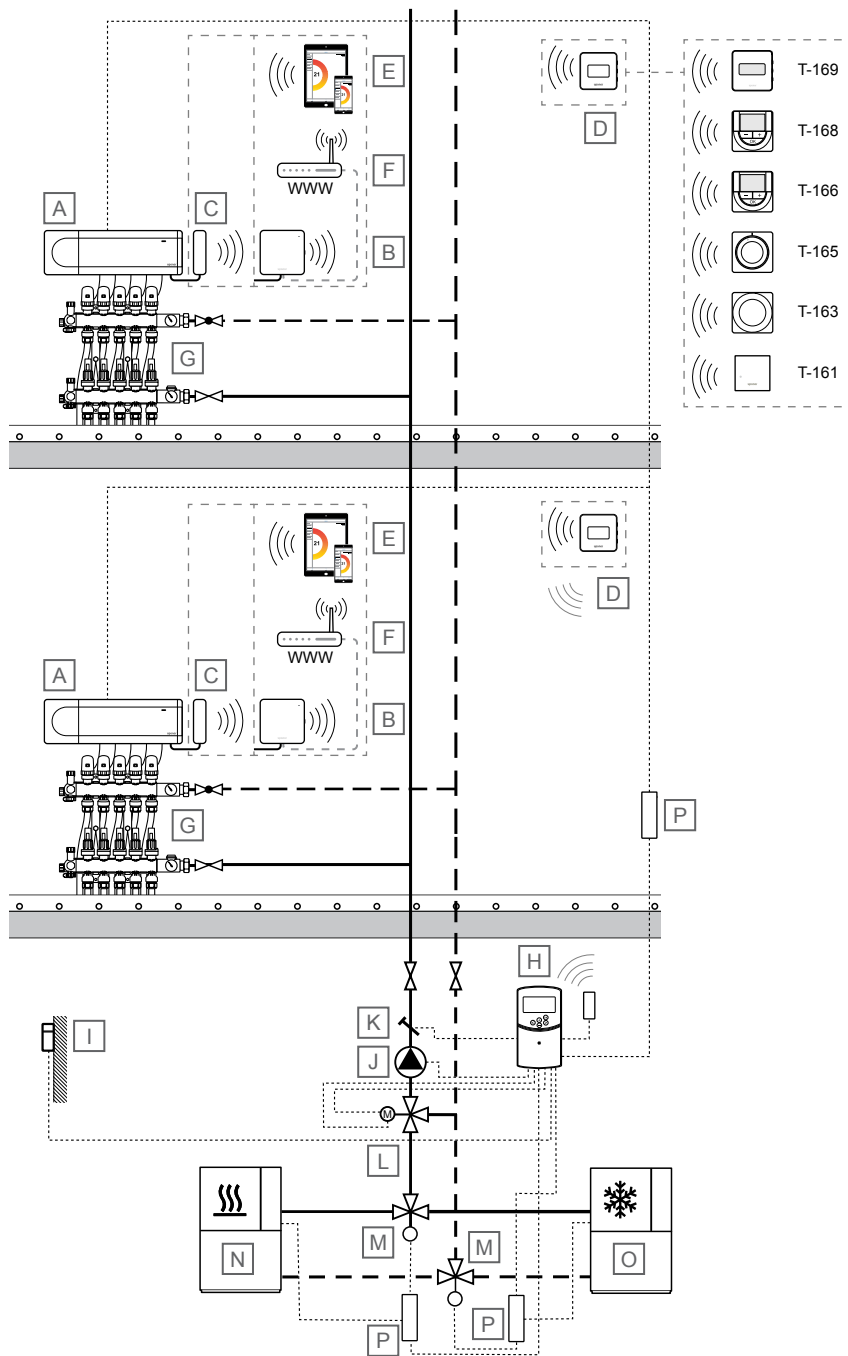

SD0000037

Note

These are outline diagrams. Real systems must be installed according to applicable norms and regulations.

| Item | Description |
|------|---|
| A | Uponor Smatrix Wave PULSE X-265 Room controller |
| B | Uponor Smatrix PULSE Com R-208 Communication module Connected to master room controller |
| C | Uponor Smatrix Wave PULSE A-265 Antenna |

Item Description

| | |
|---|---|
| D | Room thermostat <ul style="list-style-type: none"> • Uponor Smatrix Wave T-161 Room sensor thermostat with relative humidity sensor and operative sensor • Uponor Smatrix Wave T-163 Public thermostat • Uponor Smatrix Wave T-165 Standard thermostat with print on dial • Uponor Smatrix Wave T-166 Digital thermostat • Uponor Smatrix Wave T-168 |
|---|---|

| Item | Description |
|------|---|
| | Programmable digital thermostat with relative humidity sensor |
| | <ul style="list-style-type: none"> Uponor Smatrix Wave T-169 Digital thermostat with relative humidity sensor and operative sensor |
| E | Mobile device (smartphone, tablet, etc) |
| F | Wi-Fi router |
| G | Manifold with actuator |
| H | Uponor Smatrix Move X-157 |
| | Supply temperature controller, with optional antenna (required if using room thermostat) |
| I | Outdoor temperature sensor |
| J | Circulation pump |
| K | Supply temperature sensor |
| L | 3 way mixing valve with 230 V 3-point actuator |
| M | Heating/cooling switchover valve with 230 V actuator |
| N | Heat source |
| O | Chiller |
| P | Heating/cooling relay, 230 V |

Room temperature control

| Note | |
|------|--|
| ! | The system can be operated without a communication module, with only an antenna attached to the room controller. But this will reduce the functionality of the system. |

This application example shows underfloor heating/cooling with two stand alone room controllers.

The room temperature (heating and/or cooling) in each system is controlled by a single Uponor Smatrix Wave Pulse room controller and thermostats. The room controller regulate the flow to each room by operating the actuators on the underfloor manifold. Both systems use the same supply line.

See *Cooling with high protection to avoid condensation, Page 3* and *Cooling function, Page 6* for more information about setting up the system for cooling in the Uponor Smatrix Pulse app.

Heating/cooling switchover is done either in the Uponor Smatrix Pulse app (H/C master), automatically depending on supply line temperature or indoor/outdoor temperature (H/C master), or by the GPI (H/C slave).

Supply temperature control

The supply temperature is regulated using a supply temperature controller (Uponor Smatrix Move) with outdoor temperature sensor and heating/cooling curves.

Connected to the supply temperature controller is the heat source (via heating/cooling relay), chiller (via heating/cooling relay), circulation pump, supply temperature sensor, 3 way mixing valve, and heating/cooling switchover valve.

With a registered wireless thermostat (requires antenna A-155), the Uponor Smatrix Move controller is be integrated with an Uponor Smatrix Wave Pulse system to enhance the capabilities of a full climate system. At the same time, the integration removes the need of a separate thermostat, and outdoor sensor (if connected to the Wave Pulse system), for the Move system.

Information regarding system state and reference room temperature is forwarded to the supply temperature controller, which adjusts the supply temperature accordingly.

Different system states and temperatures which can be forwarded are:

- Comfort/ECO mode*
- Heating/cooling mode
- Holiday mode*
- Reference room temperature and setpoint
- Outdoor temperature (if installed in the thermostat)
- Remote sensor (if installed in the thermostat)
- Indication if the relative humidity exceeds set limits (requires the digital thermostat T-168 or T-169, and communication module)

*) Through change of setpoint, using the ECO setback value from the integrated system. No indication or change of mode is shown in the Move controller.

Optionally, one dehumidifier (via relay module Uponor Smatrix Wave M-161) per room controller can be connected. Do not use a dehumidifier together with fancoils.

8.4 Underfloor heating and radiators with multiple sub room controllers

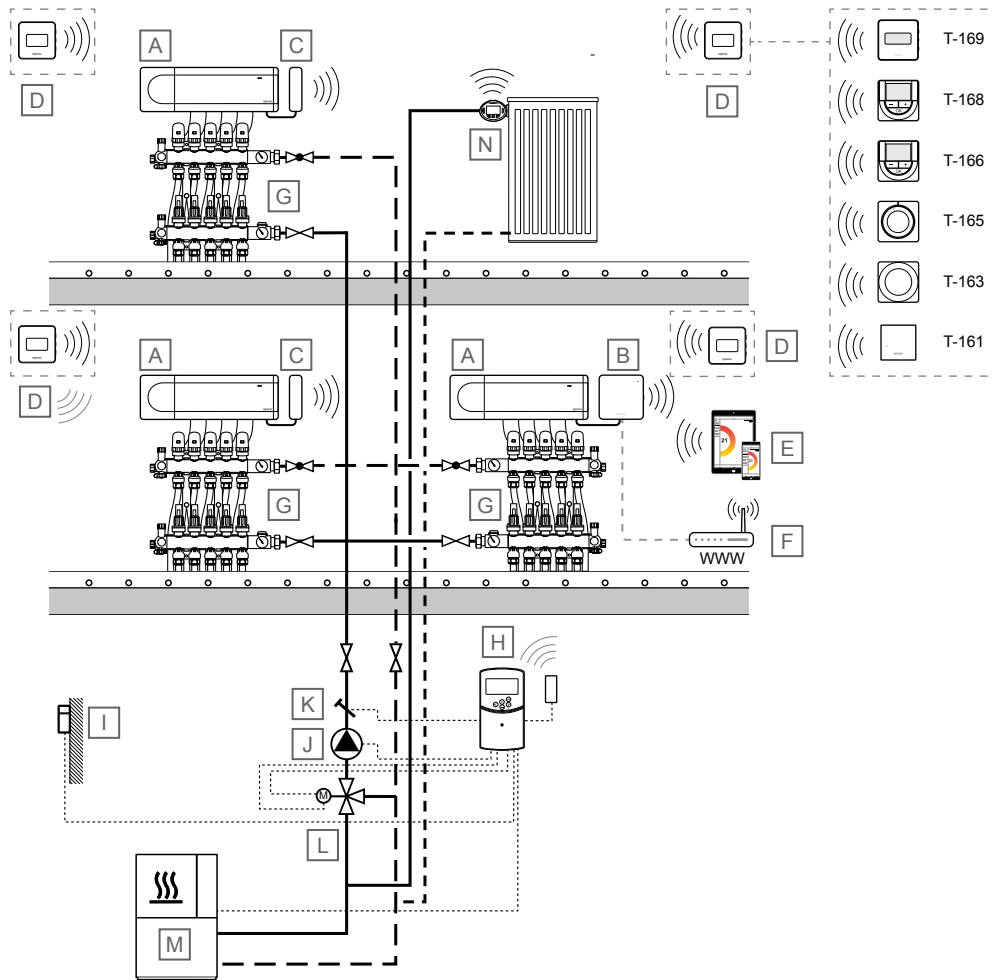

SD000038

Note

These are outline diagrams. Real systems must be installed according to applicable norms and regulations.

| Item | Description |
|------|---|
| A | Uponor Smatrix Wave PULSE X-265 Room controller |
| B | Uponor Smatrix PULSE Com R-208 Communication module Connected to master room controller |
| C | Uponor Smatrix Wave PULSE A-265 Antenna |
| D | Room thermostat <ul style="list-style-type: none"> • Uponor Smatrix Wave T-161 Room sensor thermostat with relative humidity sensor and operative sensor • Uponor Smatrix Wave T-163 Public thermostat • Uponor Smatrix Wave T-165 Standard thermostat with print on dial • Uponor Smatrix Wave T-166 Digital thermostat • Uponor Smatrix Wave T-168 Programmable digital thermostat with relative humidity sensor |

| Item | Description |
|------|---|
| | <ul style="list-style-type: none"> • Uponor Smatrix Wave T-169 Digital thermostat with relative humidity sensor and operative sensor |
| E | Mobile device (smartphone, tablet, etc) |
| F | Wi-Fi router |
| G | Manifold with actuator |
| H | Uponor Smatrix Move X-157 Supply temperature controller, with optional antenna (required if using room thermostat) |
| I | Outdoor temperature sensor |
| J | Circulation pump |
| K | Supply temperature sensor |
| L | 3 way mixing valve with 230 V 3-point actuator |
| M | Heat source |
| N | Uponor Smatrix Wave T-162 Thermostatic head |

Room temperature control

This application example shows underfloor heating and radiators with multiple sub room controllers.

The room temperature is controlled by three Uponor Smatrix Wave Pulse room controllers and thermostats merged into one large system (one master room controller together with two sub room

controllers). The room controllers regulate the flow to each room by operating the actuators on the underfloor manifold, and by operating the thermostatic heads (installed on the radiator valves).

The master room controller is selected by connecting the communication module to it. Only one communication module per system can be connected, and the sub room controllers use the antenna for communication with thermostats and the master room controller. See *Uponor Smatrix Wave Pulse, Page 30* for more information about how to communicate with the communication module.

Supply temperature control

The supply temperature is regulated using a supply temperature controller (Uponor Smatrix Move) with outdoor temperature sensor and heating curve.

Connected to the supply temperature controller is the master room controller, heat pump, circulation pump, supply temperature sensor, and 3 way mixing valve.

With a registered wireless thermostat (requires antenna A-155), the Uponor Smatrix Move controller is be integrated with an Uponor

Smatrix Wave Pulse system to enhance the capabilities of a full climate system. At the same time, the integration removes the need of a separate thermostat, and outdoor sensor (if connected to the Wave Pulse system), for the Move system.

Information regarding system state and reference room temperature is forwarded to the supply temperature controller, which adjusts the supply temperature accordingly.

Different system states and temperatures which can be forwarded are:

- Comfort/ECO mode*
- Heating/cooling mode
- Holiday mode*
- Reference room temperature and setpoint
- Outdoor temperature (if installed in the thermostat)
- Remote sensor (if installed in the thermostat)
- Indication if the relative humidity exceeds set limits (requires the digital thermostat T-168 or T-169, and communication module)

*) Through change of setpoint, using the ECO setback value from the integrated system. No indication or change of mode is shown in the Move controller.

8.5 Underfloor heating or underfloor heating/cooling, and electrical underfloor heating with a single room controller

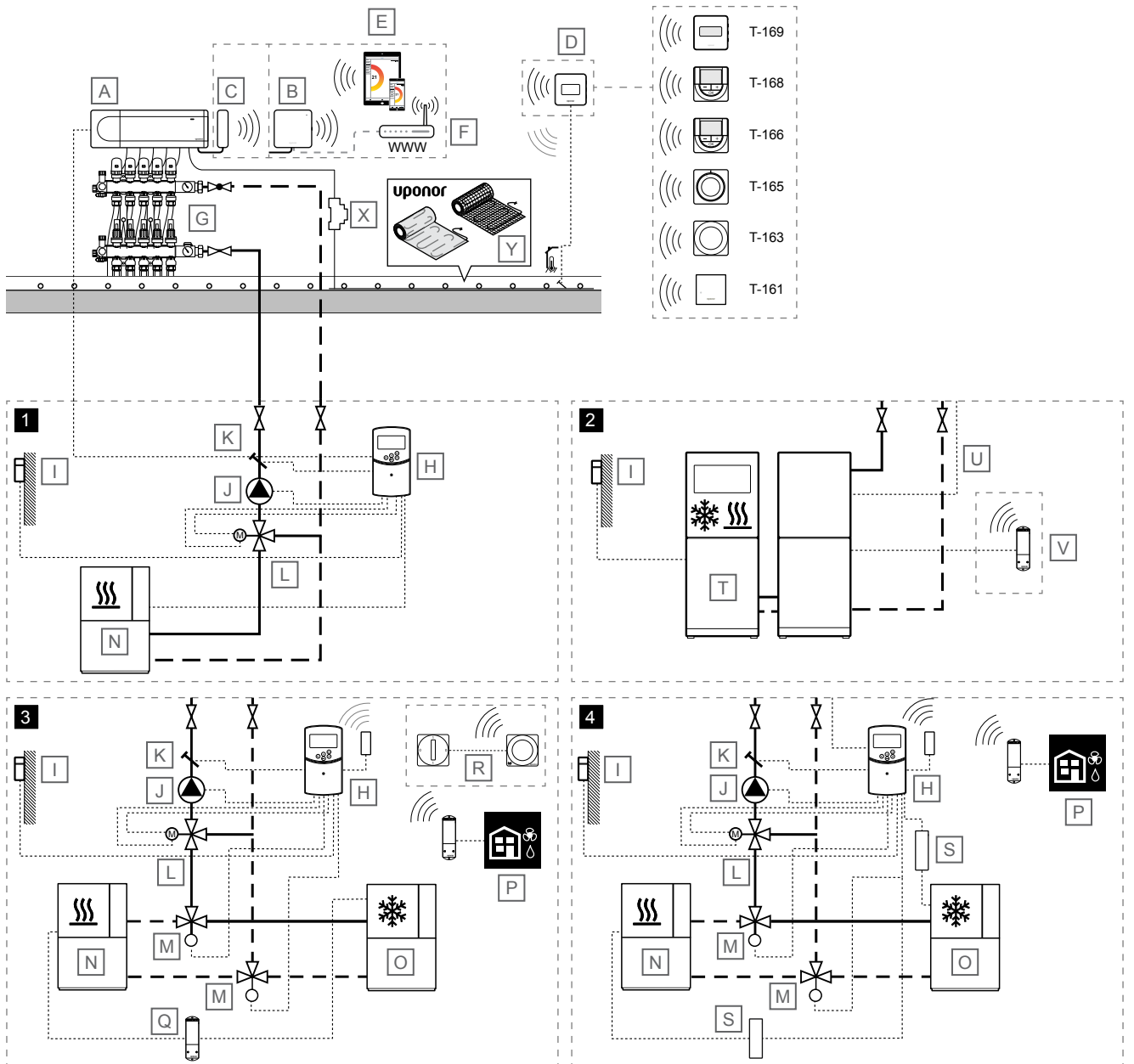

S0000039

| Item | Description |
|---|---|
| <p>Note</p> <p>These are outline diagrams. Real systems must be installed according to applicable norms and regulations.</p> | |
| A | Uponor Smatrix Wave PULSE X-265 Room controller |
| B | Uponor Smatrix PULSE Com R-208 Communication module Connected to master room controller |
| C | Uponor Smatrix Wave PULSE A-265 Antenna |
| D | Room thermostat |

| Item | Description |
|------|--|
| | <ul style="list-style-type: none"> Uponor Smatrix Wave T-161 Room sensor thermostat with relative humidity sensor and operative sensor Uponor Smatrix Wave T-163 Public thermostat Uponor Smatrix Wave T-165 Standard thermostat with print on dial Uponor Smatrix Wave T-166 Digital thermostat Uponor Smatrix Wave T-168 Programmable digital thermostat with relative humidity sensor Uponor Smatrix Wave T-169 |

| Item | Description |
|------|---|
| | Digital thermostat with relative humidity sensor and operative sensor |
| E | Mobile device (smartphone, tablet, etc) |
| F | Wi-Fi router |
| G | Manifold with actuator |
| H | Uponor Smatrix Move X-157 Supply temperature controller, with optional antenna (required if using room thermostat) |
| I | Outdoor temperature sensor |
| J | Circulation pump |
| K | Supply temperature sensor |
| L | 3 way mixing valve with 230 V 3-point actuator |
| M | Heating/cooling switchover valve with 230 V actuator |
| N | Heat source |
| O | Chiller |
| P | <i>Optional</i> Dehumidifier activation from room controller (one dehumidifier per room controller) via Uponor Smatrix Wave M-161 (relay module) registered to the room controller |
| Q | <i>Optional</i> Heating/cooling activation from room controller via Uponor Smatrix Wave M-161 (relay module) |
| R | <i>Optional</i> External heating/cooling switch via Uponor Smatrix Wave T-163 (public thermostat registered as system device to master room controller) |
| S | Heating/cooling relay, 230 V |
| T | Heat pump (which optionally can produce heating/cooling) |
| U | Wire for heating/cooling switchover Connected between master room controller (relay 2, boiler, configured to heating/cooling output) and heatpump (contact sensing input, configured for heating/cooling switch) |
| V | <i>Optional</i> Uponor Smatrix Wave M-161 (relay module), registered to the room controller connected to a contact sensing input, configured for heating/cooling switch, in the heat pump |
| X | 24 V AC relay (dimensioned for the correct load) |
| Y | Uponor electrical heating cable mat |

Room temperature control



Caution!
The communication module is required for this solution, because the room with electrical underfloor heating must be set to "Cooling not allowed" in the Uponor Smatrix Pulse app.

This application example shows underfloor heating or underfloor heating/cooling, and electrical underfloor heating with a single room controller.

The room temperature (heating and/or cooling) is controlled by a single Uponor Smatrix Wave Pulse room controller and thermostats. The room controller regulate the flow to each room by operating the actuators on the underfloor manifold. It also operate the electrical underfloor heating mats (connected to the room controller acuator connections, via a 24 V AC relay dimensioned for the correct load).

See *Cooling with high protection to avoid condensation, Page 3* and *Cooling function, Page 6* for more information about setting up the system for cooling in the Uponor Smatrix Pulse app.

Heating/cooling switchover is done either in the Uponor Smatrix Pulse app (H/C master), automatically depending on supply line temperature or indoor/outdoor temperature (H/C master), or by the GPI (H/C slave).

Supply temperature control

The application example shows four different ways of controlling the supply temperature.

1 - Heating with Uponor Smatrix Move supply controller

The supply temperature is regulated using a supply temperature controller (Uponor Smatrix Move) with outdoor temperature sensor and heating curve.

Connected to the supply temperature controller is the master room controller, heat pump, circulation pump, supply temperature sensor, and 3 way mixing valve.

The master room controller connects from the circulation pump relay (relay 1) to one of the supply temperature controller ROOMSTAT input (setup as **C_b**). When the relay in the room controller closes, the supply temperature controller starts the circulation pump.

2 - Heating/cooling with heat pump



Note
This supply temperature control option requires a heat pump which can produce both heating and cooling.

The supply temperature (for both heating and cooling, if the heat pump can produce both) is regulated using a heat pump.

The master room controller connects from the circulation pump relay (relay 1) to the heat pump (to a relay for heat demand). When the relay in the room controller closes, the heat pump starts the circulation pump.

The master room controller also connects from the boiler relay (relay 2, setup as heating/cooling switch) to the heat pump (to a relay for heating/cooling switch). When the relay in the room controller closes, the heat pump switches to cooling.

Optionally, the heatpump can switch between heating and cooling using a wireless relay module, registered to the master room controller.

3 - Heating/cooling (switched from room controller) with Uponor Smatrix Move supply temperature controller

The supply temperature is regulated using a supply temperature controller (Uponor Smatrix Move) with outdoor temperature sensor and heating/cooling curves.

Connected to the supply temperature controller is the circulation pump, supply temperature sensor, 3 way mixing valve, and heating/cooling switchover valve. The heat source and chiller is controlled by a relay module registered to the master room controller.

With a registered wireless thermostat (requires antenna A-155), the Uponor Smatrix Move controller is be integrated with an Uponor Smatrix Wave Pulse system to enhance the capabilities of a full climate system. At the same time, the integration removes the need of a separate thermostat, and outdoor sensor (if connected to the Wave Pulse system), for the Move system.

Information regarding system state and reference room temperature is forwarded to the supply temperature controller, which adjusts the supply temperature accordingly.

Different system states and temperatures which can be forwarded are:

- Comfort/ECO mode*
- Heating/cooling mode
- Holiday mode*
- Reference room temperature and setpoint
- Outdoor temperature (if installed in the thermostat)

- Remote sensor (if installed in the thermostat)
- Indication if the relative humidity exceeds set limits (requires the digital thermostat T-168 or T-169, and communication module)

*) Through change of setpoint, using the ECO setback value from the integrated system. No indication or change of mode is shown in the Move controller.

Optionally, one dehumidifier (via relay module Uponor Smatrix Wave M-161) per room controller can be connected, and an external heating/cooling switch via Uponor Smatrix Wave T-163 (public thermostat as system device) can be registered to the master room controller. Do not use a dehumidifier together with fancoils.

4 - Heating/cooling with Uponor Smatrix Move supply temperature controller

The supply temperature is regulated using a supply temperature controller (Uponor Smatrix Move) with outdoor temperature sensor and heating/cooling curves.

Connected to the supply temperature controller is the heat source (via heating/cooling relay), chiller (via heating/cooling relay), circulation pump, supply temperature sensor, 3 way mixing valve, and heating/cooling switchover valve.

With a registered wireless thermostat (requires antenna A-155), the Uponor Smatrix Move controller is be integrated with an Uponor Smatrix Wave Pulse system to enhance the capabilities of a full

climate system. At the same time, the integration removes the need of a separate thermostat, and outdoor sensor (if connected to the Wave Pulse system), for the Move system.

Information regarding system state and reference room temperature is forwarded to the supply temperature controller, which adjusts the supply temperature accordingly.

Different system states and temperatures which can be forwarded are:

- Comfort/ECO mode*
- Heating/cooling mode
- Holiday mode*
- Reference room temperature and setpoint
- Outdoor temperature (if installed in the thermostat)
- Remote sensor (if installed in the thermostat)
- Indication if the relative humidity exceeds set limits (requires the digital thermostat T-168 or T-169, and communication module)

*) Through change of setpoint, using the ECO setback value from the integrated system. No indication or change of mode is shown in the Move controller.

Optionally, one dehumidifier (via relay module Uponor Smatrix Wave M-161) per room controller can be connected. Do not use a dehumidifier together with fancoils.

8.6 Underfloor heating or underfloor heating/cooling, and fancoils with a single room controller

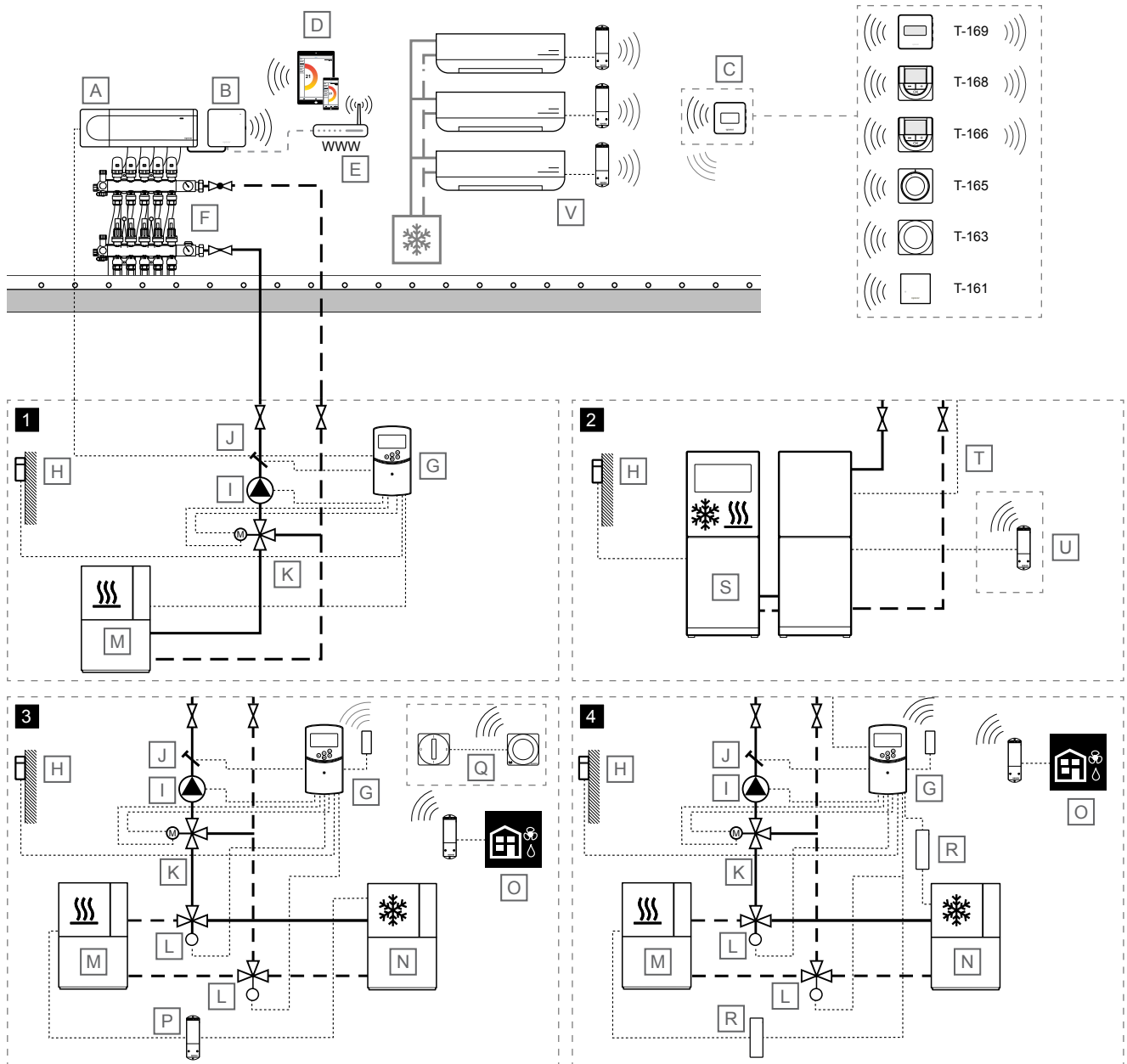

SD000040

Note

These are outline diagrams. Real systems must be installed according to applicable norms and regulations.

| Item | Description |
|------|---|
| A | Uponor Smatrix Wave PULSE X-265 Room controller |
| B | Uponor Smatrix PULSE Com R-208 Communication module Connected to master room controller |
| C | Room thermostat <ul style="list-style-type: none"> • Uponor Smatrix Wave T-161 |

| Item | Description |
|------|---|
| | Room sensor thermostat with relative humidity sensor and operative sensor <ul style="list-style-type: none"> • Uponor Smatrix Wave T-163 |
| | Public thermostat <ul style="list-style-type: none"> • Uponor Smatrix Wave T-165 |
| | Standard thermostat with print on dial <ul style="list-style-type: none"> • Uponor Smatrix Wave T-166 |
| | Digital thermostat <ul style="list-style-type: none"> • Uponor Smatrix Wave T-168 |
| | Programmable digital thermostat with relative humidity sensor <ul style="list-style-type: none"> • Uponor Smatrix Wave T-169 |
| | Digital thermostat with relative humidity sensor and operative sensor <ul style="list-style-type: none"> • Uponor Smatrix Wave T-161 |

| Item | Description |
|------|---|
| D | Mobile device (smartphone, tablet, etc) |
| E | Wi-Fi router |
| F | Manifold with actuator |
| G | Uponor Smatrix Move X-157 Supply temperature controller, with optional antenna (required if using room thermostat) |
| H | Outdoor temperature sensor |
| I | Circulation pump |
| J | Supply temperature sensor |
| K | 3 way mixing valve with 230 V 3-point actuator |
| L | Heating/cooling switchover valve with 230 V actuator |
| M | Heat source |
| N | Chiller |
| O | <i>Optional</i> Dehumidifier activation from room controller (one dehumidifier per room controller) via Uponor Smatrix Wave M-161 (relay module) registered to the room controller. Do not use a dehumidifier together with fancoils |
| P | <i>Optional</i> Heating/cooling activation from room controller via Uponor Smatrix Wave M-161 (relay module) |
| Q | <i>Optional</i> External heating/cooling switch via Uponor Smatrix Wave T-163 (public thermostat registered as system device to master room controller) |
| R | Heating/cooling relay, 230 V |
| S | Heat pump (which optionally can produce heating/cooling) |
| T | Wire for heating/cooling switchover Connected between master room controller (relay 2, boiler, configured to heating/cooling output) and heatpump (contact sensing input, configured for heating/cooling switch) |
| U | <i>Optional</i> Uponor Smatrix Wave M-161 (relay module), registered to the room controller connected to a contact sensing input, configured for heating/cooling switch, in the heat pump |
| V | Fancoils Supply and return lines connected to a cooling source. Registered to a room thermostat using a Uponor Smatrix Wave M-161 (relay module) |

Room temperature control

This application example shows underfloor heating or underfloor heating/cooling, and fancoils with a single room controller.

The room temperature (heating and/or cooling) is controlled by a single Uponor Smatrix Wave Pulse room controller and thermostats. The room controller regulate the flow to each room by operating the actuators on the underfloor manifold.

The relay modules are registered to the room thermostats (thermostat menu 9, Climatic controller integration), and the number of fancoils in the system are limited to the number of thermostats registered to the room controller.

See *Cooling with high protection to avoid condensation, Page 3* and *Cooling function, Page 6* for more information about setting up the system for cooling in the Uponor Smatrix Pulse app.

Heating/cooling switchover is done either in the Uponor Smatrix Pulse app (H/C master), automatically depending on supply line temperature or indoor/outdoor temperature (H/C master), or by the GPI (H/C slave).

Supply temperature control

The application example shows four different ways of controlling the supply temperature.

1 - Heating with Uponor Smatrix Move supply controller

The supply temperature is regulated using a supply temperature controller (Uponor Smatrix Move) with outdoor temperature sensor and heating curve.

Connected to the supply temperature controller is the master room controller, heat pump, circulation pump, supply temperature sensor, and 3 way mixing valve.

The master room controller connects from the circulation pump relay (relay 1) to one of the supply temperature controller ROOMSTAT input (setup as **C_b**). When the relay in the room controller closes, the supply temperature controller starts the circulation pump.

2 - Heating/cooling with heat pump



Note

This supply temperature control option requires a heat pump which can produce both heating and cooling.

The supply temperature (for both heating and cooling, if the heat pump can produce both) is regulated using a heat pump.

The master room controller connects from the circulation pump relay (relay 1) to the heat pump (to a relay for heat demand). When the relay in the room controller closes, the heat pump starts the circulation pump.

The master room controller also connects from the boiler relay (relay 2, setup as heating/cooling switch) to the heat pump (to a relay for heating/cooling switch). When the relay in the room controller closes, the heat pump switches to cooling.

Optionally, the heatpump can switch between heating and cooling using a wireless relay module, registered to the master room controller.

3 - Heating/cooling (switched from room controller) with Uponor Smatrix Move supply temperature controller

The supply temperature is regulated using a supply temperature controller (Uponor Smatrix Move) with outdoor temperature sensor and heating/cooling curves.

Connected to the supply temperature controller is the circulation pump, supply temperature sensor, 3 way mixing valve, and heating/cooling switchover valve. The heat source and chiller is controlled by a relay module registered to the master room controller.

With a registered wireless thermostat (requires antenna A-155), the Uponor Smatrix Move controller is be integrated with an Uponor Smatrix Wave Pulse system to enhance the capabilities of a full climate system. At the same time, the integration removes the need of a separate thermostat, and outdoor sensor (if connected to the Wave Pulse system), for the Move system.

Information regarding system state and reference room temperature is forwarded to the supply temperature controller, which adjusts the supply temperature accordingly.

Different system states and temperatures which can be forwarded are:

- Comfort/ECO mode*
- Heating/cooling mode
- Holiday mode*
- Reference room temperature and setpoint
- Outdoor temperature (if installed in the thermostat)

- Remote sensor (if installed in the thermostat)
- Indication if the relative humidity exceeds set limits (requires the digital thermostat T-168 or T-169, and communication module)

*) Through change of setpoint, using the ECO setback value from the integrated system. No indication or change of mode is shown in the Move controller.

Optionally, one dehumidifier (via relay module Uponor Smatrix Wave M-161) per room controller can be connected, and an external heating/cooling switch via Uponor Smatrix Wave T-163 (public thermostat as system device) can be registered to the master room controller. Do not use a dehumidifier together with fancoils.

4 - Heating/cooling with Uponor Smatrix Move supply temperature controller

The supply temperature is regulated using a supply temperature controller (Uponor Smatrix Move) with outdoor temperature sensor and heating/cooling curves.

Connected to the supply temperature controller is the heat source (via heating/cooling relay), chiller (via heating/cooling relay), circulation pump, supply temperature sensor, 3 way mixing valve, and heating/cooling switchover valve.

With a registered wireless thermostat (requires antenna A-155), the Uponor Smatrix Move controller is be integrated with an Uponor Smatrix Wave Pulse system to enhance the capabilities of a full

climate system. At the same time, the integration removes the need of a separate thermostat, and outdoor sensor (if connected to the Wave Pulse system), for the Move system.

Information regarding system state and reference room temperature is forwarded to the supply temperature controller, which adjusts the supply temperature accordingly.

Different system states and temperatures which can be forwarded are:

- Comfort/ECO mode*
- Heating/cooling mode
- Holiday mode*
- Reference room temperature and setpoint
- Outdoor temperature (if installed in the thermostat)
- Remote sensor (if installed in the thermostat)
- Indication if the relative humidity exceeds set limits (requires the digital thermostat T-168 or T-169, and communication module)

*) Through change of setpoint, using the ECO setback value from the integrated system. No indication or change of mode is shown in the Move controller.

Optionally, one dehumidifier (via relay module Uponor Smatrix Wave M-161) per room controller can be connected. Do not use a dehumidifier together with fancoils.

8.7 Underfloor heating with ceiling cooling, 2-pipe, and a single room controller

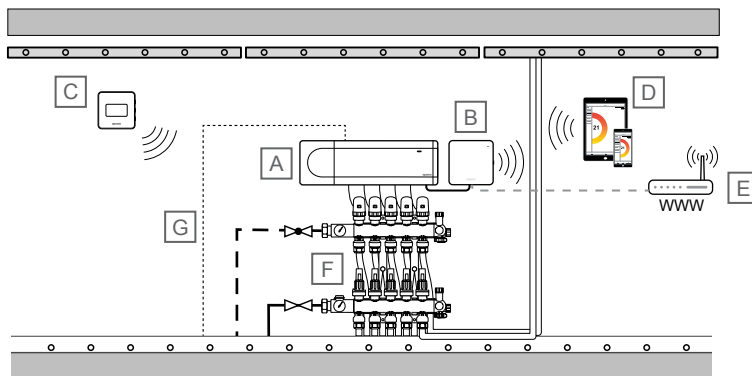

Note
These are outline diagrams. Real systems must be installed according to applicable norms and regulations.

| Item | Description |
|------|--|
| A | Uponor Smatrix Wave PULSE X-265 Room controller |
| B | Uponor Smatrix PULSE Com R-208 Communication module Connected to master room controller |
| C | Uponor Smatrix Wave T-169 Digital thermostat with relative humidity sensor and operative sensor |
| D | Mobile device (smartphone, tablet, etc) |
| E | Wi-Fi router |
| F | Manifold with actuator |

| Item | Description |
|------|--|
| G | Wire for heating/cooling switchover Connected from the master room controller (relay 2, boiler, configured to heating/cooling output) |

Room temperature control

This application example shows underfloor heating with ceiling cooling (2-pipe).

The room temperature is controlled by a single Uponor Smatrix Wave Pulse room controller and thermostat, with some actuators controlling the ceiling cooling. The room controller regulate room temperature by operating the actuators on the underfloor manifold.

See *Cooling with high protection to avoid condensation, Page 3* and *Cooling function, Page 6* for more information about setting up the system for cooling in the Uponor Smatrix Pulse app.

8.8 Underfloor heating with ceiling cooling, 4-pipe, and a single room controller

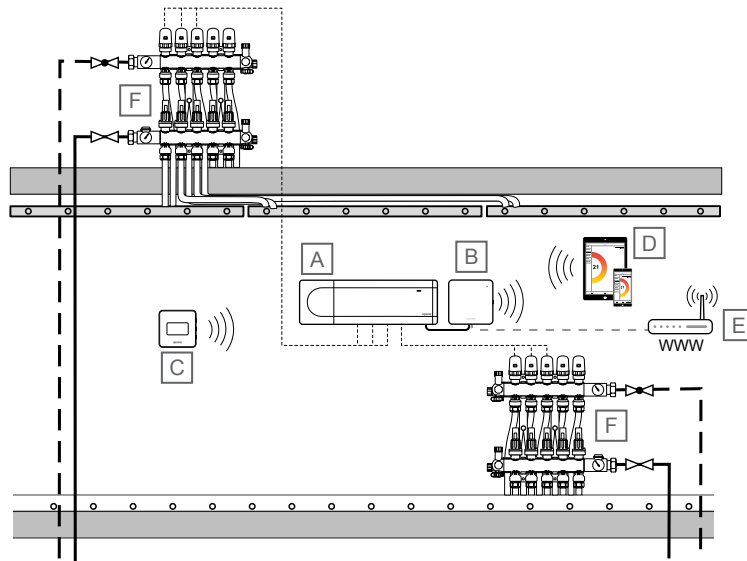

SD0000042

Note

These are outline diagrams. Real systems must be installed according to applicable norms and regulations.

| Item | Description |
|------|--|
| A | Uponor Smatrix Wave PULSE X-265 Room controller |
| B | Uponor Smatrix PULSE Com R-208 Communication module Connected to master room controller |
| C | Uponor Smatrix Wave T-169 Digital thermostat with relative humidity sensor and operative sensor |
| D | Mobile device (smartphone, tablet, etc) |

| Item | Description |
|------|------------------------|
| E | Wi-Fi router |
| F | Manifold with actuator |

Room temperature control

This application example shows underfloor heating with ceiling cooling (4-pipe).

The room temperature is controlled by a single Uponor Smatrix Wave Pulse room controller and thermostat. The room controller regulate room temperature by operating the actuators on two underfloor manifolds (one for underfloor heating, and one for ceiling cooling).

See *Cooling with high protection to avoid condensation*, Page 3 and *Cooling function*, Page 6 for more information about setting up the system for cooling in the Uponor Smatrix Pulse app.

8.9 Underfloor heating with extra loop in an additional room

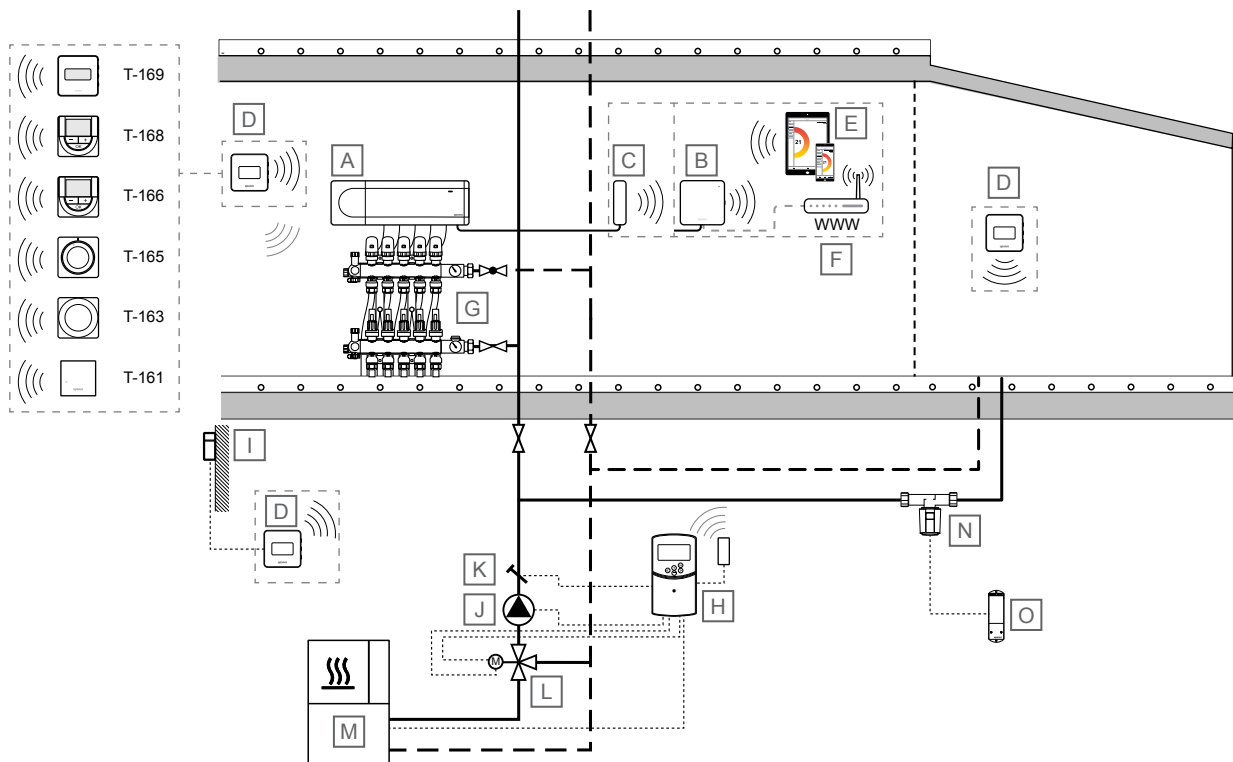

SD0000043

Note

These are outline diagrams. Real systems must be installed according to applicable norms and regulations.

| Item | Description |
|------|---|
| A | Uponor Smatrix Wave PULSE X-265 Room controller |
| B | Uponor Smatrix PULSE Com R-208 Communication module Connected to master room controller |
| C | Uponor Smatrix Wave PULSE A-265 Antenna |
| D | Room thermostat ^{1) 2)} <ul style="list-style-type: none"> Uponor Smatrix Wave T-161 Room sensor thermostat with relative humidity sensor and operative sensor Uponor Smatrix Wave T-163 Public thermostat Uponor Smatrix Wave T-165 Standard thermostat with print on dial Uponor Smatrix Wave T-166 Digital thermostat Uponor Smatrix Wave T-168 Programmable digital thermostat with relative humidity sensor Uponor Smatrix Wave T-169 Digital thermostat with relative humidity sensor and operative sensor |
| E | Mobile device (smartphone, tablet, etc) |
| F | Wi-Fi router |
| G | Manifold with actuator |
| H | Uponor Smatrix Move X-157 |

| Item | Description |
|------|--|
| | Supply temperature controller, with optional antenna (required if using room thermostat) |
| I | Outdoor temperature sensor |
| J | Circulation pump |
| K | Supply temperature sensor |
| L | 3 way mixing valve with 230 V 3-point actuator |
| M | Heat source |
| N | Valve with 230 V actuator |
| O | Uponor Smatrix Wave M-161 Relay module |

1) Only digital thermostats can be used when registering a relay module via thermostat menu 9 (Climatic controller integration).

2) The outdoor temperature sensor can only be connected to the public och digital thermostats.

Room temperature control

Note

The system can be operated without a communication module, with only an antenna attached to the room controller. But this will reduce the functionality of the system.

This application example shows underfloor heating with extra loop in an additional room. For example an extra loop is needed for an addition to the house etc.

The room temperature (heating and/or cooling) is controlled by a single Uponor Smatrix Wave Pulse room controller and thermostats. The room controller regulate the flow to each room by operating the actuators on the underfloor manifold. The flow to the extra loop is regulated from the room controller using a relay module (valve connected to relay 2 on the relay module). The relay module is registered to a room thermostat (thermostat menu 9, Climatic

controller integration) which already is registered to the room controller.

Supply temperature control

The supply temperature is regulated using a supply temperature controller (Uponor Smatrix Move) with outdoor temperature sensor (via thermostat) and heating curve.

Connected to the supply temperature controller is the heat pump, circulation pump, supply temperature sensor, and 3 way mixing valve.

With a registered wireless thermostat (requires antenna A-155), the Uponor Smatrix Move controller is be integrated with an Uponor Smatrix Wave Pulse system to enhance the capabilities of a full climate system. At the same time, the integration removes the need of a separate thermostat, and outdoor sensor (if connected to the Wave Pulse system), for the Move system.

Information regarding system state and reference room temperature is forwarded to the supply temperature controller, which adjusts the supply temperature accordingly.

Different system states and temperatures which can be forwarded are:

- Comfort/ECO mode*
- Heating/cooling mode
- Holiday mode*
- Reference room temperature and setpoint
- Outdoor temperature (if installed in the thermostat)
- Remote sensor (if installed in the thermostat)
- Indication if the relative humidity exceeds set limits (requires the digital thermostat T-168 or T-169, and communication module)

*) Through change of setpoint, using the ECO setback value from the integrated system. No indication or change of mode is shown in the Move controller.

8.10 Ceiling cooling with eg. Tichelmann loops

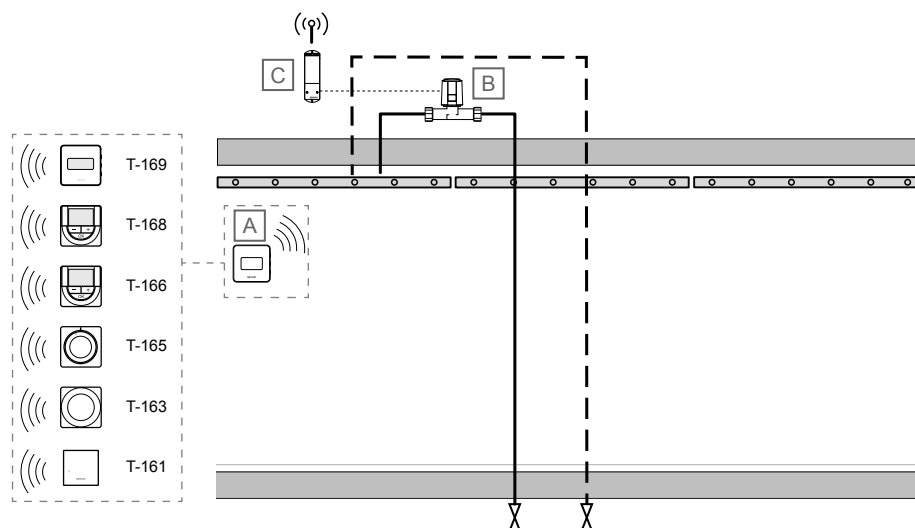

SD0000044

Note

These are outline diagrams. Real systems must be installed according to applicable norms and regulations.

| Item | Description |
|------|--|
| A | Room thermostat <ul style="list-style-type: none"> • Uponor Smatrix Wave T-166 Digital thermostat • Uponor Smatrix Wave T-168 Programmable digital thermostat with relative humidity sensor • Uponor Smatrix Wave T-169 Digital thermostat with relative humidity sensor and operative sensor |
| B | Valve with 230 V actuator |
| C | Uponor Smatrix Wave M-161 Relay module |

Room temperature control

Note

The first channel for this room needs to be configured for ceiling cooling in the Uponor Smatrix Pulse app.

This simplified application example shows ceiling cooling with eg. Tichelmann loops.

The room temperature is measured by an Uponor Smatrix thermostat and transmitted to an Uponor Smatrix Wave Pulse room controller. The room controller operates the actuator, which is connected to a relay module configured for heating/cooling switch to mirror the actuator output of the controller using one way radio.

See *Cooling with high protection to avoid condensation, Page 3 and Cooling function, Page 6* for more information about setting up the system for cooling in the Uponor Smatrix Pulse app.

Heating/cooling switchover is done either in the Uponor Smatrix Pulse app (H/C master), automatically depending on supply line temperature or indoor/outdoor temperature (H/C master), or by the GPI (H/C slave).

9 Application examples – Base Pulse

9.1 Underfloor heating or underfloor heating/cooling with multiple room controllers

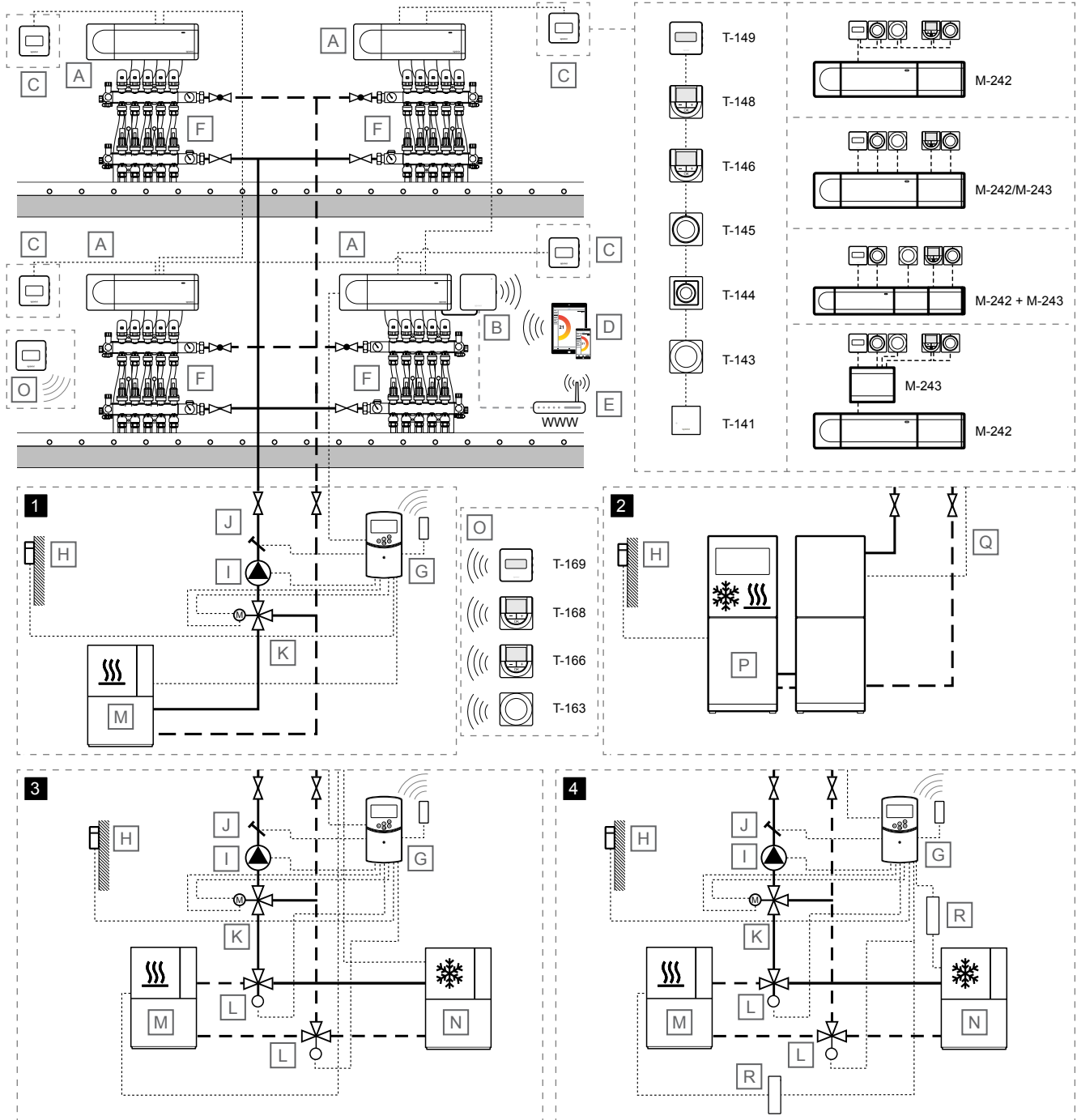

SD0000045

Note
These are outline diagrams. Real systems must be installed according to applicable norms and regulations.

| Item | Description |
|------|---------------------------------|
| A | Uponor Smatrix Base PULSE X-245 |

| Item | Description |
|------|---|
| | Room controller |
| B | Uponor Smatrix PULSE Com R-208 Communication module Connected to master room controller |

| Item | Description |
|------|--|
| C | Room thermostat <ul style="list-style-type: none"> Uponor Smatrix Base T-141 Room sensor thermostat with relative humidity sensor and operative sensor Uponor Smatrix Base T-143 Public thermostat Uponor Smatrix Base T-144 Flush thermostat Uponor Smatrix Base T-145 Standard thermostat with print on dial Uponor Smatrix Base T-146 Digital thermostat Uponor Smatrix Base T-148 Programmable digital thermostat with relative humidity sensor Uponor Smatrix Base T-149 Digital thermostat with relative humidity sensor and operative sensor |
| | Expansion module <ul style="list-style-type: none"> Uponor Smatrix Base M-242 Slave module Uponor Smatrix Base M-243 Star module |
| D | Mobile device (smartphone, tablet, etc) |
| E | Wi-Fi router |
| F | Manifold with actuator |
| G | Uponor Smatrix Move X-157 Supply temperature controller, with optional antenna (required if using room thermostat) |
| H | Outdoor temperature sensor |
| I | Circulation pump |
| J | Supply temperature sensor |
| K | 3 way mixing valve with 230 V 3-point actuator |
| L | Heating/cooling switchover valve with 230 V actuator |
| M | Heat source |
| N | Chiller |
| O | Wireless room thermostat for supply temperature calculation <ul style="list-style-type: none"> Uponor Smatrix Wave T-163 Public thermostat Uponor Smatrix Wave T-166 Digital thermostat Uponor Smatrix Wave T-168 Programmable digital thermostat with relative humidity sensor Uponor Smatrix Wave T-169 Digital thermostat with relative humidity sensor and operative sensor |
| P | Heat pump (which optionally can produce heating/cooling) |
| Q | Wire for heating/cooling switchover Connected between master room controller (relay 2, boiler, configured to heating/cooling output) and heatpump (contact sensing input, configured for heating/cooling switch) |
| R | Heating/cooling relay, 230 V |

Room temperature control

This application example shows underfloor heating, or underfloor heating/cooling, with multiple sub room controllers.

The room temperature (heating and/or cooling) is controlled by four Uponor Smatrix Base Pulse room controllers and thermostats merged into one large system (one master room controller together with three sub room controllers). The room controllers regulate the

flow to each room by operating the actuators on the underfloor manifold.

The system is based on a bus communications protocol (requires the thermostats unique ID to be registered to the controller), utilising daisy chain, direct or star topology connections. This allows serial and parallel connections, making wiring and connection of thermostats and system devices much easier than connecting one thermostat per connection terminal.

The wide array of connection possibilities presented with this communications protocol can be combined in any way best suited for the current system.

The master room controller is selected by connecting the communication module to it. Only one communication module per system can be connected, and the sub room controllers communicate with the master room controller via the same bus communications protocol as the thermostats (but via the system bus connections). See *Uponor Smatrix Base Pulse, Page 31* for more information about how to communicate with the communication module.

See *Cooling with high protection to avoid condensation, Page 3* and *Cooling function, Page 6* for more information about setting up the system for cooling in the Uponor Smatrix Pulse app.

Heating/cooling switchover is done either in the Uponor Smatrix Pulse app (H/C master), automatically depending on supply line temperature or indoor/outdoor temperature (H/C master), or by the GPI (H/C slave).

Supply temperature control

The application example shows four different ways of controlling the supply temperature.

1 - Heating with Uponor Smatrix Move supply controller

The supply temperature is regulated using a supply temperature controller (Uponor Smatrix Move) with outdoor temperature sensor and heating curve.

Connected to the supply temperature controller is the master room controller, heat pump, circulation pump, supply temperature sensor, and 3 way mixing valve.

The master room controller connects from the circulation pump relay (relay 1) to one of the supply temperature controller ROOMSTAT input (setup as **C_b**). When the relay in the room controller closes, the supply temperature controller starts the circulation pump.

With an external antenna Uponor Smatrix Move can use different types of thermostats to regulate heating and cooling in the system. Designed for maximum comfort, the thermostats communicate with the controller by radio link. It is possible to mix a maximum of two different types of Uponor Smatrix Wave thermostats in the same installation. One of these thermostats though can only function as a wireless connection point for the outdoor temperature sensor.

2 - Heating/cooling with heat pump



Note
This supply temperature control option requires a heat pump which can produce both heating and cooling.

The supply temperature (for both heating and cooling, if the heat pump can produce both) is regulated using a heat pump.

The master room controller connects from the circulation pump relay (relay 1) to the heat pump (to a relay for heat demand). When the relay in the room controller closes, the heat pump starts the circulation pump.

The master room controller also connects from the boiler relay (relay 2, setup as heating/cooling switch) to the heat pump (to a relay for heating/cooling switch). When the relay in the room controller closes, the heat pump switches to cooling.

3 - Heating/cooling (switched from room controller) with Uponor Smatrix Move supply temperature controller

The supply temperature is regulated using a supply temperature controller (Uponor Smatrix Move) with outdoor temperature sensor and heating/cooling curves.

Connected to the supply temperature controller is the circulation pump, supply temperature sensor, 3 way mixing valve, and heating/cooling switchover valve. The heat source and chiller is controlled by a relay module registered to the master room controller.

The master room controller connects from the circulation pump relay (relay 1) to one of the supply temperature controller ROOMSTAT input (setup as **C_b**). When the relay in the room controller closes, the supply temperature controller starts the circulation pump.

The master room controller also connects from the boiler relay (relay 2, setup as heating/cooling switch) to one of the supply temperature controller ROOMSTAT input (setup as **HC**). When the relay in the room controller closes, the supply temperature controller starts the circulation pump.

With an external antenna Uponor Smatrix Move can use different types of thermostats to regulate heating and cooling in the system. Designed for maximum comfort, the thermostats communicate with the controller by radio link. It is possible to mix a maximum of two different types of Uponor Smatrix Wave thermostats in the same installation. One of these thermostats though can only function as a wireless connection point for the outdoor temperature sensor.

4 - Heating/cooling with Uponor Smatrix Move supply temperature controller

The supply temperature is regulated using a supply temperature controller (Uponor Smatrix Move) with outdoor temperature sensor and heating/cooling curves.

Connected to the supply temperature controller is the heat source (via heating/cooling relay), chiller (via heating/cooling relay), circulation pump, supply temperature sensor, 3 way mixing valve, and heating/cooling switchover valve.

The master room controller connects from the circulation pump relay (relay 1) to one of the supply temperature controller ROOMSTAT input (setup as **C_b**). When the relay in the room controller closes, the supply temperature controller starts the circulation pump.

The master room controller also connects from the boiler relay (relay 2, setup as heating/cooling switch) to one of the supply temperature controller ROOMSTAT input (setup as **HC**). When the relay in the room controller closes, the supply temperature controller starts the circulation pump.

With an external antenna Uponor Smatrix Move can use different types of thermostats to regulate heating and cooling in the system. Designed for maximum comfort, the thermostats communicate with the controller by radio link. It is possible to mix a maximum of two different types of Uponor Smatrix Wave thermostats in the same installation. One of these thermostats though can only function as a wireless connection point for the outdoor temperature sensor.

9.2 Underfloor heating or underfloor heating/cooling with a single room controller

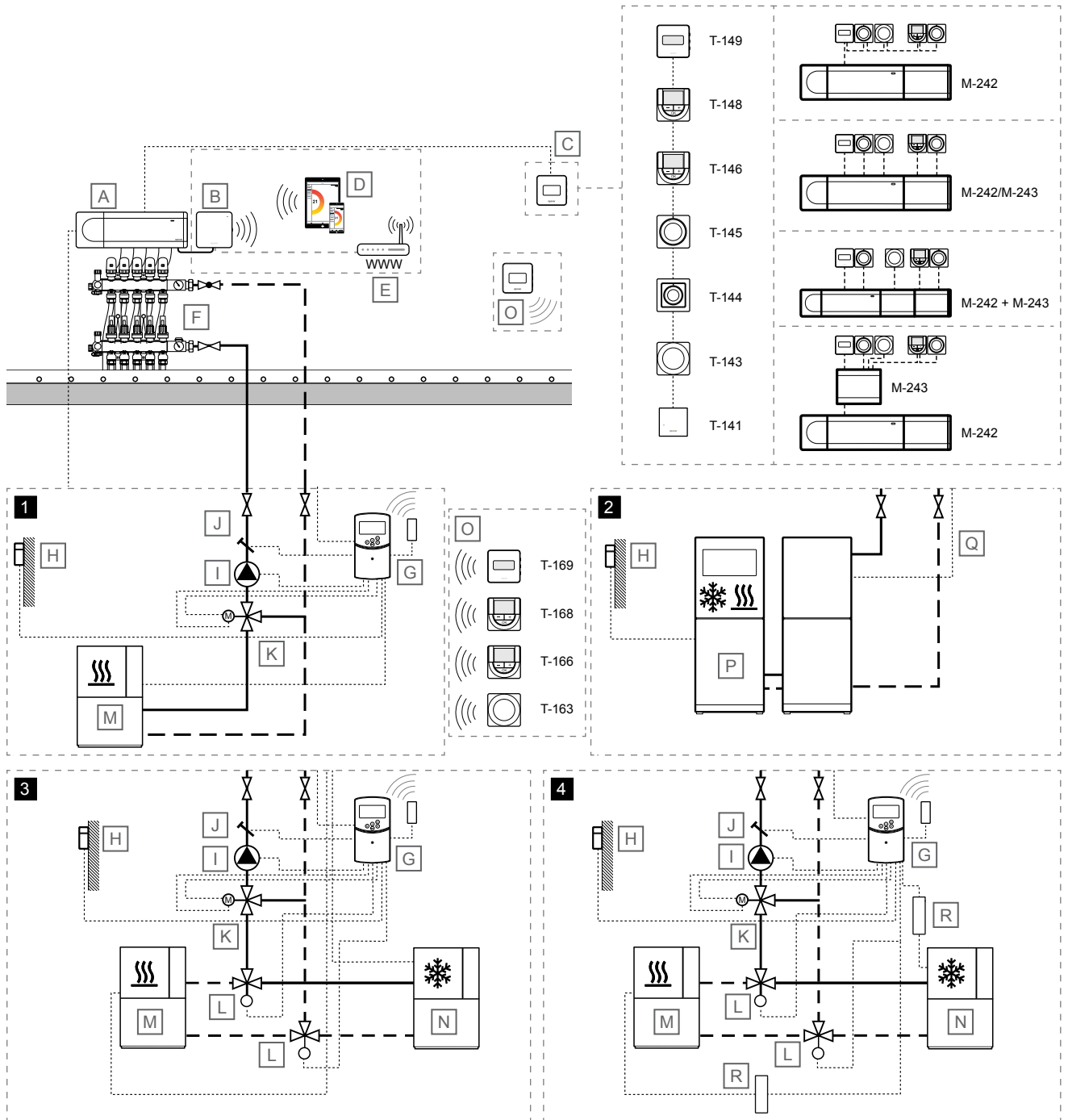

SD000046

| Note | |
|---|--|
| These are outline diagrams. Real systems must be installed according to applicable norms and regulations. | |
| Item | Description |
| A | Uponor Smatrix Base PULSE X-245 Room controller |
| B | Uponor Smatrix PULSE Com R-208 Communication module |

| Item | Description |
|------|-------------------------------------|
| | Connected to master room controller |

| Item | Description |
|------|--|
| C | Room thermostat <ul style="list-style-type: none"> • Uponor Smatrix Base T-141 Room sensor thermostat with relative humidity sensor and operative sensor • Uponor Smatrix Base T-143 Public thermostat • Uponor Smatrix Base T-144 Flush thermostat • Uponor Smatrix Base T-145 Standard thermostat with print on dial • Uponor Smatrix Base T-146 Digital thermostat • Uponor Smatrix Base T-148 Programmable digital thermostat with relative humidity sensor • Uponor Smatrix Base T-149 Digital thermostat with relative humidity sensor and operative sensor |
| | Expansion module <ul style="list-style-type: none"> • Uponor Smatrix Base M-242 Slave module • Uponor Smatrix Base M-243 Star module |
| D | Mobile device (smartphone, tablet, etc) |
| E | Wi-Fi router |
| F | Manifold with actuator |
| G | Uponor Smatrix Move X-157 Supply temperature controller, with optional antenna (required if using room thermostat) |
| H | Outdoor temperature sensor |
| I | Circulation pump |
| J | Supply temperature sensor |
| K | 3 way mixing valve with 230 V 3-point actuator |
| L | Heating/cooling switchover valve with 230 V actuator |
| M | Heat source |
| N | Chiller |
| O | Wireless room thermostat for supply temperature calculation <ul style="list-style-type: none"> • Uponor Smatrix Wave T-163 Public thermostat • Uponor Smatrix Wave T-166 Digital thermostat • Uponor Smatrix Wave T-168 Programmable digital thermostat with relative humidity sensor • Uponor Smatrix Wave T-169 Digital thermostat with relative humidity sensor and operative sensor |
| P | Heat pump (which optionally can produce heating/cooling) |
| Q | Wire for heating/cooling switchover Connected between master room controller (relay 2, boiler, configured to heating/cooling output) and heatpump (contact sensing input, configured for heating/cooling switch) |
| R | Heating/cooling relay, 230 V |

Room temperature control



Caution!

The communication module is required for use with **Supply temperature control 2 - 4**.



Note

The system can be operated without a communication module. But this will reduce the functionality of the system.

This application example shows underfloor heating, or underfloor heating/cooling, with a single room controller.

The room temperature (heating and/or cooling) is controlled by a single Uponor Smatrix Base Pulse room controller and thermostats. The room controller regulate the flow to each room by operating the actuators on the underfloor manifold.

The system is based on a bus communications protocol (requires the thermostats unique ID to be registered to the controller), utilising daisy chain, direct or star topology connections. This allows serial and parallel connections, making wiring and connection of thermostats and system devices much easier than connecting one thermostat per connection terminal.

The wide array of connection possibilities presented with this communications protocol can be combined in any way best suited for the current system.

See *Cooling with high protection to avoid condensation, Page 3* and *Cooling function, Page 6* for more information about setting up the system for cooling in the Uponor Smatrix Pulse app.

Heating/cooling switchover is done either in the Uponor Smatrix Pulse app (H/C master), automatically depending on supply line temperature or indoor/outdoor temperature (H/C master), or by the GPI (H/C slave).

Supply temperature control

The application example shows four different ways of controlling the supply temperature.

1 - Heating with Uponor Smatrix Move supply controller

The supply temperature is regulated using a supply temperature controller (Uponor Smatrix Move) with outdoor temperature sensor and heating curve.

Connected to the supply temperature controller is the master room controller, heat pump, circulation pump, supply temperature sensor, and 3 way mixing valve.

The master room controller connects from the circulation pump relay (relay 1) to one of the supply temperature controller ROOMSTAT input (setup as **C_b**). When the relay in the room controller closes, the supply temperature controller starts the circulation pump.

With an external antenna Uponor Smatrix Move can use different types of thermostats to regulate heating and cooling in the system. Designed for maximum comfort, the thermostats communicate with the controller by radio link. It is possible to mix a maximum of two different types of Uponor Smatrix Wave thermostats in the same installation. One of these thermostats though can only function as a wireless connection point for the outdoor temperature sensor.

2 - Heating/cooling with heat pump



Note

This supply temperature control option requires a heat pump which can produce both heating and cooling.

The supply temperature (for both heating and cooling, if the heat pump can produce both) is regulated using a heat pump.

The master room controller connects from the circulation pump relay (relay 1) to the heat pump (to a relay for heat demand). When the relay in the room controller closes, the heat pump starts the circulation pump.

The master room controller also connects from the boiler relay (relay 2, setup as heating/cooling switch) to the heat pump (to a relay for heating/cooling switch). When the relay in the room controller closes, the heat pump switches to cooling.

3 - Heating/cooling (switched from room controller) with Uponor Smatrix Move supply temperature controller

The supply temperature is regulated using a supply temperature controller (Uponor Smatrix Move) with outdoor temperature sensor and heating/cooling curves.

Connected to the supply temperature controller is the circulation pump, supply temperature sensor, 3 way mixing valve, and heating/cooling switchover valve. The heat source and chiller is controlled by a relay module registered to the master room controller.

The master room controller connects from the circulation pump relay (relay 1) to one of the supply temperature controller ROOMSTAT input (setup as **C_b**). When the relay in the room controller closes, the supply temperature controller starts the circulation pump.

The master room controller also connects from the boiler relay (relay 2, setup as heating/cooling switch) to one of the supply temperature controller ROOMSTAT input (setup as **HC**). When the relay in the room controller closes, the supply temperature controller starts the circulation pump.

With an external antenna Uponor Smatrix Move can use different types of thermostats to regulate heating and cooling in the system.

Designed for maximum comfort, the thermostats communicate with the controller by radio link. It is possible to mix a maximum of two different types of Uponor Smatrix Wave thermostats in the same installation. One of these thermostats though can only function as a wireless connection point for the outdoor temperature sensor.

4 - Heating/cooling with Uponor Smatrix Move supply temperature controller

The supply temperature is regulated using a supply temperature controller (Uponor Smatrix Move) with outdoor temperature sensor and heating/cooling curves.

Connected to the supply temperature controller is the heat source (via heating/cooling relay), chiller (via heating/cooling relay), circulation pump, supply temperature sensor, 3 way mixing valve, and heating/cooling switchover valve.

The master room controller connects from the circulation pump relay (relay 1) to one of the supply temperature controller ROOMSTAT input (setup as **C_b**). When the relay in the room controller closes, the supply temperature controller starts the circulation pump.

The master room controller also connects from the boiler relay (relay 2, setup as heating/cooling switch) to one of the supply temperature controller ROOMSTAT input (setup as **HC**). When the relay in the room controller closes, the supply temperature controller starts the circulation pump.

With an external antenna Uponor Smatrix Move can use different types of thermostats to regulate heating and cooling in the system. Designed for maximum comfort, the thermostats communicate with the controller by radio link. It is possible to mix a maximum of two different types of Uponor Smatrix Wave thermostats in the same installation. One of these thermostats though can only function as a wireless connection point for the outdoor temperature sensor.

9.3 Underfloor heating/cooling with two stand alone room controllers

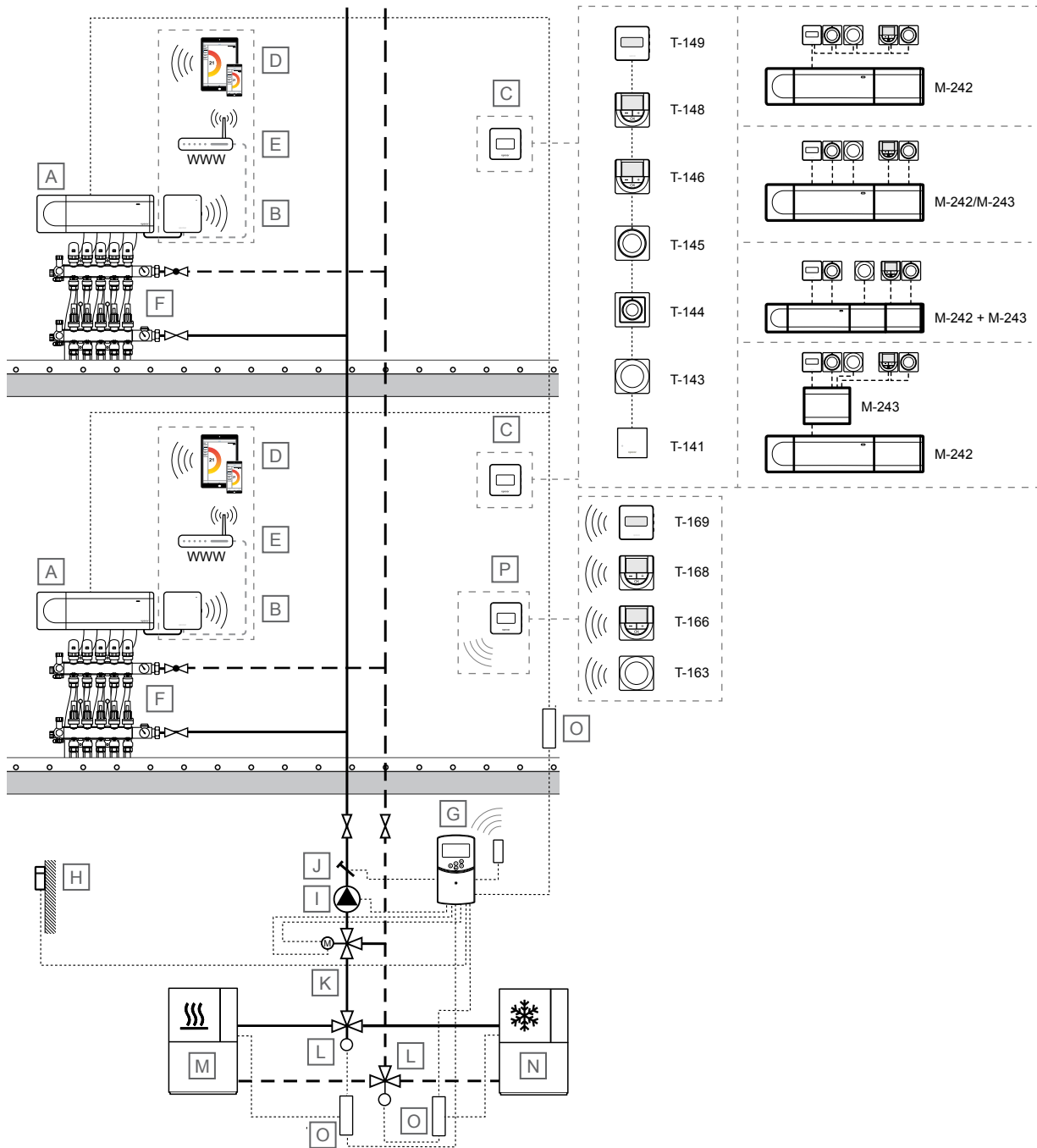

SD0000047

Note

These are outline diagrams. Real systems must be installed according to applicable norms and regulations.

| Item | Description |
|------|---|
| A | Uponor Smatrix Base PULSE X-245 Room controller |
| B | Uponor Smatrix PULSE Com R-208 Communication module Connected to master room controller |
| C | Room thermostat <ul style="list-style-type: none"> • Uponor Smatrix Base T-141 |

| Item | Description |
|------|---|
| | Room sensor thermostat with relative humidity sensor and operative sensor |
| | • Uponor Smatrix Base T-143 Public thermostat |
| | • Uponor Smatrix Base T-144 Flush thermostat |
| | • Uponor Smatrix Base T-145 Standard thermostat with print on dial |
| | • Uponor Smatrix Base T-146 Digital thermostat |
| | • Uponor Smatrix Base T-148 |

| Item | Description |
|------|--|
| | Programmable digital thermostat with relative humidity sensor |
| | <ul style="list-style-type: none"> • Uponor Smatrix Base T-149 |
| | Digital thermostat with relative humidity sensor and operative sensor |
| | Expansion module |
| | <ul style="list-style-type: none"> • Uponor Smatrix Base M-242 |
| | Slave module |
| | <ul style="list-style-type: none"> • Uponor Smatrix Base M-243 |
| | Star module |
| D | Mobile device (smartphone, tablet, etc) |
| E | Wi-Fi router |
| F | Manifold with actuator |
| G | Uponor Smatrix Move X-157 |
| | Supply temperature controller, with optional antenna (required if using room thermostat) |
| H | Outdoor temperature sensor |
| I | Circulation pump |
| J | Supply temperature sensor |
| K | 3 way mixing valve with 230 V 3-point actuator |
| L | Heating/cooling switchover valve with 230 V actuator |
| M | Heat source |
| N | Chiller |
| O | Heating/cooling relay, 230 V |
| P | Wireless room thermostat for supply temperature calculation |
| | <ul style="list-style-type: none"> • Uponor Smatrix Wave T-163 |
| | Public thermostat |
| | <ul style="list-style-type: none"> • Uponor Smatrix Wave T-166 |
| | Digital thermostat |
| | <ul style="list-style-type: none"> • Uponor Smatrix Wave T-168 |
| | Programmable digital thermostat with relative humidity sensor |
| | <ul style="list-style-type: none"> • Uponor Smatrix Wave T-169 |
| | Digital thermostat with relative humidity sensor and operative sensor |

Room temperature control

Note

The system can be operated without a communication module. But this will reduce the functionality of the system.

This application example shows underfloor heating/cooling with two stand alone room controllers.

The room temperature (heating and/or cooling) in each system is controlled by a single Uponor Smatrix Base Pulse room controller and thermostats. The room controller regulate the flow to each room by operating the actuators on the underfloor manifold. Both systems use the same supply line.

The system is based on a bus communications protocol (requires the thermostats unique ID to be registered to the controller), utilising daisy chain, direct or star topology connections. This allows serial and parallel connections, making wiring and connection of thermostats and system devices much easier than connecting one thermostat per connection terminal.

The wide array of connection possibilities presented with this communications protocol can be combined in any way best suited for the current system.

See *Cooling with high protection to avoid condensation, Page 3* and *Cooling function, Page 6* for more information about setting up the system for cooling in the Uponor Smatrix Pulse app.

Heating/cooling switchover is done either in the Uponor Smatrix Pulse app (H/C master), automatically depending on supply line temperature or indoor/outdoor temperature (H/C master), or by the GPI (H/C slave).

Supply temperature control

The supply temperature is regulated using a supply temperature controller (Uponor Smatrix Move) with outdoor temperature sensor and heating/cooling curves.

Connected to the supply temperature controller is the heat source (via heating/cooling relay), chiller (via heating/cooling relay), circulation pump, supply temperature sensor, 3 way mixing valve, and heating/cooling switchover valve.

The master room controller connects from the circulation pump relay (relay 1) to one of the supply temperature controller ROOMSTAT input (setup as **C_b**). When the relay in the room controller closes, the supply temperature controller starts the circulation pump.

The master room controller also connects from the boiler relay (relay 2, setup as heating/cooling switch) to one of the supply temperature controller ROOMSTAT input (setup as **HC**). When the relay in the room controller closes, the supply temperature controller starts the circulation pump.

With an external antenna Uponor Smatrix Move can use different types of thermostats to regulate heating and cooling in the system. Designed for maximum comfort, the thermostats communicate with the controller by radio link. It is possible to mix a maximum of two different types of Uponor Smatrix Wave thermostats in the same installation. One of these thermostats though can only function as a wireless connection point for the outdoor temperature sensor.

9.4 Underfloor heating or underfloor heating/cooling, and electrical underfloor heating with a single room controller

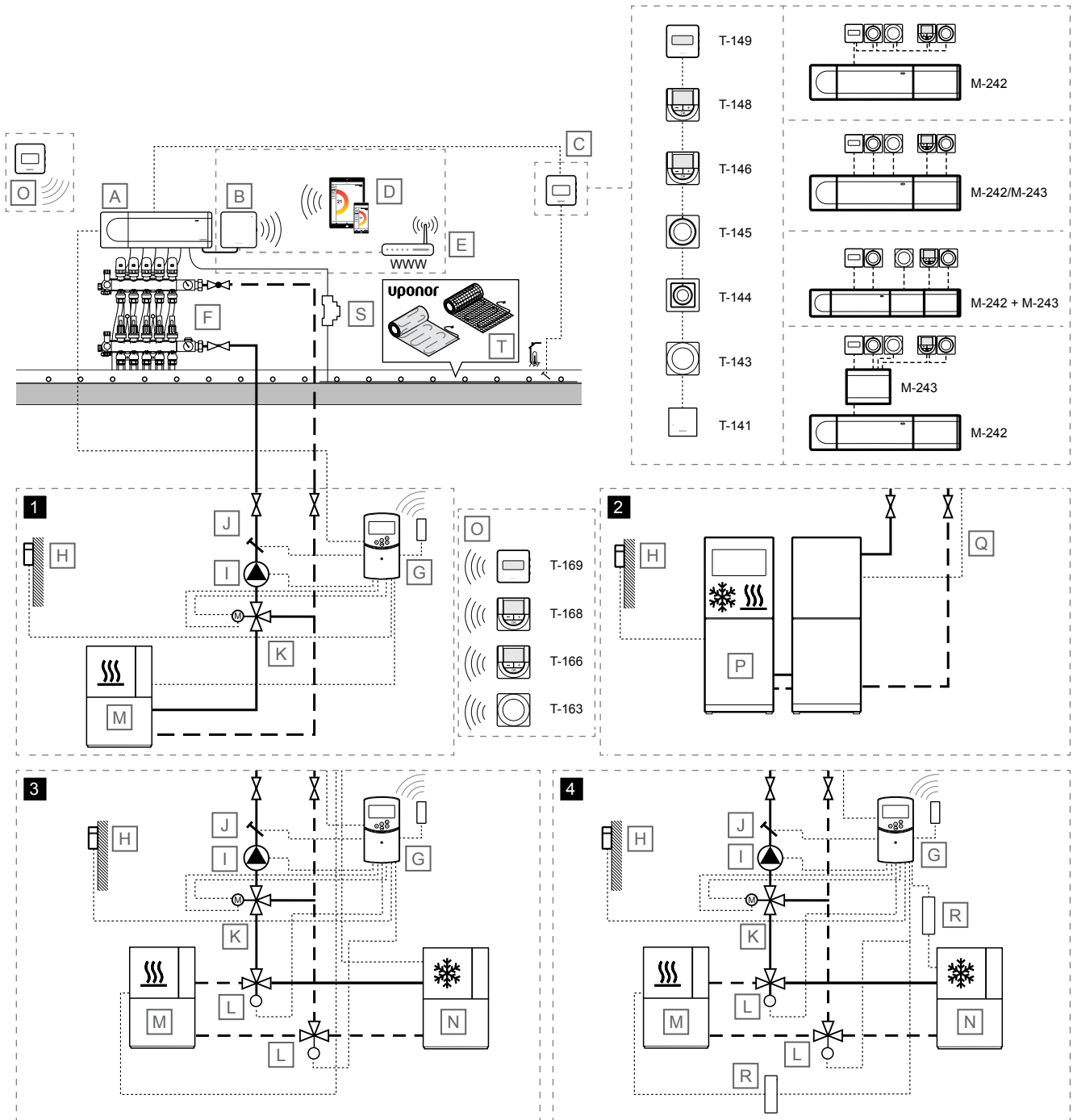

SD000048

| Note | |
|---|--|
| These are outline diagrams. Real systems must be installed according to applicable norms and regulations. | |
| Item | Description |
| A | Uponor Smatrix Base PULSE X-245 Room controller |
| B | Uponor Smatrix PULSE Com R-208 Communication module |

| Item | Description |
|------|-------------------------------------|
| | Connected to master room controller |

| Item | Description |
|------|--|
| C | Room thermostat <ul style="list-style-type: none"> • Uponor Smatrix Base T-141 Room sensor thermostat with relative humidity sensor and operative sensor • Uponor Smatrix Base T-143 Public thermostat • Uponor Smatrix Base T-144 Flush thermostat • Uponor Smatrix Base T-145 Standard thermostat with print on dial • Uponor Smatrix Base T-146 Digital thermostat • Uponor Smatrix Base T-148 Programmable digital thermostat with relative humidity sensor • Uponor Smatrix Base T-149 Digital thermostat with relative humidity sensor and operative sensor |
| | Expansion module <ul style="list-style-type: none"> • Uponor Smatrix Base M-242 Slave module • Uponor Smatrix Base M-243 Star module |
| D | Mobile device (smartphone, tablet, etc) |
| E | Wi-Fi router |
| F | Manifold with actuator |
| G | Uponor Smatrix Move X-157 Supply temperature controller, with optional antenna (required if using room thermostat) |
| H | Outdoor temperature sensor |
| I | Circulation pump |
| J | Supply temperature sensor |
| K | 3 way mixing valve with 230 V 3-point actuator |
| L | Heating/cooling switchover valve with 230 V actuator |
| M | Heat source |
| N | Chiller |
| O | Wireless room thermostat for supply temperature calculation <ul style="list-style-type: none"> • Uponor Smatrix Wave T-163 Public thermostat • Uponor Smatrix Wave T-166 Digital thermostat • Uponor Smatrix Wave T-168 Programmable digital thermostat with relative humidity sensor • Uponor Smatrix Wave T-169 Digital thermostat with relative humidity sensor and operative sensor |
| P | Heat pump (which optionally can produce heating/cooling) |
| Q | Wire for heating/cooling switchover Connected between master room controller (relay 2, boiler, configured to heating/cooling output) and heatpump (contact sensing input, configured for heating/cooling switch) |
| R | Heating/cooling relay, 230 V |
| S | 24 V AC relay (dimensioned for the correct load) |
| T | Uponor electrical heating cable mat |

Room temperature control



Caution!

The communication module is required for this solution, because the room with electrical underfloor heating must be set to "Cooling not allowed" in the Uponor Smatrix Pulse app.

This application example shows underfloor heating or underfloor heating/cooling, and electrical underfloor heating with a single room controller.

The room temperature (heating and/or cooling) is controlled by a single Uponor Smatrix Base Pulse room controller and thermostats. The room controller regulate the flow to each room by operating the actuators on the underfloor manifold. It also operate the electrical underfloor heating mats (connected to the room controller acuator connections, via a 24 V AC relay dimensioned for the correct load).

The system is based on a bus communications protocol (requires the thermostats unique ID to be registered to the controller), utilising daisy chain, direct or star topology connections. This allows serial and parallel connections, making wiring and connection of thermostats and system devices much easier than connecting one thermostat per connection terminal.

The wide array of connection possibilities presented with this communications protocol can be combined in any way best suited for the current system.

See *Cooling with high protection to avoid condensation, Page 3* and *Cooling function, Page 6* for more information about setting up the system for cooling in the Uponor Smatrix Pulse app.

Heating/cooling switchover is done either in the Uponor Smatrix Pulse app (H/C master), automatically depending on supply line temperature or indoor/outdoor temperature (H/C master), or by the GPI (H/C slave).

Supply temperature control

The application example shows four different ways of controlling the supply temperature.

1 - Heating with Uponor Smatrix Move supply controller

The supply temperature is regulated using a supply temperature controller (Uponor Smatrix Move) with outdoor temperature sensor and heating curve.

Connected to the supply temperature controller is the master room controller, heat pump, circulation pump, supply temperature sensor, and 3 way mixing valve.

The master room controller connects from the circulation pump relay (relay 1) to one of the supply temperature controller ROOMSTAT input (setup as **C_b**). When the relay in the room controller closes, the supply temperature controller starts the circulation pump.

With an external antenna Uponor Smatrix Move can use different types of thermostats to regulate heating and cooling in the system. Designed for maximum comfort, the thermostats communicate with the controller by radio link. It is possible to mix a maximum of two different types of Uponor Smatrix Wave thermostats in the same installation. One of these thermostats though can only function as a wireless connection point for the outdoor temperature sensor.

2 - Heating/cooling with heat pump



Note

This supply temperature control option requires a heat pump which can produce both heating and cooling.

The supply temperature (for both heating and cooling, if the heat pump can produce both) is regulated using a heat pump.

The master room controller connects from the circulation pump relay (relay 1) to the heat pump (to a relay for heat demand). When the relay in the room controller closes, the heat pump starts the circulation pump.

The master room controller also connects from the boiler relay (relay 2, setup as heating/cooling switch) to the heat pump (to a relay for heating/cooling switch). When the relay in the room controller closes, the heat pump switches to cooling.

3 - Heating/cooling (switched from room controller) with Uponor Smatrix Move supply temperature controller

The supply temperature is regulated using a supply temperature controller (Uponor Smatrix Move) with outdoor temperature sensor and heating/cooling curves.

Connected to the supply temperature controller is the circulation pump, supply temperature sensor, 3 way mixing valve, and heating/cooling switchover valve. The heat source and chiller is controlled by a relay module registered to the master room controller.

The master room controller connects from the circulation pump relay (relay 1) to one of the supply temperature controller ROOMSTAT input (setup as **C_b**). When the relay in the room controller closes, the supply temperature controller starts the circulation pump.

The master room controller also connects from the boiler relay (relay 2, setup as heating/cooling switch) to one of the supply temperature controller ROOMSTAT input (setup as **HC**). When the relay in the room controller closes, the supply temperature controller starts the circulation pump.

With an external antenna Uponor Smatrix Move can use different types of thermostats to regulate heating and cooling in the system.

Designed for maximum comfort, the thermostats communicate with the controller by radio link. It is possible to mix a maximum of two different types of Uponor Smatrix Wave thermostats in the same installation. One of these thermostats though can only function as a wireless connection point for the outdoor temperature sensor.

4 - Heating/cooling with Uponor Smatrix Move supply temperature controller

The supply temperature is regulated using a supply temperature controller (Uponor Smatrix Move) with outdoor temperature sensor and heating/cooling curves.

Connected to the supply temperature controller is the heat source (via heating/cooling relay), chiller (via heating/cooling relay), circulation pump, supply temperature sensor, 3 way mixing valve, and heating/cooling switchover valve.

The master room controller connects from the circulation pump relay (relay 1) to one of the supply temperature controller ROOMSTAT input (setup as **C_b**). When the relay in the room controller closes, the supply temperature controller starts the circulation pump.

The master room controller also connects from the boiler relay (relay 2, setup as heating/cooling switch) to one of the supply temperature controller ROOMSTAT input (setup as **HC**). When the relay in the room controller closes, the supply temperature controller starts the circulation pump.

With an external antenna Uponor Smatrix Move can use different types of thermostats to regulate heating and cooling in the system. Designed for maximum comfort, the thermostats communicate with the controller by radio link. It is possible to mix a maximum of two different types of Uponor Smatrix Wave thermostats in the same installation. One of these thermostats though can only function as a wireless connection point for the outdoor temperature sensor.

9.5 Underfloor heating with ceiling cooling, 2-pipe

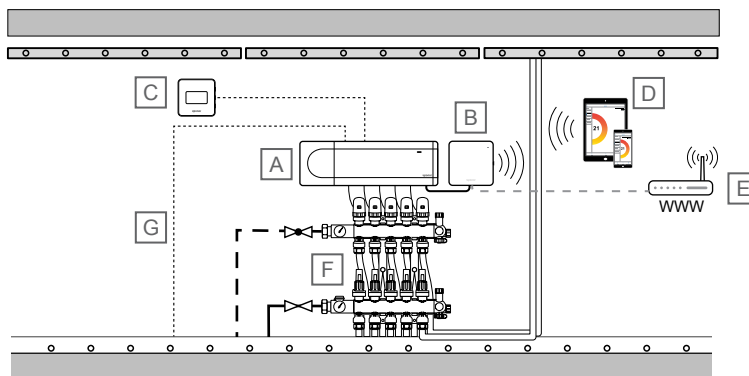

SD0000059

| Item | Description |
|------|--|
| A | Uponor Smatrix Base PULSE X-245 Room controller |
| B | Uponor Smatrix PULSE Com R-208 Communication module Connected to master room controller |
| C | Uponor Smatrix Base T-149 Digital thermostat with relative humidity sensor and operative sensor |
| D | Mobile device (smartphone, tablet, etc) |
| E | Wi-Fi router |

Note

These are outline diagrams. Real systems must be installed according to applicable norms and regulations.

| Item | Description |
|------|--|
| F | Manifold with actuator |
| G | Wire for heating/cooling switchover Connected from the master room controller (relay 2, boiler, configured to heating/cooling output) |

Room temperature control

This application example shows underfloor heating with ceiling cooling (2-pipe).

The room temperature is controlled by a single Uponor Smatrix Base Pulse room controller and thermostat, with some actuators controlling the ceiling cooling. The room controller regulate room temperature by operating the actuators on the underfloor manifold.

The system is based on a bus communications protocol (requires the thermostats unique ID to be registered to the controller), utilising daisy chain, direct or star topology connections. This allows serial

and parallel connections, making wiring and connection of thermostats and system devices much easier than connecting one thermostat per connection terminal.

The wide array of connection possibilities presented with this communications protocol can be combined in any way best suited for the current system.

See *Cooling with high protection to avoid condensation, Page 3* and *Cooling function, Page 6* for more information about setting up the system for cooling in the Uponor Smatrix Pulse app.

9.6 Underfloor heating with ceiling cooling, 4-pipe

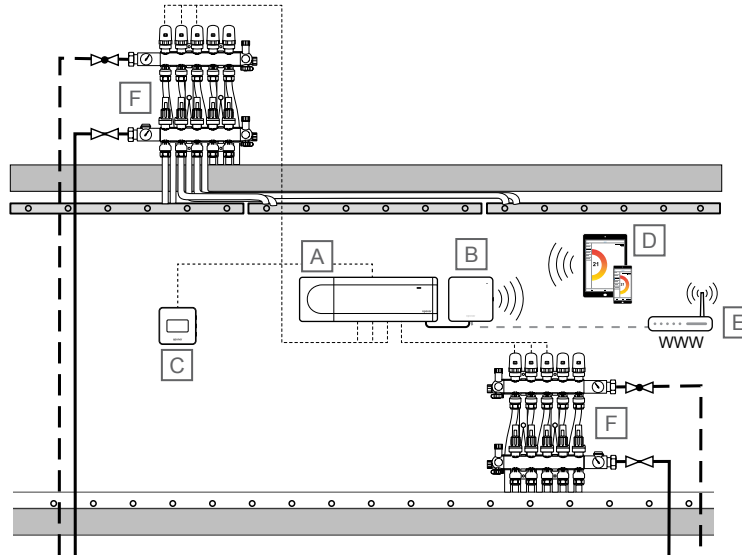

SD0000049

Note

These are outline diagrams. Real systems must be installed according to applicable norms and regulations.

| Item | Description |
|------|--|
| A | Uponor Smatrix Base PULSE X-245 Room controller |
| B | Uponor Smatrix PULSE Com R-208 Communication module Connected to master room controller |
| C | Uponor Smatrix Base T-149 Digital thermostat with relative humidity sensor and operative sensor |
| D | Mobile device (smartphone, tablet, etc) |
| E | Wi-Fi router |
| F | Manifold with actuator |

The wide array of connection possibilities presented with this communications protocol can be combined in any way best suited for the current system.

See *Cooling with high protection to avoid condensation, Page 3* and *Cooling function, Page 6* for more information about setting up the system for cooling in the Uponor Smatrix Pulse app.

Room temperature control

This application example shows underfloor heating with ceiling cooling (4-pipe).

The room temperature is controlled by a single Uponor Smatrix Base Pulse room controller and thermostat. The room controller regulate room temperature by operating the actuators on two underfloor manifolds (one for underfloor heating, and one for ceiling cooling).

The system is based on a bus communications protocol (requires the thermostats unique ID to be registered to the controller), utilising daisy chain, direct or star topology connections. This allows serial and parallel connections, making wiring and connection of thermostats and system devices much easier than connecting one thermostat per connection terminal.

10 Application examples – Move

10.1 Supply water temperature control, heating

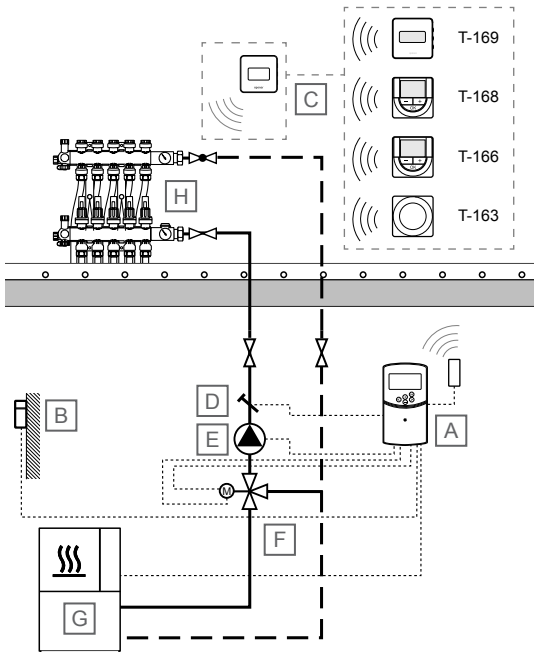

SD0000050

Note

These are outline diagrams. Real systems must be installed according to applicable norms and regulations.

| Item | Description |
|------|---|
| A | Uponor Smatrix Move X-157 Supply temperature controller, with optional antenna (required if using room thermostat) |
| B | Outdoor temperature sensor |
| C | Wireless room thermostat for supply temperature calculation <ul style="list-style-type: none"> • Uponor Smatrix Wave T-163 Public thermostat • Uponor Smatrix Wave T-166 Digital thermostat • Uponor Smatrix Wave T-168 Programmable digital thermostat with relative humidity sensor • Uponor Smatrix Wave T-169 Digital thermostat with relative humidity sensor and operative sensor |
| D | Supply temperature sensor |
| E | Circulation pump |
| F | 3 way mixing valve with 230 V 3-point actuator |
| G | Heat source |
| H | Manifold with actuator |

The supply temperature is regulated using a supply temperature controller (Uponor Smatrix Move) with outdoor temperature sensor and heating curve.

Connected to the supply temperature controller is the heat source, circulation pump, supply temperature sensor, and 3 way mixing valve.

With an external antenna Uponor Smatrix Move can use different types of thermostats to regulate heating and cooling in the system. Designed for maximum comfort, the thermostats communicate with

the controller by radio link. It is possible to mix a maximum of two different types of Uponor Smatrix Wave thermostats in the same installation. One of these thermostats though can only function as a wireless connection point for the outdoor temperature sensor.

10.2 Supply water temperature control, heating/cooling

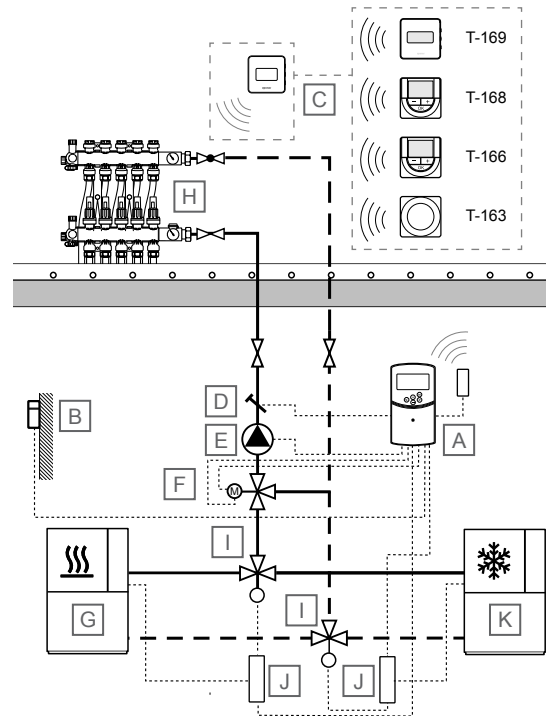

SD0000051

Note

These are outline diagrams. Real systems must be installed according to applicable norms and regulations.

| Item | Description |
|------|---|
| A | Uponor Smatrix Move X-157 Supply temperature controller, with optional antenna (required if using room thermostat) |
| B | Outdoor temperature sensor |
| C | Wireless room thermostat for supply temperature calculation <ul style="list-style-type: none"> • Uponor Smatrix Wave T-163 Public thermostat • Uponor Smatrix Wave T-166 Digital thermostat • Uponor Smatrix Wave T-168 Programmable digital thermostat with relative humidity sensor • Uponor Smatrix Wave T-169 Digital thermostat with relative humidity sensor and operative sensor |
| D | Supply temperature sensor |
| E | Circulation pump |
| F | 3 way mixing valve with 230 V 3-point actuator |
| G | Heat source |
| H | Manifold with actuator |
| I | Heating/cooling switchover valve with 230 V actuator |

| Item | Description |
|------|------------------------------|
| J | Heating/cooling relay, 230 V |
| K | Chiller |

The supply temperature is regulated using a supply temperature controller (Uponor Smatrix Move) with outdoor temperature sensor and heating/cooling curves.

Connected to the supply temperature controller is the heat source (via heating/cooling relay), chiller (via heating/cooling relay), circulation pump, supply temperature sensor, 3 way mixing valve, and heating/cooling switchover valve.

With an external antenna Uponor Smatrix Move can use different types of thermostats to regulate heating and cooling in the system. Designed for maximum comfort, the thermostats communicate with the controller by radio link. It is possible to mix a maximum of two different types of Uponor Smatrix Wave thermostats in the same installation. One of these thermostats though can only function as a wireless connection point for the outdoor temperature sensor.

11 Application examples – Move PRO

11.1 Industrial/Retail with offices and Snow melt - KNX

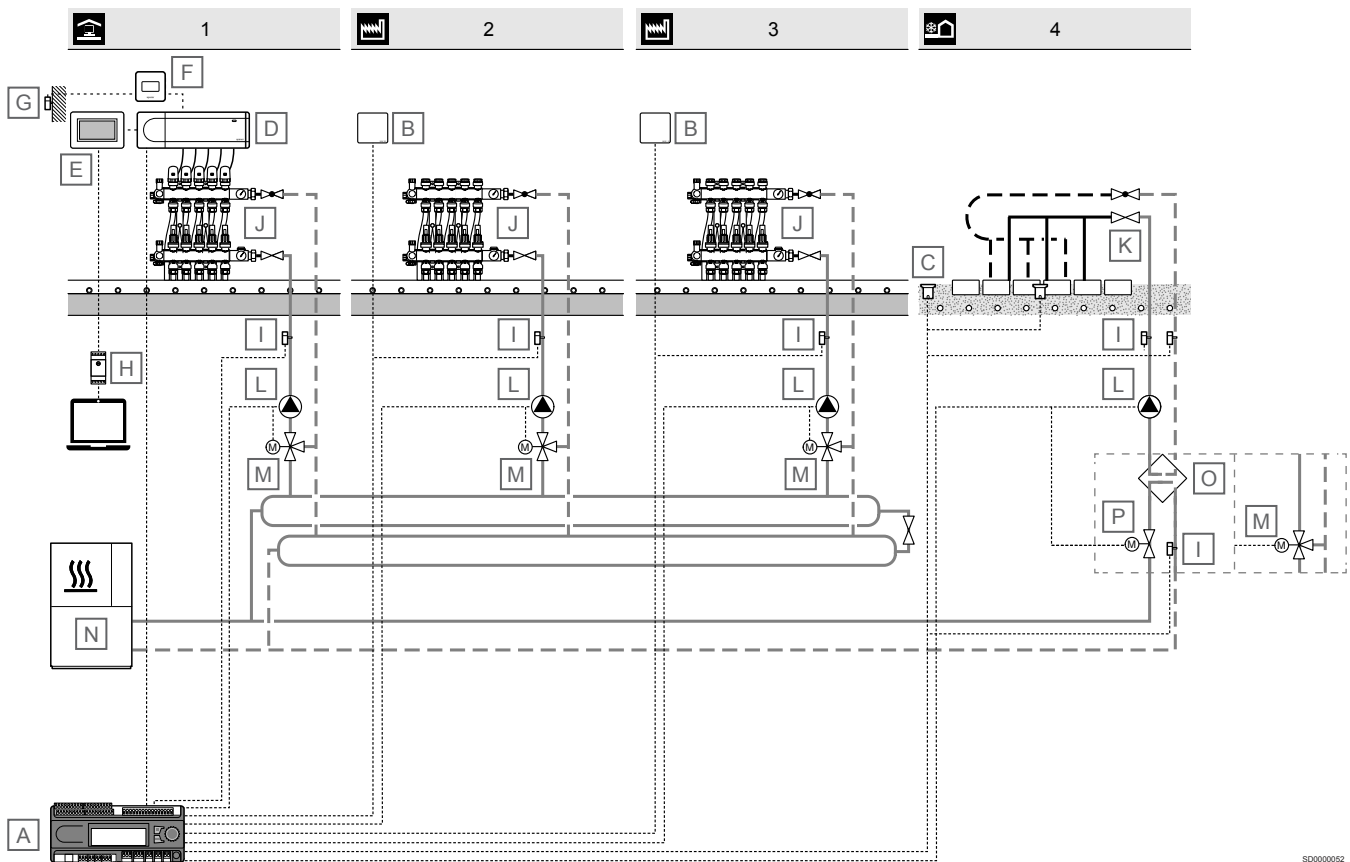

SD000052

Note

These are outline diagrams. Real systems must be installed according to applicable norms and regulations.

| Item | Description |
|------|--|
| A | Uponor Smatrix Move PRO X-159 Supply temperature controller, with heating application |
| B | Uponor Smatrix Move PRO S-155 Room sensor |
| C | Uponor Smatrix Move PRO S-158 Snow sensor |
| D | Uponor Smatrix Base PRO X-147 Room controller |
| E | Uponor Smatrix Base PRO I-147 Touch screen interface |
| F | Uponor Smatrix Base T-149 Digital room thermostat |
| G | Uponor Smatrix S-1XX Outdoor temperature sensor |
| H | Uponor Smatrix Base PRO R-147 KNX KNX module |
| I | Uponor Smatrix Move S-152 Supply/return temperature sensor |

| Item | Description |
|------|--|
| J | Manifold with actuator |
| K | Tichelmann Manifold/Manifold with actuator |
| L | Circulation pump |
| M | 3 way mixing valve with 0-10 V actuator |
| N | Heat source |
| O | Heat exchanger |
| P | Valve with 0-10 V actuator |

This application example shows an Uponor Smatrix Move PRO supply temperature controller (with the heating application installed) in an industrial/retail setting with offices and Snow melt. The system is connected to a BMS via a KNX connected Uponor Smatrix Base PRO room controller (requires the Uponor Smatrix Base PRO R-147 KNX-module).

Zone 1 is controlling the supply temperature to the offices, where an Uponor Smatrix Base PRO system is regulating the room temperature via underfloor loops.

Zone 2 and 3 is controlling the supply temperature to the industrial/retail spaces, using a room temperature sensor to regulate the room temperature via underfloor loops from the Move PRO supply temperature controller.

Zone 4 is controlling the supply temperature to the snow melt (Meltaway function) area, it regulates the meltaway loops using supply and return line sensors and snow sensors.

Zone 1

If the zone is setup as **Smatrix Base PRO** in the Uponor Smatrix Move PRO supply temperature controller, individual room control in the zone is enabled via an integrated Uponor Smatrix Base PRO system. The supply temperature setpoint is calculated using sensor data and current mode from the Base PRO system.

The outdoor temperature sensor is connected to the Base PRO system via a thermostat, registered as a system device. The thermostat is preferably placed in a non-public area such as a technical room. The outdoor temperature sensor data will also be used by the other zones.

This requires the Move PRO controller to be connected to a Smatrix Base PRO bus.

Zone 2 and 3

If the zone is setup as **Stand Alone Control** in the Uponor Smatrix Move PRO supply temperature controller, the controller operates without individual room control. The supply temperature setpoint is calculated using an outdoor sensor and an optional room temperature sensor.

The optional room temperature sensor is placed in a reference area and enables an indoor temperature setpoint parameter. It is used to

keep the indoor temperature as close as possible to the indoor temperature setpoint.

Zone 4

If the zone is setup as **Meltaway** (snow melt) in the Uponor Smatrix Move PRO supply temperature controller, snow melting (keeping large areas clear of snow) is enabled in the zone. The supply temperature setpoint is calculated using an outdoor sensor, a ground temperature sensor, and a ground moisture sensor.

When to start or stop snow melting (status: Stop, Idle or Meltaway) is determined by using an outdoor temperature sensor and two Uponor Smatrix Move PRO Sensor Snow S-158 sensors. One of S-158 sensors is used for measuring the ground temperature and the other one is used for measuring the ground moisture level.

The return temperature sensor is used to calculate the difference between the supply and return temperature and trips an alarm if the difference is too high.

The primary return sensor is used to protect the heat source from too low return temperatures.

11.2 Industrial/Retail and Snow melt - Modbus

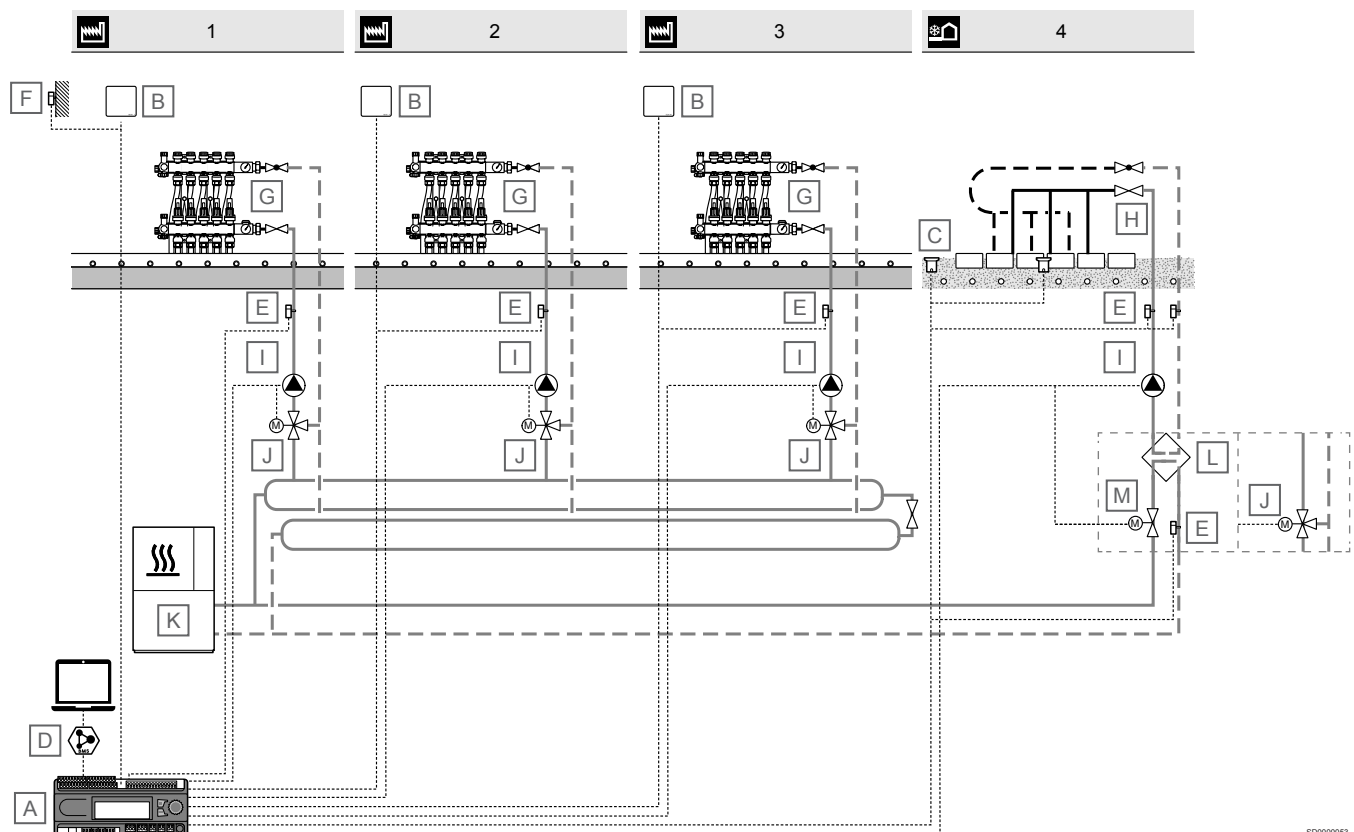

SD000053

| Note | |
|---|--|
| These are outline diagrams. Real systems must be installed according to applicable norms and regulations. | |
| Item | Description |
| A | Uponor Smatrix Move PRO X-159 Supply temperature controller, with heating application |
| B | Uponor Smatrix Move PRO S-155 |

| Item | Description |
|------|---|
| | Room sensor |
| C | Uponor Smatrix Move PRO S-158 Snow sensor |
| D | BMS connection |
| E | Uponor Smatrix Move S-152 Supply/return temperature sensor |

| Item | Description |
|------|--|
| F | Uponor Smatrix S-1XX Outdoor temperature sensor |
| G | Manifold with actuator |
| H | Tichelmann Manifold/Manifold with actuator |
| I | Circulation pump |
| J | 3 way mixing valve with 0-10 V actuator |
| K | Heat source |
| L | Heat exchanger |
| M | Valve with 0-10 V actuator |

This application example shows an Uponor Smatrix Move PRO supply temperature controller (with the heating application installed) in an industrial/retail setting with offices and Snow melt. The system is connected to a BMS via Modbus (connected to the Uponor Smatrix Move PRO supply temperature controller).

Zones 1 through 3 is controlling the supply temperature to the industrial/retail spaces, using a room temperature sensor to regulate the room temperature via underfloor loops from the Move PRO supply temperature controller.

Zone 4 is controlling the supply temperature to the snow melt (Meltaway function) area, it regulates the meltaway loops using supply and return line sensors and snow sensors.

Zone 1 to 3

If the zone is setup as **Stand Alone Control** in the Uponor Smatrix Move PRO supply temperature controller, the controller operates

without individual room control. The supply temperature setpoint is calculated using an outdoor sensor and an optional room temperature sensor.

The optional room temperature sensor is placed in a reference area and enables an indoor temperature setpoint parameter. It is used to keep the indoor temperature as close as possible to the indoor temperature setpoint.

Zone 4

If the zone is setup as **Meltaway** (snow melt) in the Uponor Smatrix Move PRO supply temperature controller, snow melting (keeping large areas clear of snow) is enabled in the zone. The supply temperature setpoint is calculated using an outdoor sensor, a ground temperature sensor, and a ground moisture sensor.

When to start or stop snow melting (status: Stop, Idle or Meltaway) is determined by using an outdoor temperature sensor and two Uponor Smatrix Move PRO Sensor Snow S-158 sensors. One of S-158 sensors is used for measuring the ground temperature and the other one is used for measuring the ground moisture level.

The return temperature sensor is used to calculate the difference between the supply and return temperature and trips an alarm if the difference is too high.

The primary return sensor is used to protect the heat source from too low return temperatures.

11.3 Industrial/Retail with offices and Snow melt - Heating and Cooling

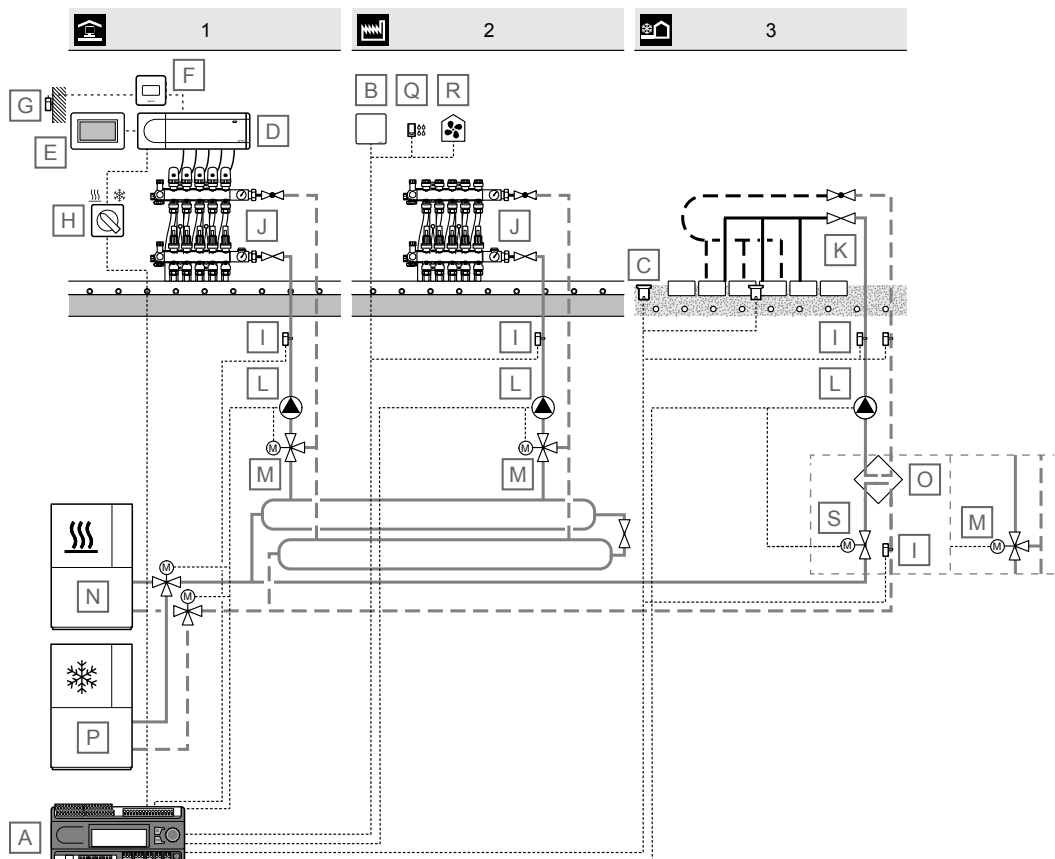

S0000054



Note

These are outline diagrams. Real systems must be installed according to applicable norms and regulations.

| Item | Description |
|------|---|
| A | Uponor Smatrix Move PRO X-159 Supply temperature controller, with with heating/cooling application |
| B | Uponor Smatrix Move PRO S-155 Room sensor |
| C | Uponor Smatrix Move PRO S-158 Snow sensor |
| D | Uponor Smatrix Base PRO X-147 Room controller |
| E | Uponor Smatrix Base PRO I-147 Touch screen interface |
| F | Uponor Smatrix Base T-149 Digital room thermostat |
| G | Uponor Smatrix S-1XX Outdoor temperature sensor |
| H | Heating/cooling switch |
| I | Uponor Smatrix Move S-152 Supply/return temperature sensor |
| J | Manifold with actuator |
| K | Tichelmann Manifold/Manifold with actuator |
| L | Circulation pump |
| M | 3 way mixing valve with 0-10 V actuator |
| N | Heat source |
| O | Heat exchanger |
| P | Chiller |
| Q | Uponor Smatrix Move PRO S-157 Humidity sensor |
| R | Dehumidifier |
| S | Valve with 0-10 V actuator |

This application example shows an Uponor Smatrix Move PRO supply temperature controller (with the heating/cooling application installed) in an industrial/retail setting with offices and Snow melt. Heating/cooling is delivered using a 2-pipe system.

Zone 1 is controlling the supply temperature to the offices, where an Uponor Smatrix Base PRO system is regulating the room temperature via underfloor loops. A heating/cooling switch is connected to both the room controller and the supply temperature controller.

Zone 2 is controlling the supply temperature to the industrial/retail spaces, using a room temperature sensor to regulate the room

temperature via underfloor loops from the Move PRO supply temperature controller. A humidity sensor, and dehumidifier, is used to avoid condensation problems while in cooling mode.

Zone 3 is controlling the supply temperature to the snow melt (Meltaway function) area, it regulates the meltaway loops using supply and return line sensors and snow sensors. Meltaway cannot be active at the same time as cooling is produced to zones 1 and 2.

Zone 1

If the zone is setup as **Smatrix Base PRO** in the Uponor Smatrix Move PRO supply temperature controller, individual room control in the zone is enabled via an integrated Uponor Smatrix Base PRO system. The supply temperature setpoint is calculated using sensor data and current mode from the Base PRO system.

The outdoor temperature sensor is connected to the Base PRO system via a thermostat, registered as a system device. The thermostat is preferably placed in a non-public area such as a technical room. The outdoor temperature sensor data will also be used by the other zones.

This requires the Move PRO controller to be connected to a Smatrix Base PRO bus.

Zone 2

If the zone is setup as **Stand Alone Control** in the Uponor Smatrix Move PRO supply temperature controller, the controller operates without individual room control. The supply temperature setpoint is calculated using an outdoor sensor and an optional room temperature sensor.

The optional room temperature sensor is placed in a reference area and enables an indoor temperature setpoint parameter. It is used to keep the indoor temperature as close as possible to the indoor temperature setpoint.

Zone 3

If the zone is setup as **Meltaway** (snow melt) in the Uponor Smatrix Move PRO supply temperature controller, snow melting (keeping large areas clear of snow) is enabled in the zone. The supply temperature setpoint is calculated using an outdoor sensor, a ground temperature sensor, and a ground moisture sensor.

When to start or stop snow melting (status: Stop, Idle or Meltaway) is determined by using an outdoor temperature sensor and two Uponor Smatrix Move PRO Sensor Snow S-158 sensors. One of S-158 sensors is used for measuring the ground temperature and the other one is used for measuring the ground moisture level.

The return temperature sensor is used to calculate the difference between the supply and return temperature and trips an alarm if the difference is too high.

The primary return sensor is used to protect the heat source from too low return temperatures.

11.4 Industrial/Retail with offices and Snow melt

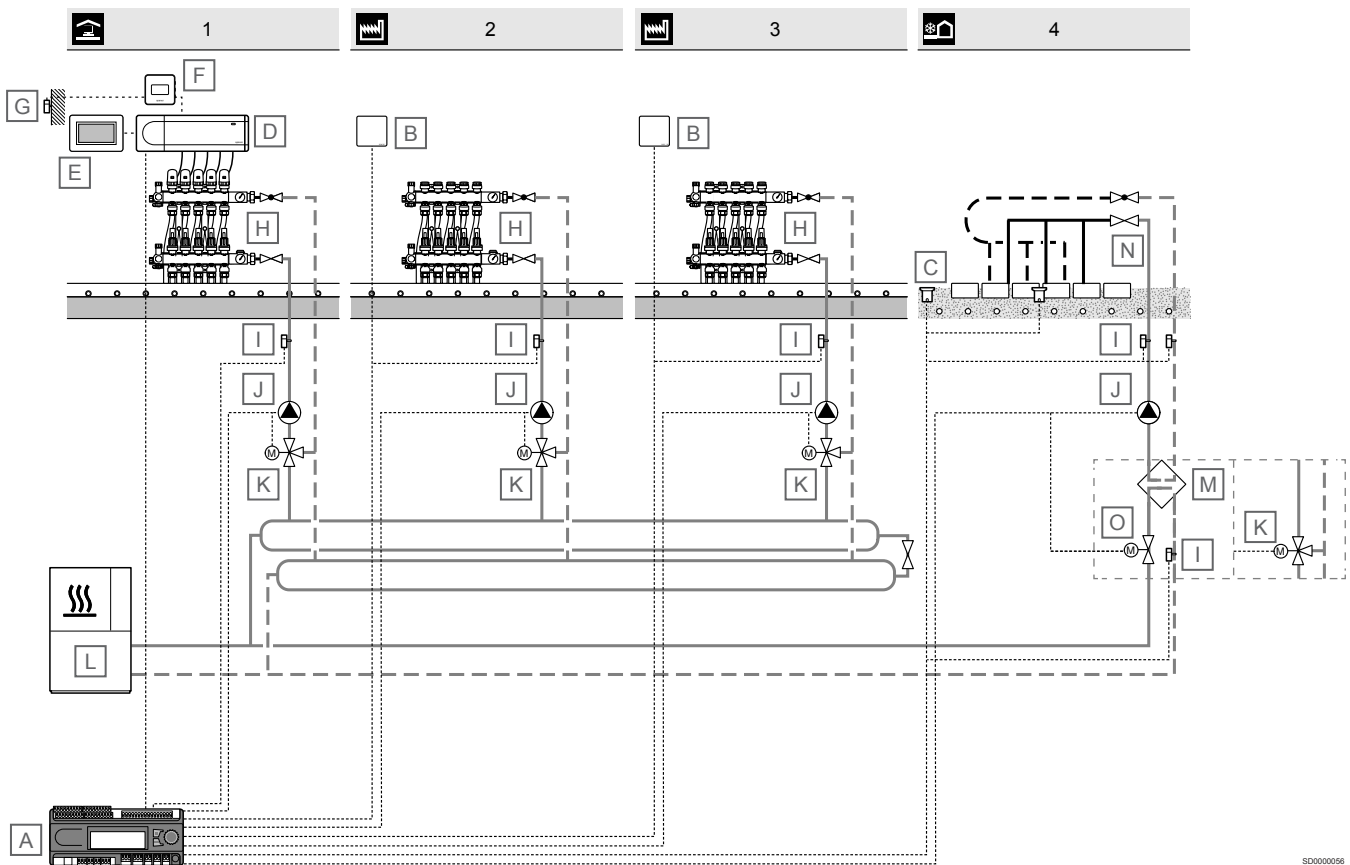

S0000056

Note

These are outline diagrams. Real systems must be installed according to applicable norms and regulations.

| Item | Description |
|------|--|
| A | Uponor Smatrix Move PRO X-159 Supply temperature controller, with heating application |
| B | Uponor Smatrix Move PRO S-155 Room sensor |
| C | Uponor Smatrix Move PRO S-158 Snow sensor |
| D | Uponor Smatrix Base PRO X-147 Room controller |
| E | Uponor Smatrix Base PRO I-147 Touch screen interface |
| F | Uponor Smatrix Base T-149 Digital room thermostat |
| G | Uponor Smatrix S-1XX Outdoor temperature sensor |
| H | Manifold with actuator |
| I | Uponor Smatrix Move S-152 Supply/return temperature sensor |
| J | Circulation pump |
| K | 3 way mixing valve with 0-10 V actuator |
| L | Heat source |
| M | Heat exchanger |

| Item | Description |
|------|--|
| N | Tichelmann Manifold/Manifold with actuator |
| O | Valve with 0-10 V actuator |

This application example shows an Uponor Smatrix Move PRO supply temperature controller (with the heating application installed) in an industrial/retail setting with offices and Snow melt.

Zone 1 is controlling the supply temperature to the offices, where an Uponor Smatrix Base PRO system is regulating the room temperature via underfloor loops.

Zone 2 and 3 is controlling the supply temperature to the industrial/retail spaces, using a room temperature sensor to regulate the room temperature via underfloor loops from the Move PRO supply temperature controller.

Zone 4 is controlling the supply temperature to the snow melt (Meltaway function) area, it regulates the meltaway loops using supply and return line sensors and snow sensors.

Zone 1

If the zone is setup as **Smatrix Base PRO** in the Uponor Smatrix Move PRO supply temperature controller, individual room control in the zone is enabled via an integrated Uponor Smatrix Base PRO system. The supply temperature setpoint is calculated using sensor data and current mode from the Base PRO system.

The outdoor temperature sensor is connected to the Base PRO system via a thermostat, registered as a system device. The thermostat is preferably placed in a non-public area such as a technical room. The outdoor temperature sensor data will also be used by the other zones.

This requires the Move PRO controller to be connected to a Smatrix Base PRO bus.

Zone 2 and 3

If the zone is setup as **Stand Alone Control** in the Uponor Smatrix Move PRO supply temperature controller, the controller operates without individual room control. The supply temperature setpoint is calculated using an outdoor sensor and an optional room temperature sensor.

The optional room temperature sensor is placed in a reference area and enables an indoor temperature setpoint parameter. It is used to keep the indoor temperature as close as possible to the indoor temperature setpoint.

Zone 4

If the zone is setup as **Meltaway** (snow melt) in the Uponor Smatrix Move PRO supply temperature controller, snow melting (keeping large areas clear of snow) is enabled in the zone. The supply temperature setpoint is calculated using an outdoor sensor, a ground temperature sensor, and a ground moisture sensor.

When to start or stop snow melting (status: Stop, Idle or Meltaway) is determined by using an outdoor temperature sensor and two Uponor Smatrix Move PRO Sensor Snow S-158 sensors. One of S-158 sensors is used for measuring the ground temperature and the other one is used for measuring the ground moisture level.

The return temperature sensor is used to calculate the difference between the supply and return temperature and trips an alarm if the difference is too high.

The primary return sensor is used to protect the heat source from too low return temperatures.

| Item | Description |
|------|---|
| C | Uponor Smatrix Move S-152 Supply/return temperature sensor |
| D | Uponor Smatrix S-1XX Outdoor temperature sensor |
| E | Tichelmann Manifold/Manifold with actuator |
| F | Circulation pump |
| G | 3 way mixing valve with 0-10 V actuator |
| H | Heat exchanger |
| I | Heat source |
| J | Valve with 0-10 V actuator |

This application example shows an Uponor Smatrix Move PRO supply temperature controller (with the heating or heating/cooling application installed) in a Snow melt setup (Meltaway function).

Zone 3 is controlling the supply temperature to the snow melt (Meltaway function) area, it regulates the meltaway loops using supply and return line sensors and snow sensors.

Zone 3

If the zone is setup as **Meltaway** (snow melt) in the Uponor Smatrix Move PRO supply temperature controller, snow melting (keeping large areas clear of snow) is enabled in the zone. The supply temperature setpoint is calculated using an outdoor sensor, a ground temperature sensor, and a ground moisture sensor.

When to start or stop snow melting (status: Stop, Idle or Meltaway) is determined by using an outdoor temperature sensor and two Uponor Smatrix Move PRO Sensor Snow S-158 sensors. One of S-158 sensors is used for measuring the ground temperature and the other one is used for measuring the ground moisture level.

The return temperature sensor is used to calculate the difference between the supply and return temperature and trips an alarm if the difference is too high.

The primary return sensor is used to protect the heat source from too low return temperatures.

11.5 Snow melt

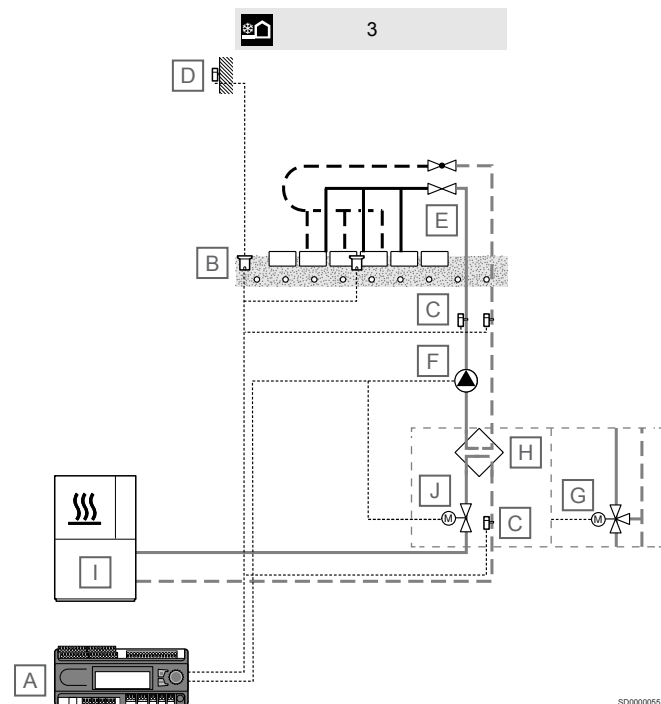

Note

These are outline diagrams. Real systems must be installed according to applicable norms and regulations.

| Item | Description |
|------|---|
| A | Uponor Smatrix Move PRO X-159 Supply temperature controller, with with heating application |
| B | Uponor Smatrix Move PRO S-158 Snow sensor |

Uponor

Uponor Corporation

Äyritie 20
01510 Vantaa, Finland

1116265 v3_02_2020_EN
Production: Uponor/MRY

Uponor reserves the right to make changes, without prior notification, to the specification of incorporated components in line with its policy of continuous improvement and development.



www.uponor.com