



**E901** | Programmable, wired thermostat

**FULL MANUAL**

# TABLE OF CONTENTS

<b>1. Introduction</b>	<b>3</b>
1.1 Product Compliance	3
1.2 Safety Informations	3
<b>2. Product Overview</b>	<b>4</b>
2.1 Package content	5
2.2 Proper thermostat location	5
2.3 Wall mounting	6
<b>3. Connection description</b>	<b>7</b>
<b>4. Before you start (first power on)</b>	<b>8</b>
4.1 LCD icon description	9
4.2 Button description	9
<b>5. Time settings</b>	<b>10</b>
<b>6. Operation</b>	<b>11</b>
6.1 Manual mode	11
6.1.1 Comfort mode	11
6.1.2 Economic mode	12
6.2 AUTO mode - two schedule types	13
6.2.1 First type schedule	13
6.2.2 Second type schedule	13
6.2.3 Switching between schedules (AUTO Mode) type 1 and 2	14
6.3 First type schedule programming	15
6.3.1 Default program settings (1-3)	15
6.3.2 Choosing and programming user programs (4-9)	16
6.3.3 Frost Protection program setting	18
6.3.4 Temporary override mode	19
6.4 Second type schedule programming	20
6.4.1 Temporary override mode	21
6.5 Party mode	22
6.6 Holiday mode	23
6.7 Key lock function	24
<b>7. Installer settings</b>	<b>25</b>
<b>8. Thermostat's reboot</b>	<b>27</b>
<b>9. Clear settings - factory reset</b>	<b>27</b>
<b>10. Cleaning and Maintenance</b>	<b>28</b>
<b>11. Technical Informations</b>	<b>28</b>
<b>12. Warranty</b>	<b>29</b>

# 1. Introduction

## 1.1 Product Compliance

This product complies with the essential requirements and other relevant provisions of Directives 2014/53/EU and 2011/65/EU.

## 1.2 Safety Informations

- Before starting installation work and before using the product, read the entire manual.
- The information contained in the instructions is essential for proper functioning.
- To avoid accidents resulting in personal injury and material damage, please follow all safety precautions, specified in this manual.
- The device should not be used by people with limited mental, sensory or mental abilities, without experience, of insufficient knowledge as well as children.
- Do not use an unassembled device (eg without a cover).
- The device may only be opened by a qualified person.
- Keep electrical devices out of the reach of children and ensure that they do not play with it. Children should not be left unattended. If necessary, disconnect the control system for the entire room.
- Do not leave the packaging, cabinet, or any loose parts of the device unattended, as they pose a risk to children.

### **WARNING!**

- Installation must be carried out by a qualified person with appropriate electrical qualifications in accordance with standards and regulations in force in the given country and in the EU.
- Never try to connect the device other than as described in the manual.
- Before assembly, repair or maintenance as well as during any connection works it is absolutely necessary disconnect the mains supply and make sure that the terminals and electric wires are not live.
- The device may not be exposed to extreme temperatures, strong vibrations or subjected to mechanical shock.
- The device should not be used in unfavorable environmental conditions or in rooms where there is a concentration of flammable gases, fumes or dust.

### **WARNING!**

- There may be additional protection requirements for the entire installation that the installer is responsible for maintaining.



Care for the natural environment is of paramount importance to us. The awareness that we manufacture electronic devices obliges us to dispose of used electronic components and devices safely. Therefore the company has received a registration number issued by the Chief Inspector for Environmental Protection. The crossed out symbol the trash can on the product means that the product must not be disposed of with ordinary waste containers. Sorting waste for recycling helps to protect the environment. It is the user's responsibility to surrender used equipment to a designated collection point for recycling waste from electrical and electronic equipment.

## 2. Product Overview

E901 is a programmable, surface-mounted electronic room thermostat, used for wireless control of heating devices (e.g. gas, oil boilers, heat pumps) or cooling devices. It has the function of creating your own schedules. Thanks to the built-in algorithms, it offers much better temperature control accuracy than traditional mechanical thermostats. Please read these instructions carefully before using the device for the first time. The thermostat should use 2xAA, 1.5V alkaline batteries. Rechargeable batteries are not allowed.

### Product features:

- has 2 types of time schedules
- possibility to choose hysteresis or built-in TPI algorithm
- maximum / minimum temperature limitation
- two relay types (selectable in thermostat settings): NO (normally open) or NC (normally closed)
- has the HEATING / COOLING modes
- PIN lock

## 2.1 Package content

- 1) E901 thermostat
- 2) Quick Guide
- 3) 2xAA batteries
- 4) Mounting screws

1



E901 thermostat

2



Quick Guide

3



2xAA batteries

4



Mounting screws

## 2.2 Proper thermostat location

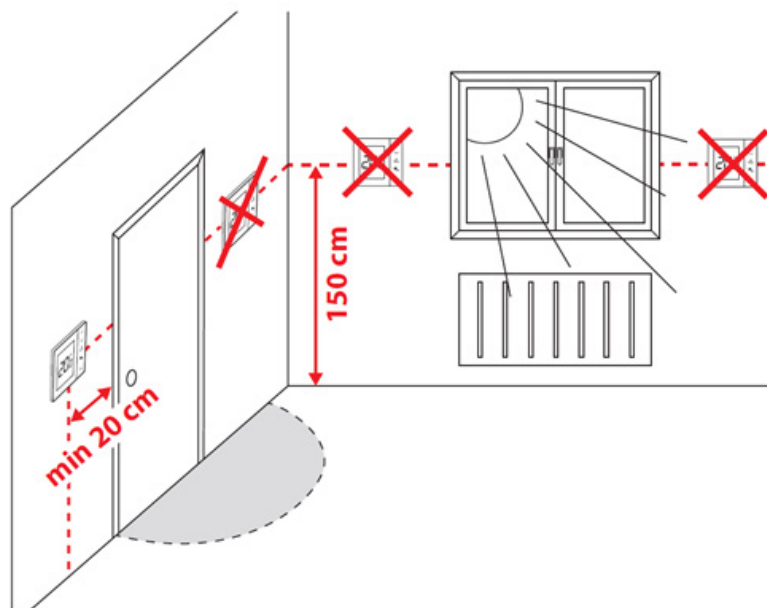

**Please note:**

**The ideal position to thermostat mounting is about 1,5m under floor level far from heating or cooling sources. Thermostat can't be exposed to sunlight or any extreme conditions like for example draft.**

Because of fire and explosion risk there is not allowed to use thermostat in atmosphere of explosive gases and flammable liquids (eg coal dust). In case if any of listed dangers occur you have to use additional protection measures – anti-dust and explosive gases (tight cover) or prevent their formation. Furthermore, thermostat can't be used in condensation of water vapor conditions and be exposed to water action.

## 2.3 Wall mounting



Remove the thermostat cover as shown in the picture. If there are batteries inside, remove them.



Use a screwdriver to push the plastic tabs in as shown in the figure until you feel resistance, and tilt the front part of the housing.



Separate the front part from the back part in the direction shown above.



Then fix the back cover to the wall using the supplied mounting screws and the holes provided (see bigger arrows). Connect the wires to the COM / NO connector (see smaller arrows).



Using the hinges, fold the back and front covers by moving as shown in the picture above.

### 3. Connection description

a) Connection diagram to gas boiler

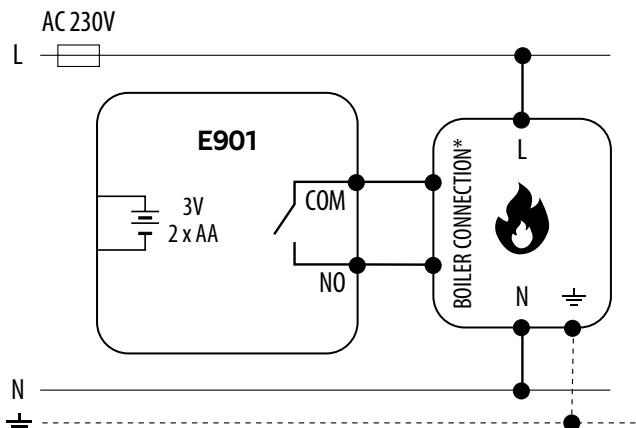

b) Connection diagram to the pump / actuator

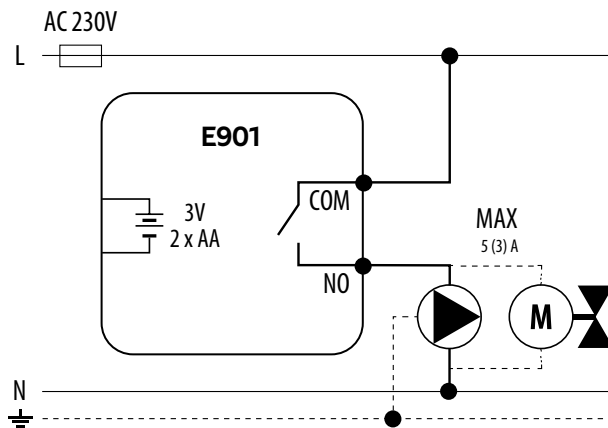

c) Connection diagram to the control box

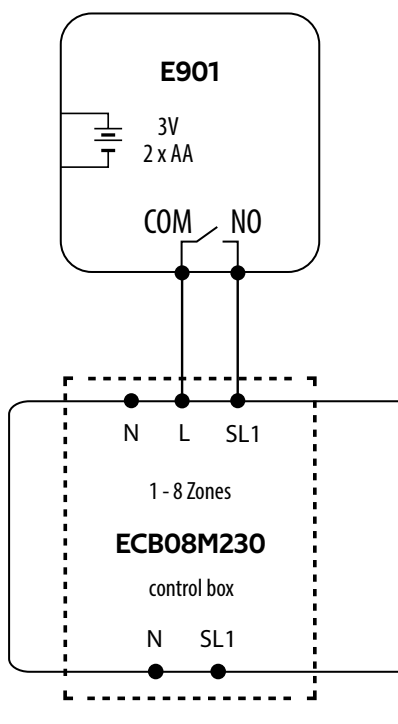

#### Legend:



**Boiler - Boiler connection\***  
- Boiler's contacts for ON/OFF thermostat (according to the boiler's instructions)



Pump



Valve actuator

#### Symbols explanation:

**L, N** - power supply 230V

**COM, NO** - voltage-free output

- fuse

- batteries

#### 4. Before you start (first power on)

The thermostat is powered by two 1.5V AA alkaline batteries. Insert the batteries into the compartment under the front housing, paying attention to their polarity. The thermostat will start up showing the current software version and then go to the main screen.

1

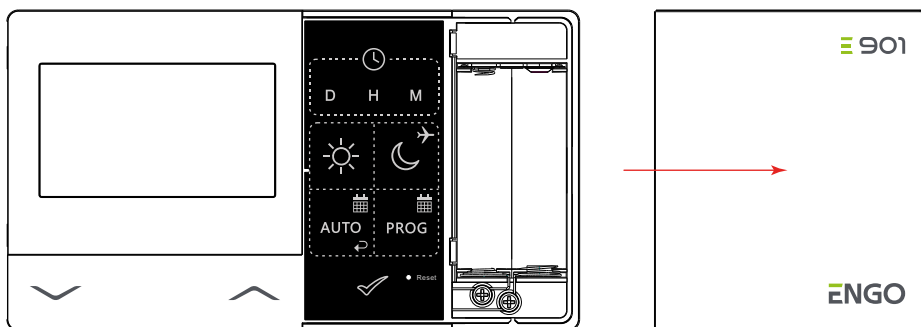

PULL OFF THERMOSTAT SLIDE COVER.

2

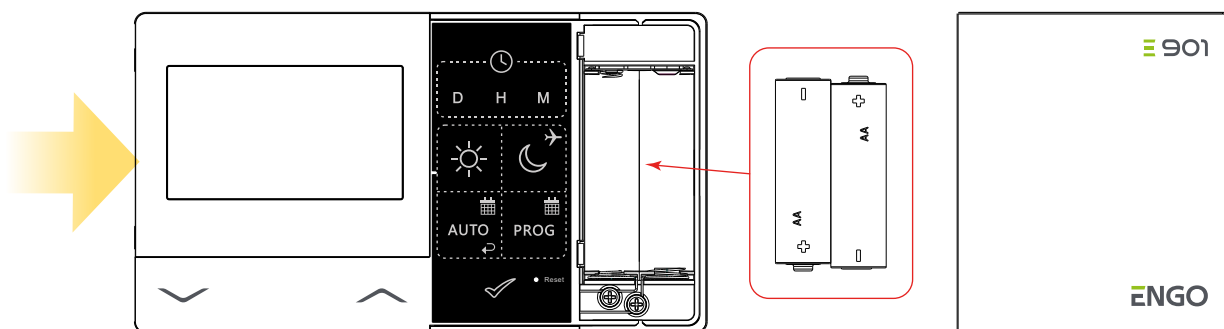

INSERT THE BATTERIES, PAYING ATTENTION TO THEIR POLARITY!

3

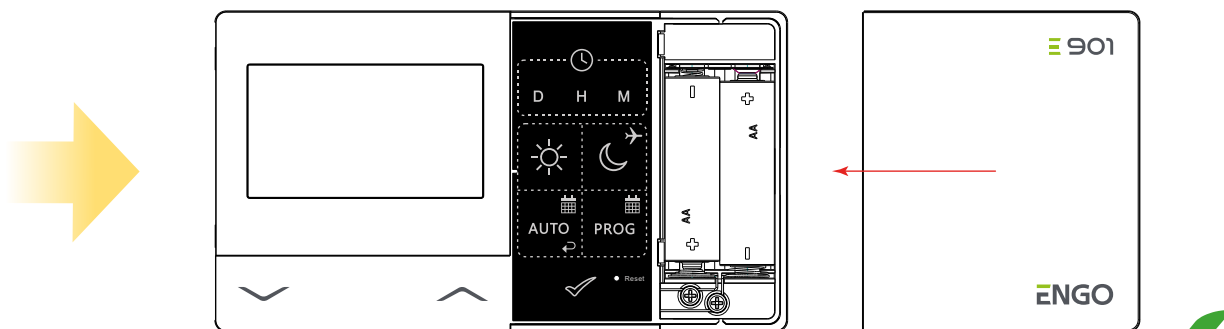

PLACE AND SLIDE THERMOSTAT FRONT HOUSING.  
THE LCD WILL TURN ON WHEN THE BATTERIES ARE INSERTED.



## 4.1 LCD icon description

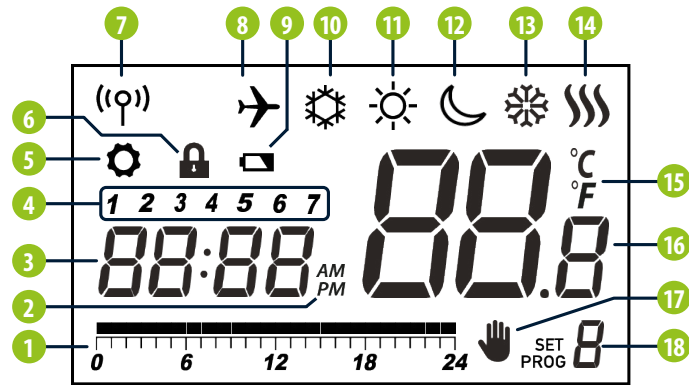

- |   |                                 |
|---|---------------------------------|
| 1. Program timeline indicator           | 10. Frost Protection Mode       |
| 2. AM/PM                                | 11. Comfort Mode                |
| 3. Clock                                | 12. Economic Mode               |
| 4. Day of the week indicator            | 13. Cooling status              |
| 5. Settings icon                        | 14. Heating status              |
| 6. Key lock function                    | 15. Temperature unit            |
| 7. Send a signal (pairing)* only E901RF | 16. Room / setpoint temperature |
| 8. Holiday Mode                         | 17. Temporary override          |
| 9. Low battery indicator                | 18. Program number              |

## 4.2 Button description

Button	Function
∨	Change the parameter value down
∧	Change the parameter value up
D	Set the day of the week
H	Set the hour
M	Set the minutes
☀	Comfort temperature
☾→	Economic temperature / Holiday mode
AUTO 📅	AUTO mode / Back button
PROG 📅	Programming schedule / schedule type selection
✓	Confirm button
• Reset	Thermostat's reboot / Time reset

## 5. Time settings

Day/time settings are set using the D, H and M buttons. Please see steps below how to set time/day:

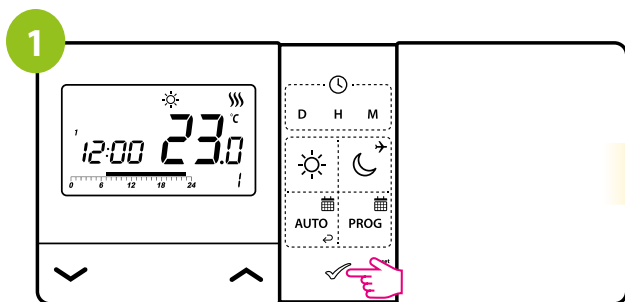

Press any button to highlight the display.

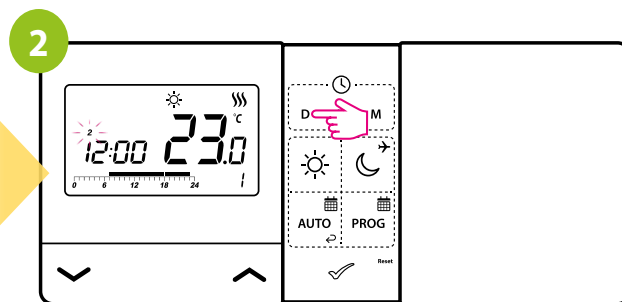

Pressing D button set the day.

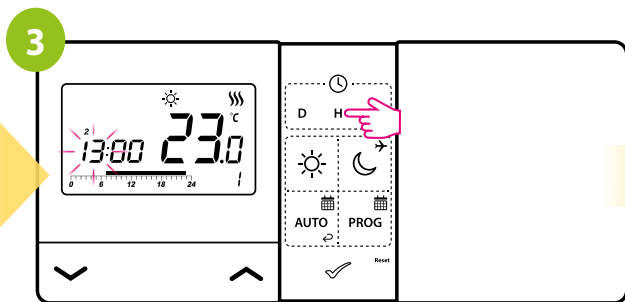

Pressing H button set the hour.

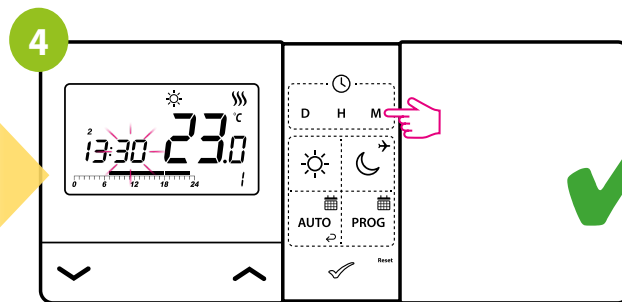

Pressing M button set the minutes.

## 6. Operation

### 6.1 Manual mode

There are two temperature setpoint levels at our disposal. In manual mode chosen setpoint temperature level is maintained permanently until user changes operation mode or set a different temperature for each level.

☀ - **Comfort Mode** - in this mode, the thermostat is to maintain a constant day temperature. When the temperature is set manually, e.g. 23°C, the thermostat maintains it until user switches to another operating mode or set a different temperature, e.g. 21°C.

🌙 - **Economic Mode** - in this mode, the thermostat is to maintain the reduced (night) temperature. When the temperature is set manually, e.g. 17°C, the thermostat maintains it until user switches to another mode or set a different temperature, e.g. 19°C.

#### 6.1.1 Comfort mode

In the comfort temperature mode, the thermostat is to maintain a constant day temperature. The comfort temperature level is indicated by sun icon. To set the comfort temperature, see the steps below:

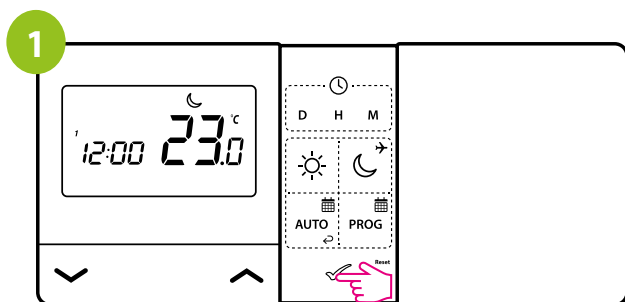

Press any button to highlight the display.

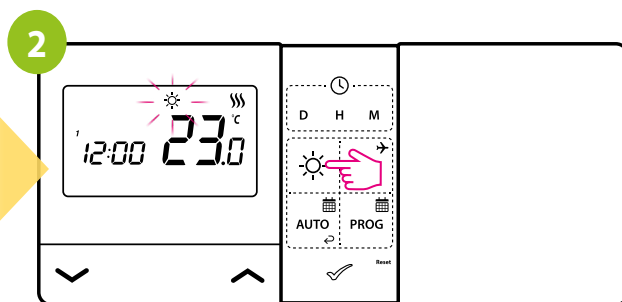

Press ☀ button to enter comfort temperature mode. The sun icon should be visible on the display.

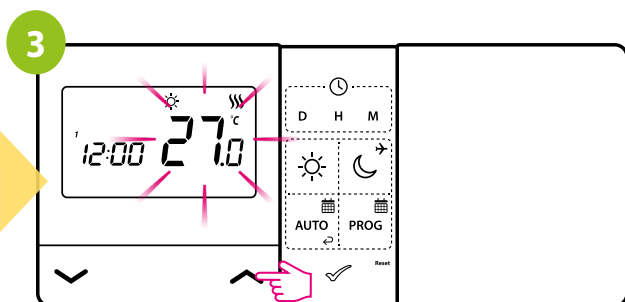

Using ^ or v buttons set new comfort temperature value.

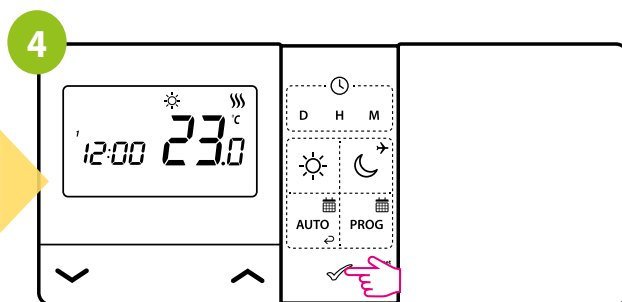

Confirm by ✓ button or wait until the thermostat will approve your choice itself and display the main screen.

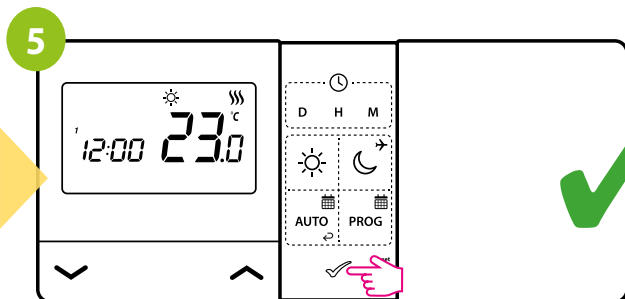

The thermostat will return to the main screen and display the actual room temperature.

## 6.1.2 Economic mode

In the economic temperature mode, the thermostat is to maintain a reduced (night) temperature. This is to ensure a more economical operation of the heating system when, for example, you are away from home. The economic temperature level is indicated by the moon icon. To set the economic (night) temperature, see the steps below:

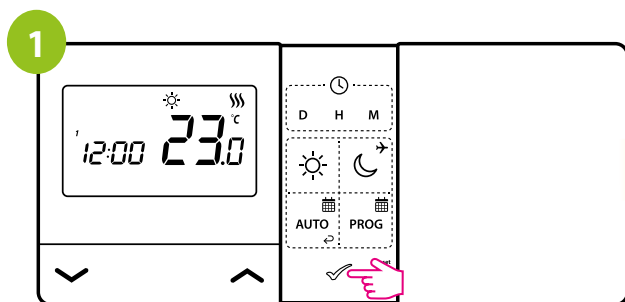

Press any button to highlight the display.

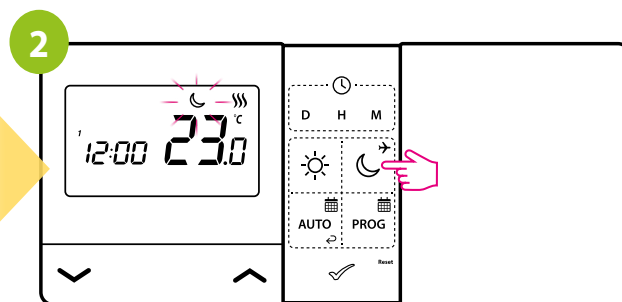

Press ☾ button to enter economic temperature mode.  
The moon icon should be visible on the display.

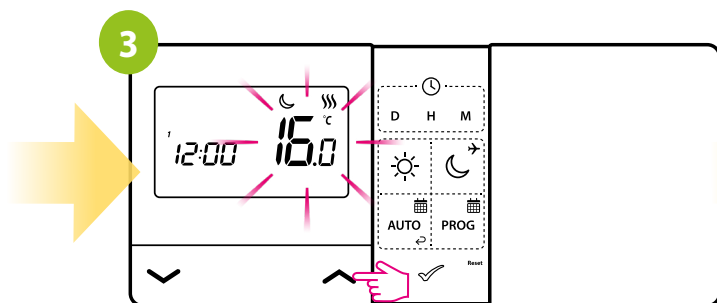

Using  $\wedge$  or  $\vee$  buttons set new economic temperature value.

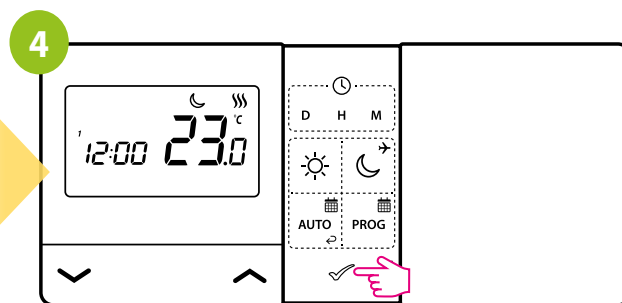

Confirm by  $\checkmark$  button or wait until the thermostat will approve your choice itself and display the main screen.

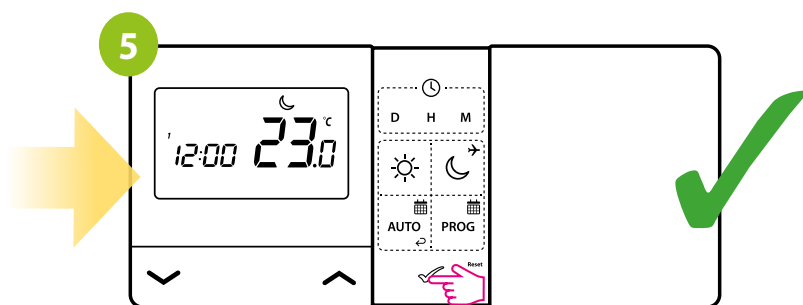

The thermostat will return to the main screen and display the actual room temperature.

## 6.2 AUTO mode - two schedule types

 - **AUTO Mode** - In the automatic mode, the thermostat maintains the set temperature according to the schedule selected by the user. You can choose from 2 types of schedule to manage the temperature during the week.

### 6.2.1 First type schedule

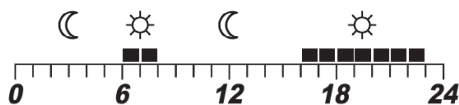

First type schedule mode is represented by timeline - 24 hours of a day. Empty „boxes” means hours where Economic (Moon) setpoint temperature will be maintained, black „boxes” means hours where Comfort (Sun) setpoint temperature will be maintained.

There are three different configurations in a schedule type 1:

- Two different programs (timelines), separate program for working days (Monday to Friday) and separate program for weekends (Saturday to Sunday)
- Individual programs (timelines) for each day of the week
- Same program (timeline) for the whole week

### 6.2.2 Second type schedule

Schedule type 2 enables the programming of 6 time intervals per day, with precision up to 10 minutes. Each of the 6 time intervals allows you to set a different temperature (schedule type 1 is limited to switching between two setpoint temperatures (SUN/MOON) at full hours time periods).

When creating a schedule type 2, you must define time and temperature setpoint (thermostat will start to maintain given setpoint temperature from given time setting). There are three different schedule configurations:

- Two different programs, separate program for working days (Monday to Friday) and separate program for weekends (Saturday to Sunday)
- Individual programs for each day of the week
- Same program for the whole week

### Schedule of the second type example

TIME INTERVAL	DAYS OF THE WEEK (1 TO 5) MON-FRI	DAYS OF THE WEEK (6 TO 7) SAT-SUN
P1	Time 6:00 Temp. setpoint 21°C	Time 6:00 Temp. setpoint 18°C
P2	Time 8:00 Temp. setpoint 14°C	Time 8:00 Temp. setpoint 20°C
P3	Time 11:00 Temp. setpoint 21°C	Time 11:00 Temp. setpoint 22°C
P4	Time 13:00 Temp. setpoint 14°C	Time 13:00 Temp. setpoint 20°C
P5	Time 16:00 Temp. setpoint 21°C	Time 16:00 Temp. setpoint 18°C
P6	Time 21:00 Temp. setpoint 14°C	Time 21:00 Temp. setpoint 14°C

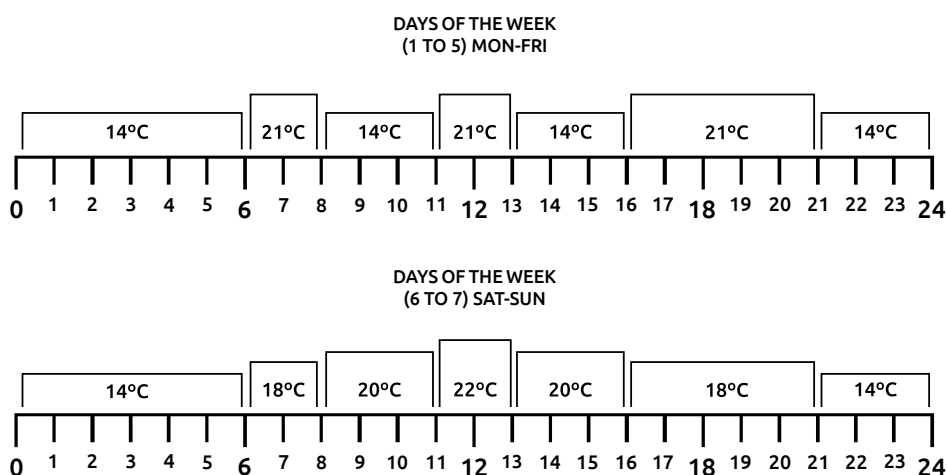

### 6.2.3 Switching between schedules (AUTO Mode) type 1 and 2

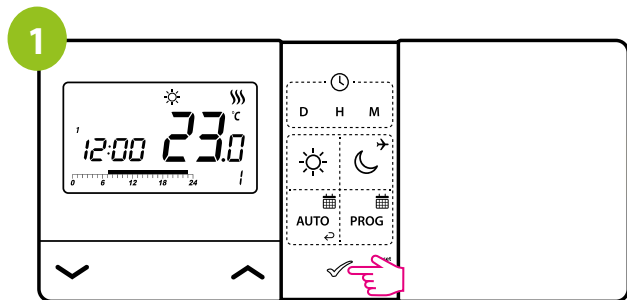

Press any button to highlight the display.

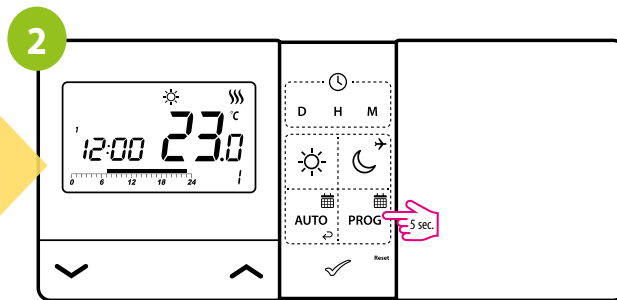

Press and hold **PROG** button for 5 seconds to enter to the schedule type selection.

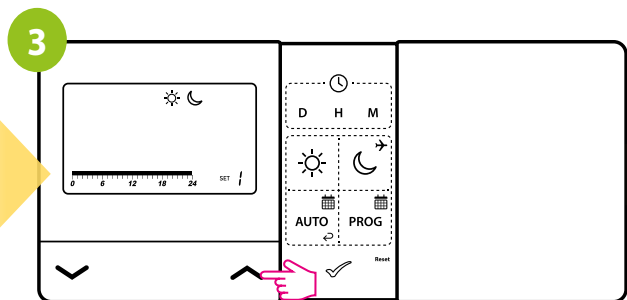

Using **^** or **v** buttons choose type of schedule.

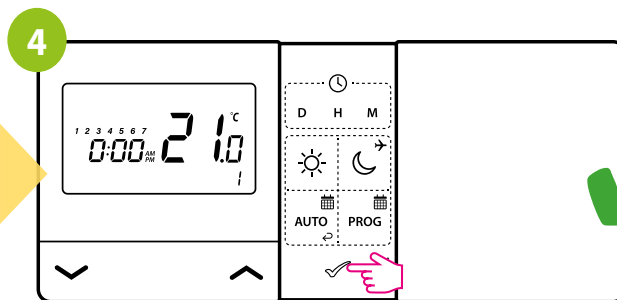

Confirm by **✓** button. Thermostat will return to the main screen saving chosen type of schedule (timeline will disappear if schedule type 2 is chosen).

## 6.3 First type schedule programming

### 6.3.1 Default program settings (1-3)

Within first type schedule mode there are 9 programs available. Programs 0 to 3 are factory-defined programs that cannot be changed. In this chapter you will find detailed information on the built-in factory programs (1-3) in the E901. These are pre-programmed time settings for the comfort and economy temperature that can be assigned to a selected day. To set up the program, see the steps below. The black squares on the timeline indicate the operating time for the comfort temperature mode, while the absence of them - for the economy temperature mode. Under the chart of each program, there is time (hour) when each mode is active. By default, program 1 is set for each day of the week.

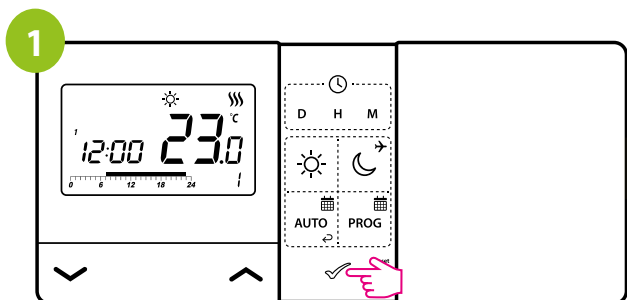

Press any button to highlight the display.

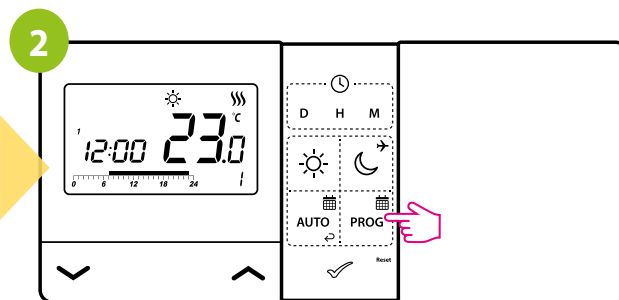

Press **PROG** button to enter the programming mode.

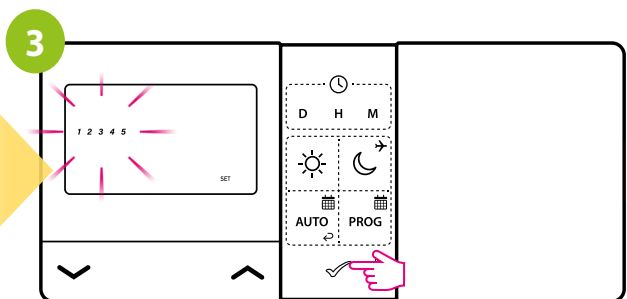

Select the week period using **^** or **v** buttons.  
Confirm by **✓** button.

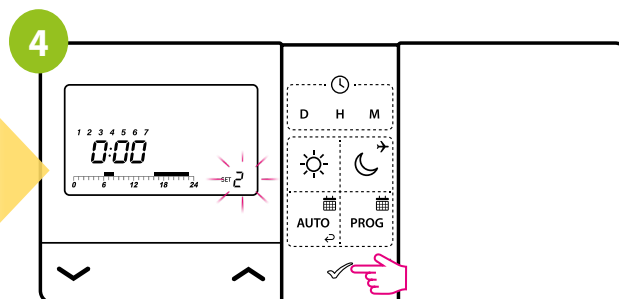

Using **^** or **v** buttons choose program number (0-3).  
Confirm by **✓** button. The thermostat will proceed to program selection for the next day/days.

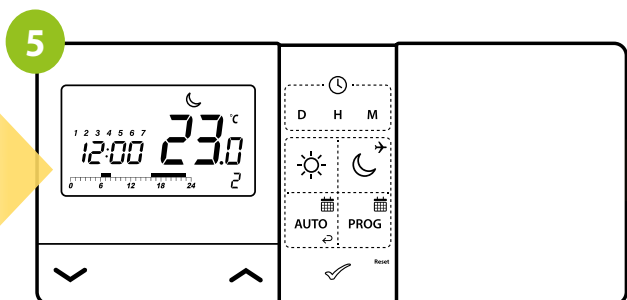

The thermostat will return to the main screen  
saving the set program.

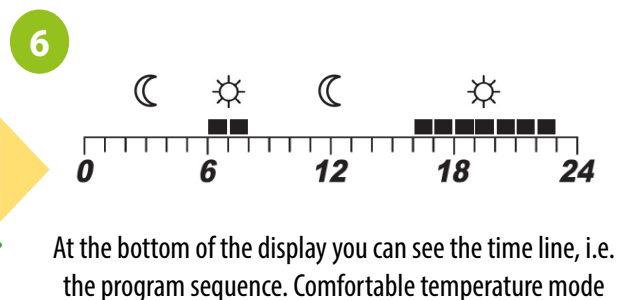

At the bottom of the display you can see the time line, i.e. the program sequence. Comfortable temperature mode (sun) is set from 6 to 8 and from 16 to 23 o'clock.



#### PLEASE NOTE!

Programs should be set for all days of the week.

### 6.3.2 Choosing and programming user programs (4-9)

In order to program your own schedule its necessary to choose user program (4-9), because only user programs are editable. Then we must draw our own timeline using Sun/Moon buttons. Thermostat will be switching between two setpoint temperatures (Comfort and Economy) which are represented by Sun and Moon icons. Switching time is represented by timeline. See steps below how to programm your own schedule:

**Example: below, program 4 will be defined for the MON - FR period with a comfort temperature from 8:00 to 16:00 and economic from 0:00 to 8:00 and 16:00 to 0:00. Programming starts from 0:00.**

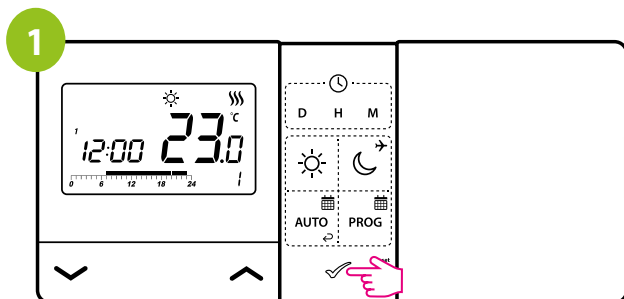

Press any button to highlight the display.

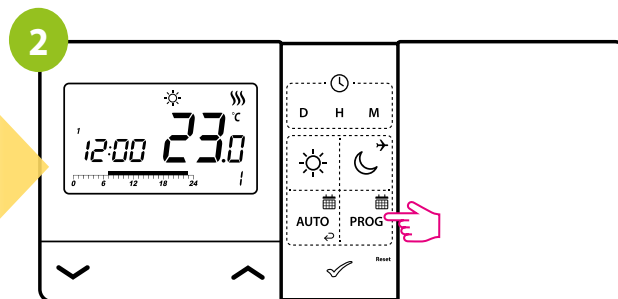

Press **PROG** button to enter the programming mode.

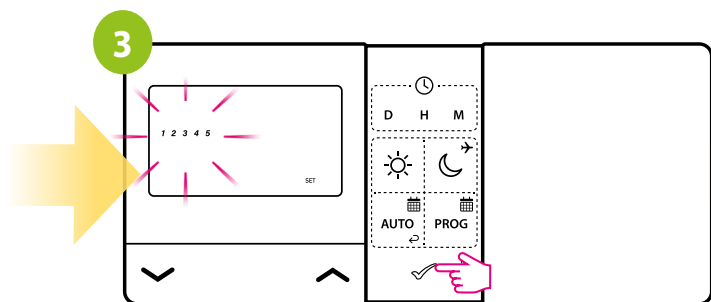

Select the week period (MON-FR) using **^** or **v** buttons. Confirm by **✓** button.

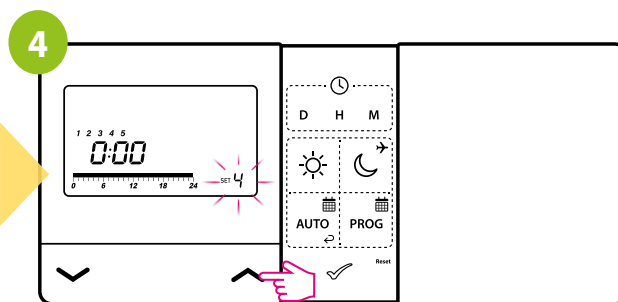

Using **^** or **v** buttons choose program number 4.

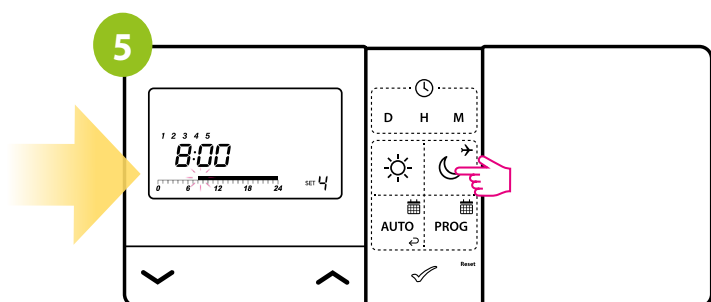

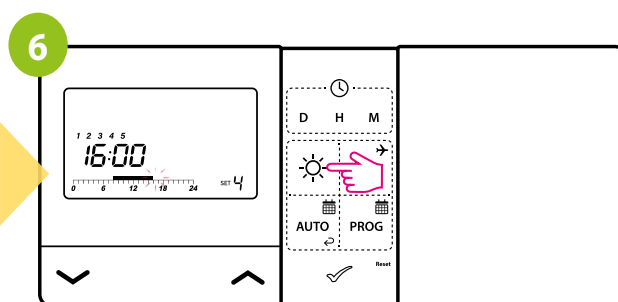

Use the button  several times to set the economic temperature until 8:00.



From 8:00 to 16:00 set comfort temperature by pressing several times  button.

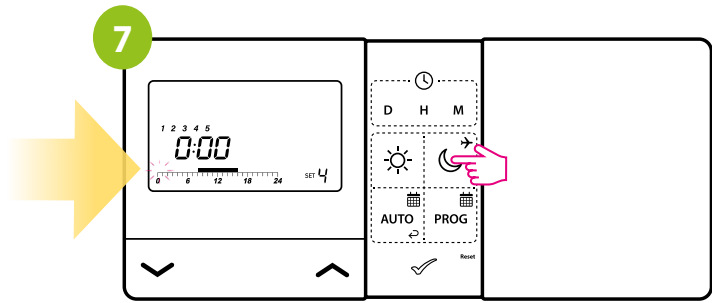



Then from 16:00 to 0:00 use the  button several times to set the economic temperature.

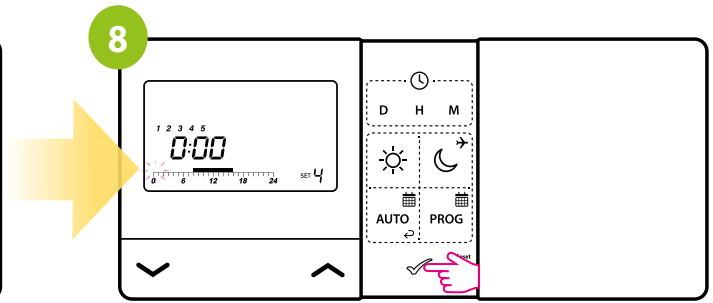

Confirm by  button.

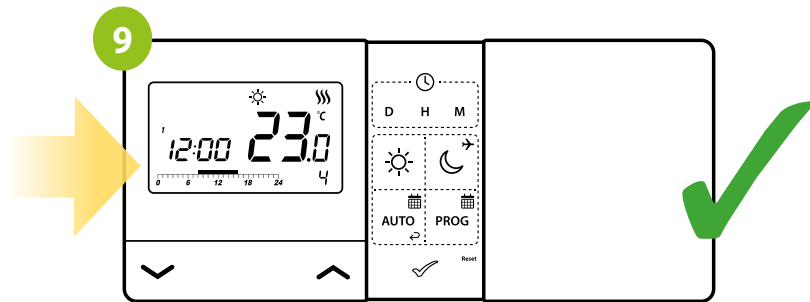

The thermostat will proceed to program selection/editing for the next day/days period. Repeat steps 4-8. The thermostat will save changes and return to the main screen.



**Please note!**

Programs 0, 1, 2, 3 are factory set and cannot be edited.

Programs 4 to 9 are user defined (editable). One program (e.g. program 4) can be assigned to several days of the week. If this program is edited, the change affects all days to which given program is assigned to.

### 6.3.3 Frost Protection program setting

Frost protection mode (program 0) protects heating system against freezing. It is recommended to set this program if you are planning a long winter trip or if you do not heat up for a long time. The thermostat will maintain a constant temperature of 7°C, thus reducing energy consumption to a minimum.

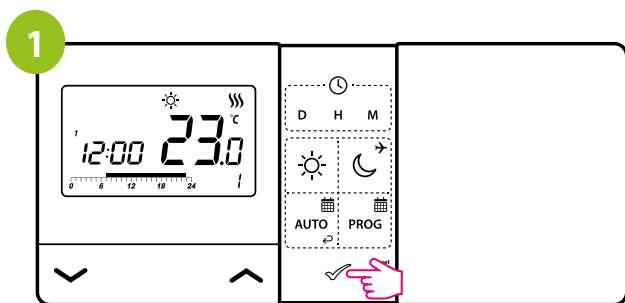

Press any button to highlight the display.

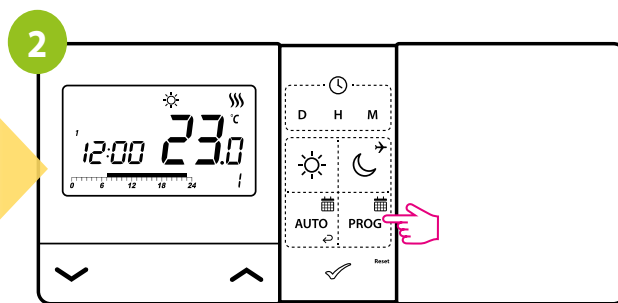

Press **PROG** button to enter the programming mode.

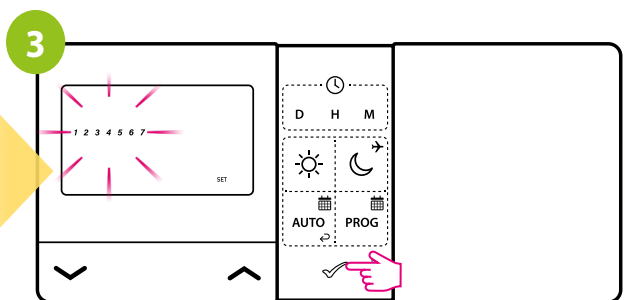

Select the week period using **^** or **v** buttons.  
Confirm by **✓** button.

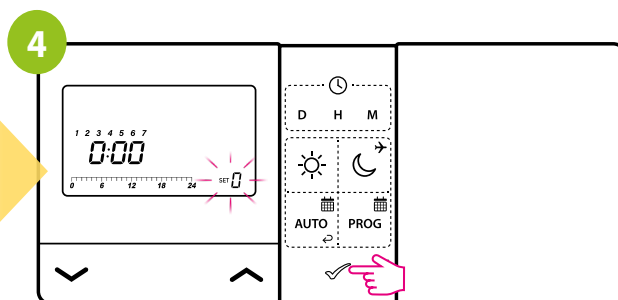

Using **^** or **v** buttons choose program number 0.  
Confirm by **✓** button. The thermostat will proceed to program selection for the next day/days.

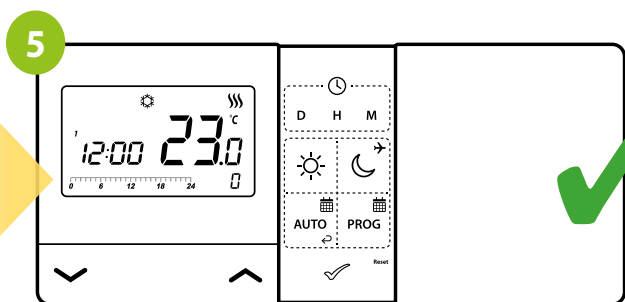

The thermostat will return to the main screen saving the set program. Snowflake - ❄️ icon will appear on the display.



#### PLEASE NOTE!

In the frost protection mode, the temperature setpoint can't be changed and it is maintained constantly at 7°C.

### 6.3.4 Temporary override mode

When thermostat is running schedule (automatic mode) we can temporarily override it by new setpoint temperature:

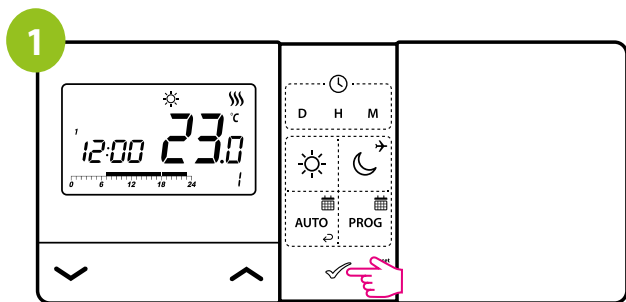

Press any button to highlight the display.

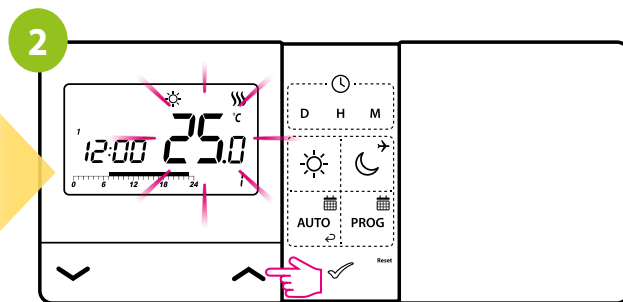

Use  $\wedge$  or  $\vee$  buttons to set the temperature.  
Confirm by  $\checkmark$  button.

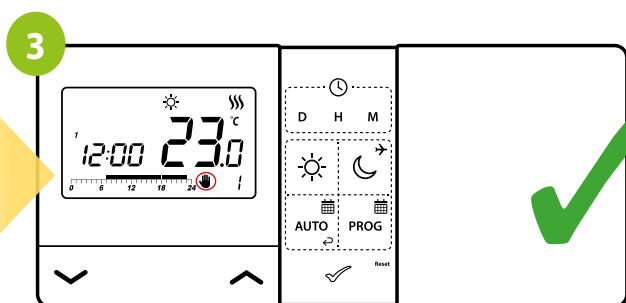

The display will show the „hand” symbol.

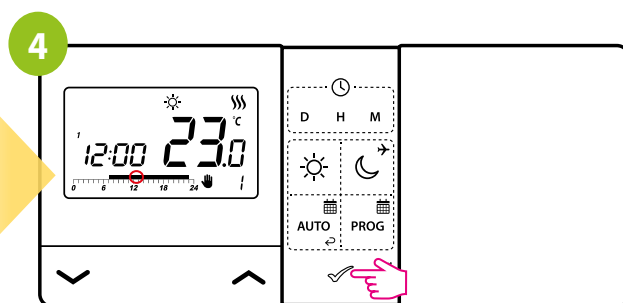

The overwritten temperature is maintained until the next  
change forced by schedule.

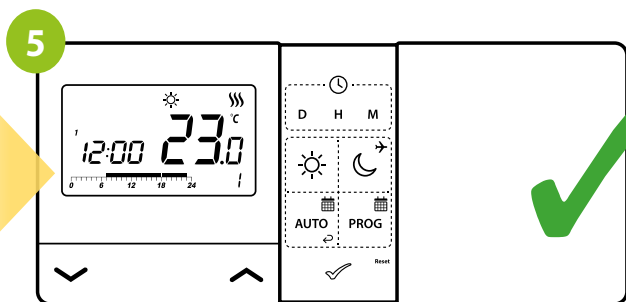

Then the „hand” symbol will disappear from the display  
and the thermostat will return to the automatic mode.

## 6.4 Second type schedule programming

There are three different configurations in a schedule type 1:

- Two different programs (timelines), separate program for working days (Monday to Friday) and separate program for weekends (Saturday to Sunday)
- Individual programs (timelines) for each day of the week
- Same program (timeline) for the whole week

Exemplary schedule setting for working days and weekend:

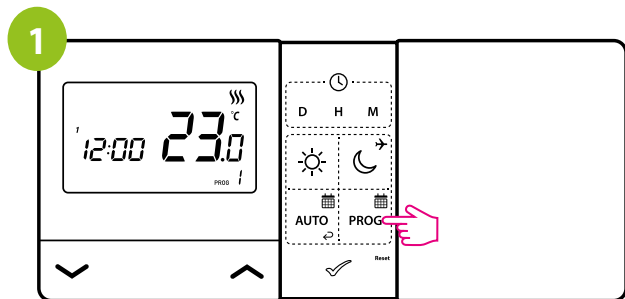

Press **PROG** button to enter the programming mode.

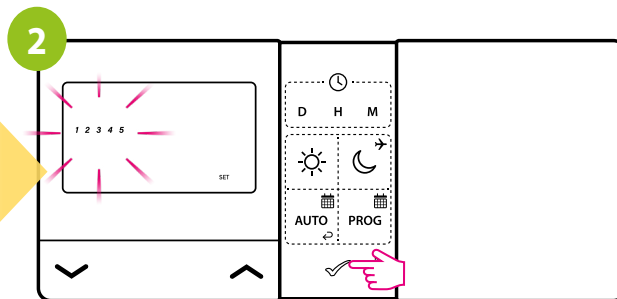

Select the week period using **^** or **v** buttons.  
Confirm by **✓** button.

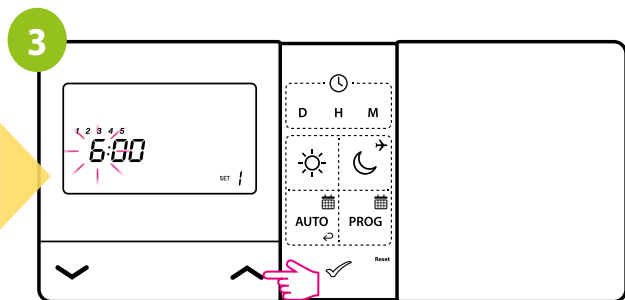

Using **^** or **v** buttons set the hour for the time period  
and then confirm by **✓** button.

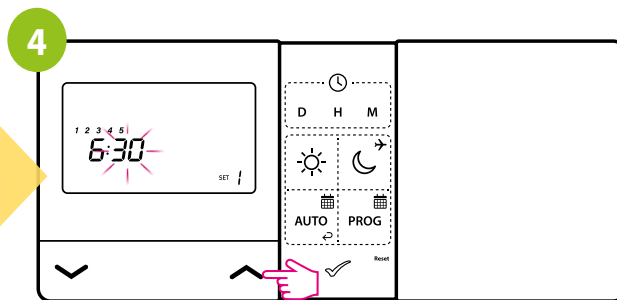

Using **^** or **v** buttons set the minutes for the time period  
and then confirm by **✓** button.

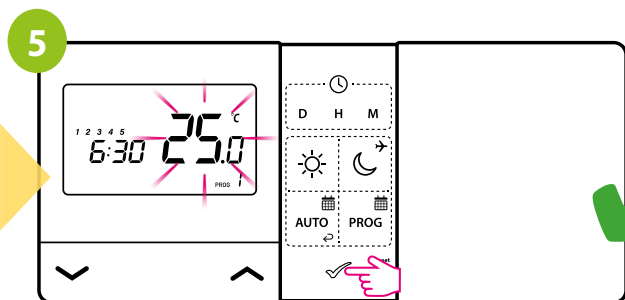

Use **^** or **v** buttons to set temperature setpoint.  
Confirm by **✓** button. The thermostat will proceed to  
program selection for the next time period  
(a maximum of 6 time periods/switching points can be set).

## 6.4.1 Temporary override mode

When thermostat is running schedule mode we can temporarily override it by setting new work mode or setpoint temperature:

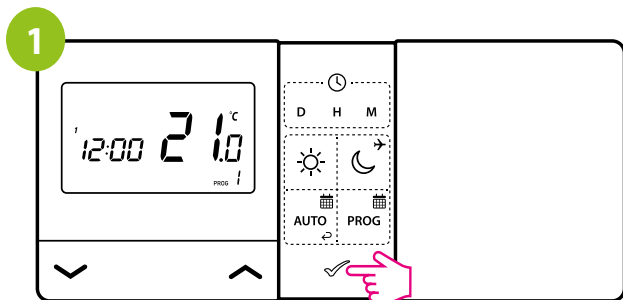

Press any button to highlight the display.

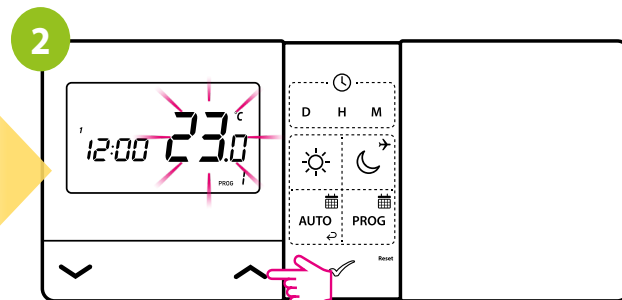

Using  $\wedge$  or  $\vee$  buttons set temperature setpoint during active AUTO mode.

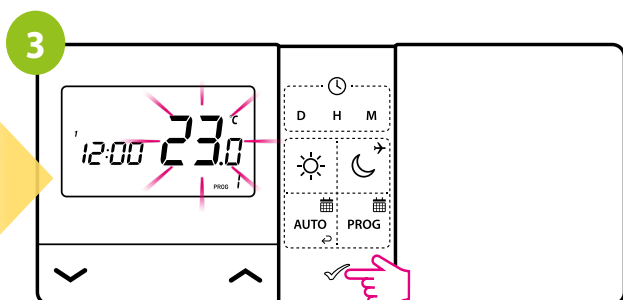

Confirm by  $\checkmark$  button.

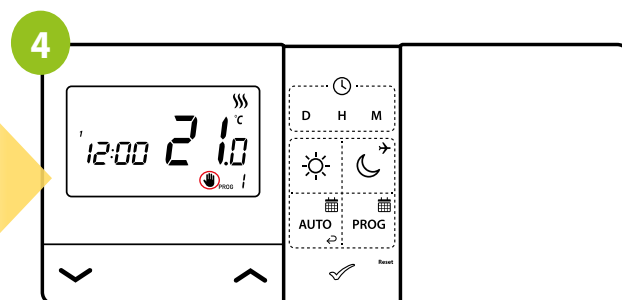

The hand icon will be displayed.  
The temperature will be maintained until the next change forced by schedule.

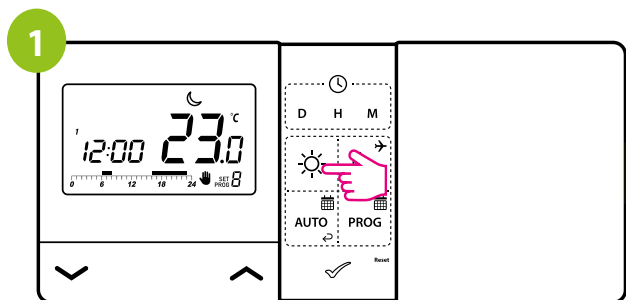

## 6.5 Party mode

In the party mode, the user can override schedule with comfort setpoint temperature by defined number of hours. To do this, follow the steps below:

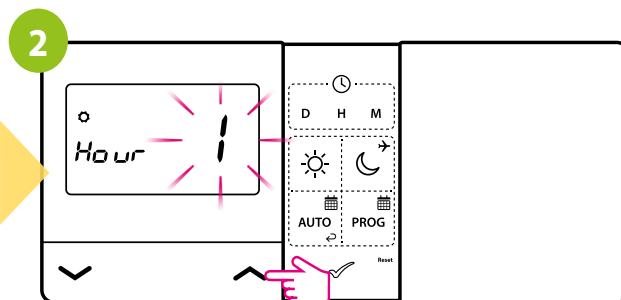

Hold the  button for 3 seconds.



Use  or  buttons to select the number of hours.

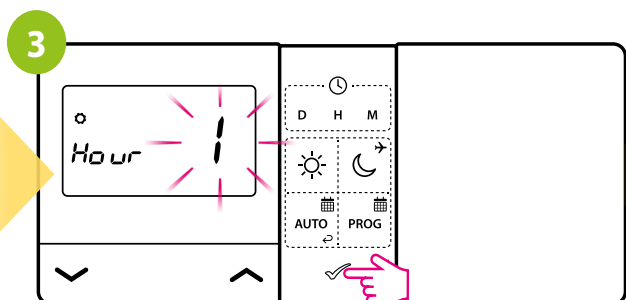

Confirm by  button.

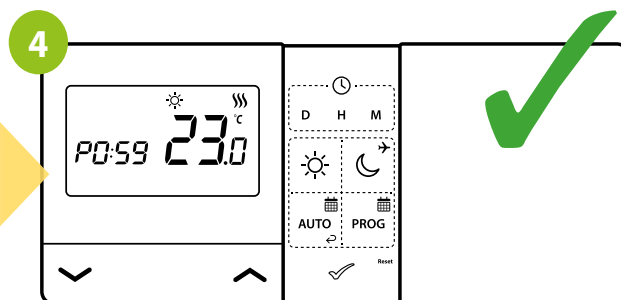



Comfort setpoint temperature will be maintained for defined number of hours. After that thermostat will go back to AUTO mode (schedule).

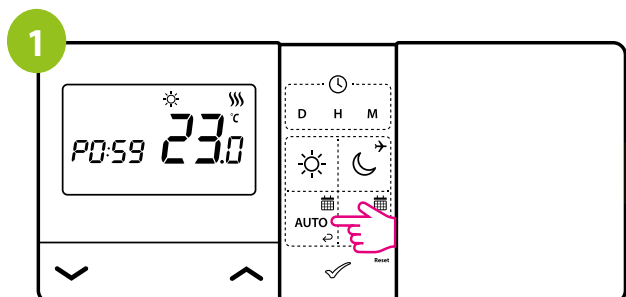

The maximum duration of party mode is 9 hours. The temperature setpoint does not change during this mode. When party mode is enabled, pressing SUN, MOON or AUTO button twice (or 3 times if backlight is OFF) will disable it and thermostat will go back to appropriate mode.

### To cancel active party mode (example):



To cancel the function, press any button to turn on backlight and then press 2 times  button.

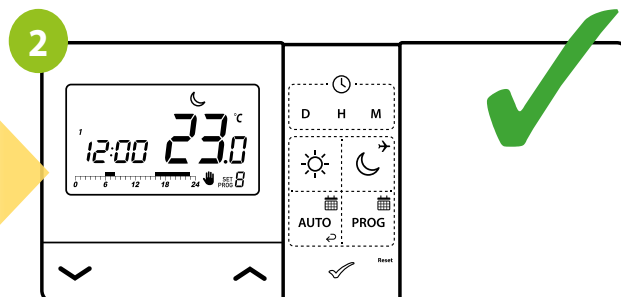

The thermostat will stop party mode and will return to schedule (Auto mode).

## 6.6 Holiday mode

Holiday mode is a special program temperature setpoint which thermostat will maintain for specified days. During holiday mode thermostat is maintaining frost protection setpoint temperature. To set holiday mode, follow the steps below:

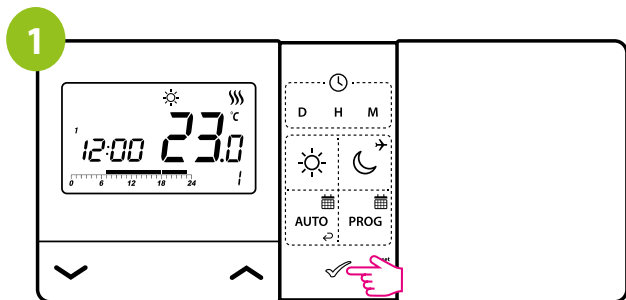

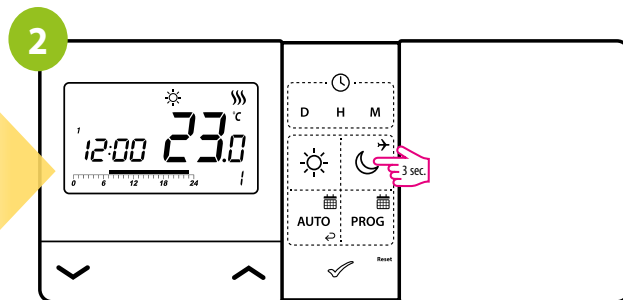

Press any button to highlight the display.

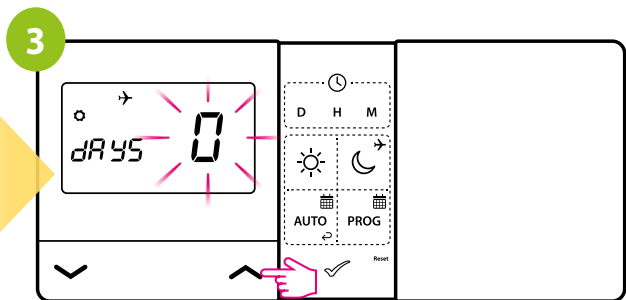

Press and hold  button for 3 seconds.



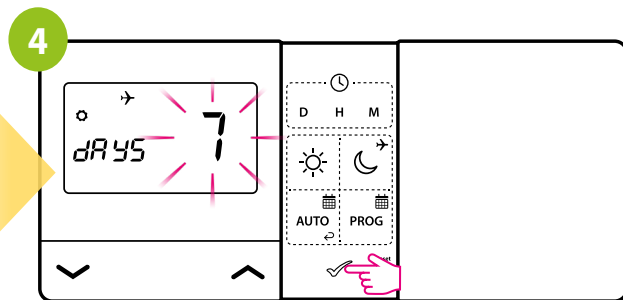

Use  or  buttons to select duration of the holiday mode (in days).

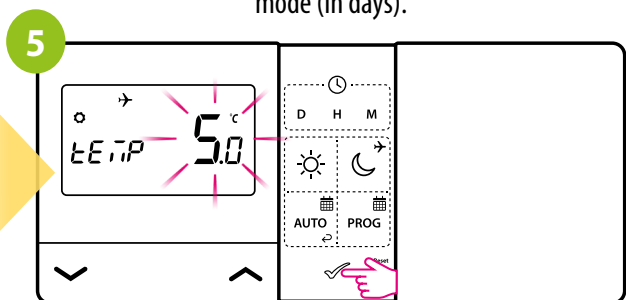

Confirm by  button.



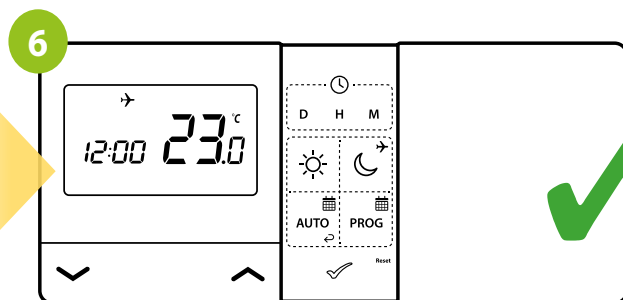

Use  or  buttons to set temperature setpoint which thermostat will maintain for defined number of days.  
Confirm by  button.

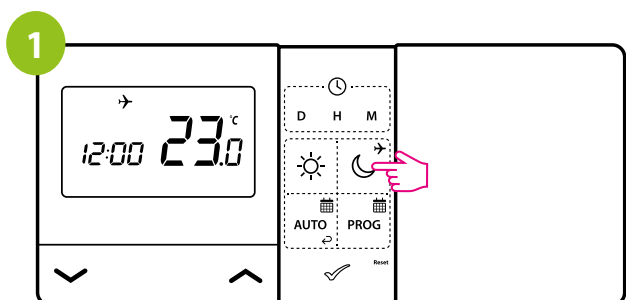

The thermostat is working in holiday mode. Plane icon is on the display.

### TO STOP HOLIDAY MODE:



Press  button.

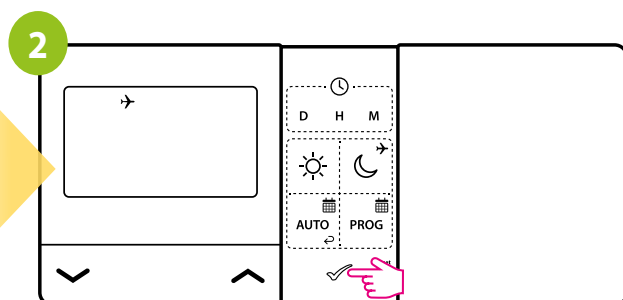

Confirm by  button.

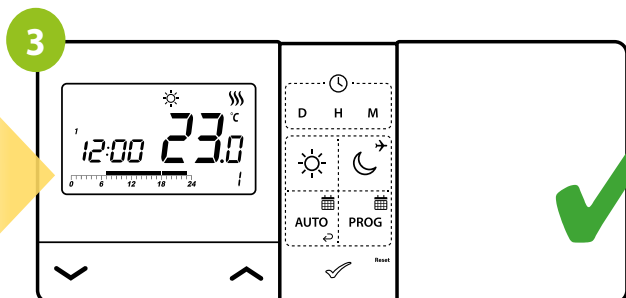

The thermostat will return to the previous mode.

## 6.7 Key lock function

To LOCK the thermostat keys, follow the steps below:

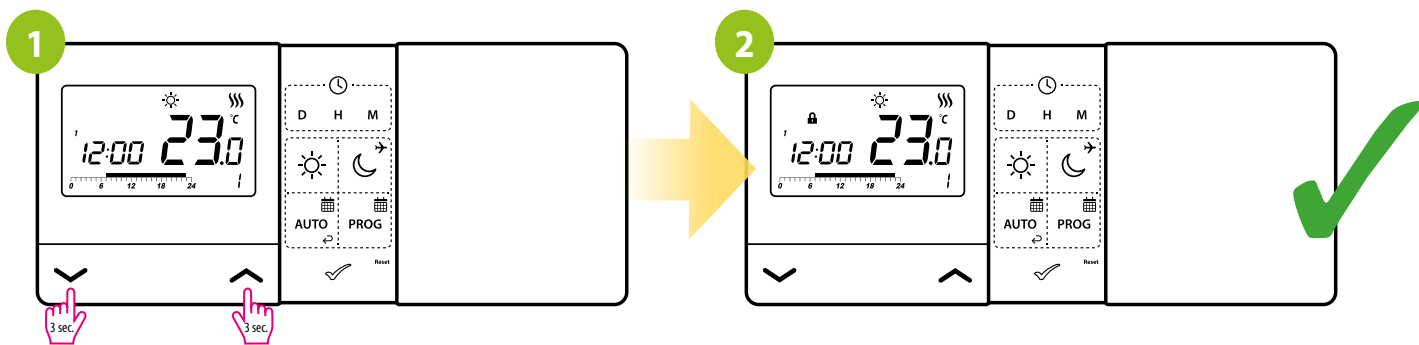



Press and hold  and  buttons for 3 seconds.

A lock icon will appear on the screen.  
The buttons on the thermostat have been locked.

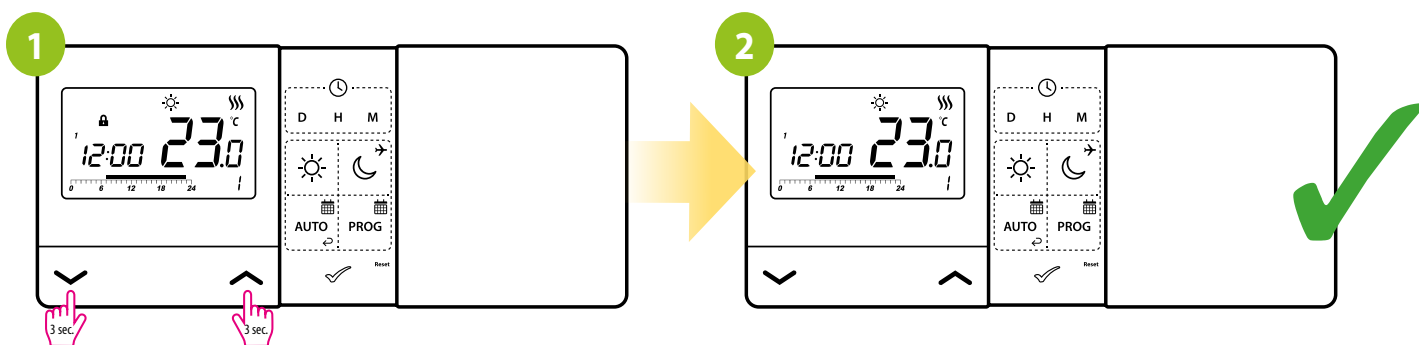
To UNLOCK the thermostat keys, follow these steps:



Press and hold  and  buttons again for 3 seconds.

The lock icon will disappear from the screen.  
The buttons on the thermostat have been unlocked.



The user has the option to set a PIN code, which he will have to enter each time he wants to unlock the buttons of the thermostat. To set a PIN code, go to parameter P12 (please refer to „Installer settings“ section).



## 7. Installer settings

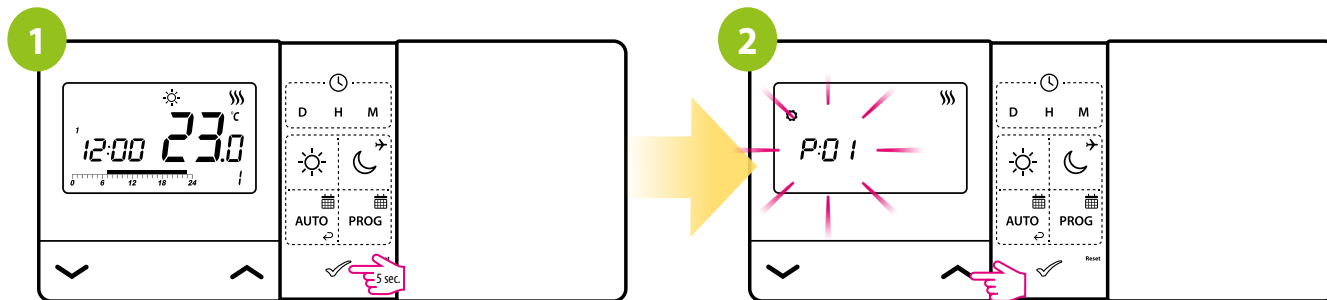

Press and hold ✓ button for 5 seconds.

You are in the installer mode. Use ^ or v buttons to move between parameters. Enter the parameter by ✓ button. Edit the parameter using ^ or v button. Confirm the new parameter value with the ✓ button.

### INSTALLER PARAMETERS:

Pxx	Function	Value	Description	Default value
P01	Heating/Cooling mode selection	☸	Cooling	☸
		☸	Heating	
P02	Control method temperature	1	SPAN ±0,25°C	1
		2	SPAN ±0,5°C	
		3	TPI for Underfloor Heating	
		4	TPI for Radiators	
		5	TPI for Electrical Heating	
P03	Display temperature resolution	0,5°C	This parameter specifies the accuracy of the displayed (measured) temperature.	0,5°C
		0,1°C		
P04	Offset temperature	-3.5°C to +3.5°C	If the thermostat indicates wrong temperature, you can correct it by ± 3.5°C	0°C
P05	Relay type	NO	Normally Open type of relay	NO
		NC	Normally Closed type of relay	
P06	Clock format	24h	24 hour	24h
		12h	12 hour	
P07	Temperature Scale	°C	Celsius	°C
		°F	Fahrenheit	
P08	Minimum setpoint	5°C - 34,5°C	Minimum heating / cooling temperature that can be set	5°C
P09	Maximum setpoint	5,5°C - 35°C	Maximum heating / cooling temperature that can be set	35°C

<b>Pxx</b>	<b>Function</b>	<b>Value</b>	<b>Description</b>	<b>Default value</b>
P10	Key sound	NO	Off	YES
		YES	On	
P11	PIN code. Require PIN code for editing Service Parameters.	NO	Disabled	NO
		PIN	Enabled	
P12	Require a PIN code to unlock the,Key Lock'.	NO	Function disabled	NO
		YES	Function enabled	
CLR	Clear settings factory reset	NO	No action	NO
		YES	Factory Reset	

## 8. Thermostat's reboot

There is a small hole on the right side of the ✓ button. This is the REBOOT button. Pressing this key will restart the thermostat and reset the time.

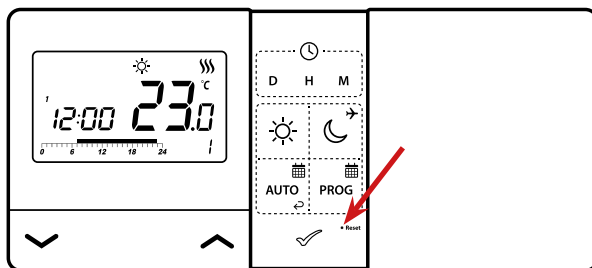

## 9. Clear settings - factory reset

To perform factory reset (which will remove all user/installer settings), use the CLR parameter from installer parameters menu. After confirming the parameter, the thermostat will restore the default settings.

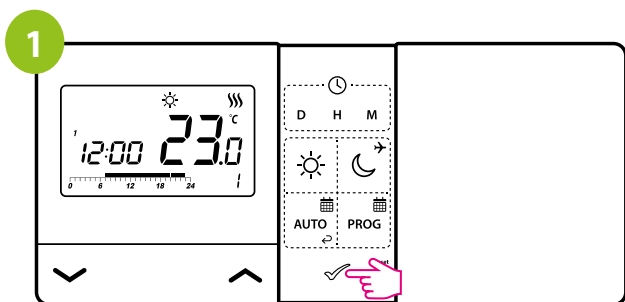

Press any button to highlight the display.

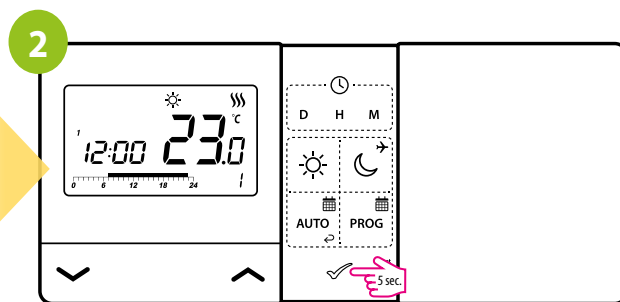

Press and hold ✓ button for 5 seconds.

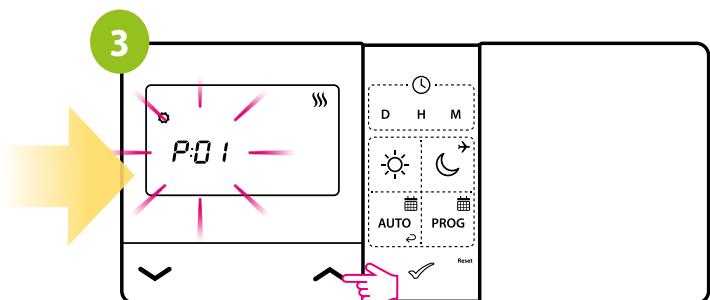

Use ^ or v buttons to move to CLR parameter.

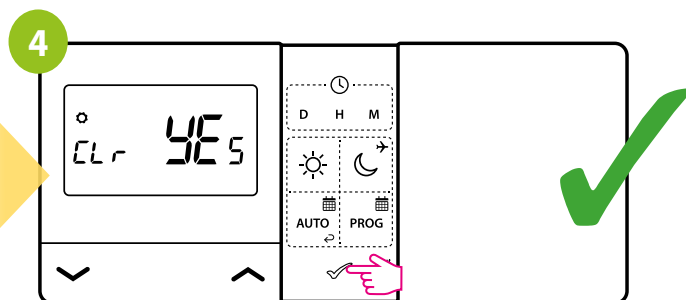

Confirm the new parameter value with the ✓ button.

## 10. Cleaning and Maintenance

The **E901 thermostat** requires no special maintenance. Periodically, the outer casing can be wiped clean using a dry cloth (please DO NOT use solvents, polishes, detergents or abrasive cleaners, as these can damage the thermostat). There are no user serviceable parts within the unit; any servicing or repairs could only be carried out by **ENGO Controls** or their appointed agents.

## 11. Technical Informations

Power supply	2 x AA batteries
Rating max	5 (3) A
Output signal	NO/COM relay
Temperature range	5 - 35°C
Display temperature accuracy	0.1°C or 0.5°C
Control algorithm	TPI or Hysteresis: $\pm 0.25^\circ\text{C}$ and $\pm 0.5^\circ\text{C}$
Communication	Wired
Dimension [mm]	150 x 84 x 22

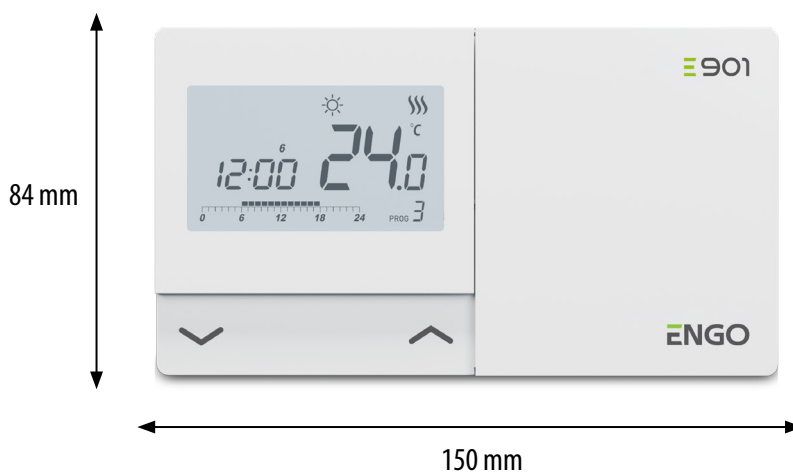

## 12. Warranty

ENGO Controls warrants this product to be free from any defects in material or workmanship and to perform as specified for a period of five years from the date of installation. ENGO Controls reserves the sole responsibility for breach of this warranty by repairing or replacing the defective product. This product includes software that matches the distributor's identification at the time of sale. The manufacturer / distributor provides a guarantee covering all functions and specifics of the product in accordance with this marking. The distributor's warranty does not cover the correct operation of the functions and features available as a result of a product software update.

<p><b>Customer Name:</b> .....</p> <p><b>Customer Address:</b> .....</p> <p>..... <b>Post Code:</b> .....</p> <p><b>Tel No:</b> ..... <b>Email:</b> .....</p>
<p><b>Company Name:</b> .....</p> <p><b>Tel No:</b> ..... <b>Email:</b> .....</p> <p><b>Installation Date:</b> .....</p> <p><b>Installer Name:</b> .....</p> <p><b>Installer Signature:</b> .....</p>



Ver. 9.1

Date of issue: X 2024

**Producer:**

Engo Controls Sp z o.o. Sp. k.  
43-262 Kobielice  
4 Rolna St.  
Poland

[www.engocontrols.com](http://www.engocontrols.com)